

# ***APPENDIX D***

---

*Water and Wastewater Feasibility Study and Culvert Flow  
Capacity Estimate*

# Graton Rancheria Hotel and Casino Project Water and Wastewater Feasibility Study

December 2006



Prepared for:  
**Station Casinos**  
Rocklin, California



## TABLE OF CONTENTS

<b>SECTION 1:</b>	<b>INTRODUCTION.....</b>	<b>1</b>
1.1	Proposed Project Sites.....	1
1.2	Report Organization .....	2
<b>SECTION 2:</b>	<b>PROJECT ALTERNATIVES .....</b>	<b>3</b>
2.1	Alternative A .....	3
2.1.1	Water Flow Requirements.....	3
2.1.2	Water Supply .....	4
2.1.3	Wastewater.....	5
2.1.4	Treatment .....	7
2.1.5	Effluent Disposal .....	13
2.2	Alternative B .....	22
2.2.1	Water Supply .....	22
2.2.2	Wastewater.....	22
2.2.3	Effluent Disposal .....	22
2.3	Alternative C.....	23
2.3.1	Water Supply .....	23
2.3.2	Wastewater.....	23
2.3.3	Effluent Disposal .....	23
2.4	Alternative D .....	24
2.4.1	Water Supply .....	24
2.4.2	Wastewater.....	24
2.4.3	Effluent Disposal .....	26
2.5	Alternative E.....	26
2.5.1	Water Supply .....	26
2.5.2	Wastewater.....	27
2.5.3	Effluent Disposal .....	28
2.6	Alternative F .....	29
2.6.1	Water Supply .....	29
2.6.2	Wastewater.....	29
2.6.3	Effluent Disposal .....	30
2.6.4	Effluent Disposal Summary .....	33
2.7	Alternative G .....	34
2.7.1	Water Supply .....	34
2.7.2	Wastewater.....	35
2.7.3	Effluent Disposal .....	35
<b>SECTION 3:</b>	<b>LOCAL HYDROGEOLOGY .....</b>	<b>36</b>
3.1	Rohnert Park Hydrogeology .....	36
3.1.1	Glen Ellen Formation .....	36
3.1.2	Merced Formation.....	38
3.1.3	Sonoma Volcanics.....	39
3.2	Sonoma I Hydrogeology .....	40
3.2.1	Artificial Fill (af, afbm) .....	41
3.2.2	Alluvium (Qal, Qhf, Qpf).....	41
3.2.3	Bay Mud (Qhbm).....	41
3.2.4	Upper Petaluma Formation (Tpu).....	42

---

<b>SECTION 4:</b>	<b>BACKGROUND AND REGULATORY ISSUES.....</b>	<b>43</b>
4.1	Water Supply .....	43
4.1.1	City of Rohnert Park .....	43
4.1.2	Outside Agency Allocation .....	44
4.1.3	Groundwater Resources .....	44
4.1.4	City Wells .....	45
4.2	Recycled Water .....	48
4.3	Wastewater .....	49
4.3.1	Baseline Monitoring Program.....	49
4.3.2	Sludge Disposal .....	52
<b>SECTION 5:</b>	<b>WATER FACILITY REQUIREMENTS .....</b>	<b>53</b>
5.1	Water Production Wells .....	53
5.2	Water Treatment Plant .....	54
5.3	Water Storage Tank and Pump Station .....	55
<b>SECTION 6:</b>	<b>WASTEWATER FACILITY REQUIREMENTS .....</b>	<b>56</b>
6.1	Wastewater Collection System .....	56
6.2	Wastewater Treatment Plant .....	57
6.2.1	Headworks .....	57
6.2.2	Immersed Membrane Bioreactor System .....	57
6.2.3	UV Disinfection .....	59
6.2.4	Chlorine Disinfection .....	59
6.3	Discharge Facilities .....	60
6.4	Operations and Maintenance .....	60
6.5	Recycled Water .....	61
6.5.1	Storage Tank.....	61
6.5.2	Recycled Water Pump Station .....	61
6.5.3	On-site Water Reuse Facilities .....	62
6.5.4	Seasonal Storage Ponds .....	62
6.5.5	Spray Field Irrigation System .....	62
<b>SECTION 7:</b>	<b>RECOMMENDATIONS.....</b>	<b>64</b>
7.1	Water Supply .....	64
7.2	Wastewater Handling.....	64
<b>SECTION 8:</b>	<b>REFERENCES .....</b>	<b>65</b>



## LIST OF TABLES

Table 2-1: Projected Water Supply Requirements.....	3
Table 2-2: Typical WWTP Influent Water Quality (mg/L).....	6
Table 2-3: Projected Wastewater Flows for Alternative A.....	6
Table 2-4: WWTP Design Flows for Alternative A.....	7
Table 2-5: Analysis of Laguna WWTP Influent Water Quality with Raw Sewage from the Project .....	8
Table 2-6: Projected Northwest Specific Plan Sewage Flows in Project Area Only.....	9
Table 2-7: Estimated On-Site Seasonal Disposal Requirements.....	15
Table 2-8: Typical Irrigation Demands for Regional Turf Grasses.....	16
Table 2-9: Daily Average Streamflow at USGS Gauging Station #11465680.....	19
Table 2-10: Beneficial Uses for the Laguna de Santa Rosa.....	20
Table 2-11: Water Quality Objectives of Receiving Waters.....	21
Table 2-14: Projected Water Supply Requirements for Alternative D.....	24
Table 2-15: Projected Wastewater Flows for Alternative D.....	25
Table 2-16: Projected Design Flows for Alternative D.....	25
Table 2-17: Seasonal Disposal Strategy for Alternative D.....	26
Table 2-18: Projected Water Supply Requirements for Alternative E.....	27
Table 2-19: Projected WWTP Influent Water Quality – Alternative E (mg/L).....	27
Table 2-20: Projected Wastewater Flows for Alternative E.....	27
Table 2-21: Design Flows for Alternative E.....	28
Table 2-22: Seasonal Disposal Strategy for Alternative E.....	29
Table 2-23: Seasonal Disposal Strategy for Alternative F.....	31
Table 2-24: Beneficial Uses for the Petaluma River.....	33
Table 2-25: Water Quality Objectives of Receiving Waters.....	33
Table 4-1: Selected City Well Properties.....	45
Table 4-2: Receiving Water Quality Baseline Monitoring Program.....	50
Table 4-3: 2004 Analytical Results for the Laguna de Santa Rosa at Stony Point Road Bridge	51
Table 4-4: California Toxics Rule and Trace Metals Laboratory Tests.....	51
Table 5-1: Recommended Water Production Well Design Criteria.....	54
Table 5-2: Recommended Water Treatment Plant Design Criteria.....	55
Table 5-3: Recommended Water Storage Tank and Pump Station Design Criteria.....	55
Table 6-1: Recommended Sanitary Sewage Lift Station Design Criteria.....	56
Table 6-2: Headworks Design Criteria.....	57
Table 6-3: MBR Design Criteria.....	58
Table 6-4: UV Disinfection Design Criteria.....	59
Table 6-6: Recycled Water Storage Tank Design Criteria.....	61

## LIST OF FIGURES

Figure 1-1: Alternative A Location Map.....	following page 2
Figure 1-2: Alternatives B, C, D & E Location Map.....	following page 2
Figure 1-3: Alternative F Location Map.....	following page 2
Figure 2-1: Alternative A – Wet Season Discharge .....	following page 4
Figure 2-2: Laguna Subregional WWTP Sewer Force Main Connection.....	following page 10
Figure 2-3: Wastewater Treatment Process Flow Diagram.....	following page 12
Figure 2-4: Alternative A – Wet Season Storage .....	following page 14
Figure 2-5: Alternative B – Wet Season Discharge .....	following page 22
Figure 2-6: Alternative B – Wet Season Storage .....	following page 24
Figure 2-7: Alternative C – Wet Season Discharge .....	following page 24
Figure 2-8: Alternative C – Wet Season Storage.....	following page 24
Figure 2-9: Alternative D – Wet Season Discharge .....	following page 24
Figure 2-10: Alternative D – Wet Season Storage.....	following page 26
Figure 2-11: Alternative E – Wet Season Discharge .....	following page 26
Figure 2-12: Alternative E – Wet Season Storage.....	following page 30
Figure 2-13: Alternative F – Wet Season Discharge.....	following page 30
Figure 2-14: Alternative F – Wet Season Storage .....	following page 32
Figure 4-1: Local Groundwater Wells Site Map .....	following page 46
Figure 5-1: Preliminary Water Treatment Plant Layout.....	following page 54
Figure 5-2: Preliminary Process Flow Diagram .....	following page 54
Figure 5-3: Typical Potable Water Storage Tank.....	following page 56
Figure 6-1: Typical Influent Lift Station .....	following page 56
Figure 6-2: Typical Headworks Plan and Section.....	following page 58
Figure 6-3: Typical Wastewater Treatment Facility Plan.....	following page 58
Figure 6-4: Typical MBR Process Operations Building Floor Plan .....	following page 60
Figure 6-5: Typical Recycled Water Storage Tank.....	following page 62

## APPENDIX

Appendix A: Laguna de Santa Rosa Water Quality Results
Appendix B: Spray Field and Seasonal Storage Pond Sizing Calculations
Appendix C: Equalization and Emergency Storage Sizing Calculations

## SECTION 1: INTRODUCTION

HydroScience Engineers (HSe) was retained by Station Casinos to complete a feasibility study evaluating the regulatory, technical, and engineering issues associated with supplying water and handling wastewater from the proposed Graton Rancheria Hotel and Casino Project (Project). The objectives of this water and wastewater feasibility study are:

- To estimate the proposed Project's water supply and wastewater disposal requirements;
- To describe the facilities that would be required to supply the required water, and treat the required amount of wastewater;
- To develop a strategy for disposing of wastewater generated by the Project; and
- To identify applicable water and wastewater permitting issues for the proposed Project.

This report evaluates these objectives for six potential project alternatives, as well as a no project alternative. This document describes each alternative's water supply and wastewater requirements, identifies projected flows and demands, and evaluates alternative effluent disposal strategies. Sections 4 through 7 present a plan summarizing the facilities required to meet the Project objectives for the preferred alternative.

### 1.1 Proposed Project Sites

Three alternative site locations were identified for the alternatives identified for this project.

The Wilfred site is for Alternative A, which encompasses pieces of multiple sites, including:

1. A 68-acre site bordered roughly by Labath Avenue and a new unnamed street to the east, Business Park Drive to the South, Langner to the west, and Wilfred Avenue to the north.
2. A 4.7-acre parcel on Park Court, adjacent to the southwest corner of the 68-acre site
3. The Williamson Act lands located on the southern half of the 360-acre site, which is described below.

**Figure 1-1** shows the location for this site, which is utilized for Alternative A.

The second site partially overlaps the first site, and is referred to as the Stony Point site. This 360-acre site resides on unincorporated land in central Sonoma County. The property is bounded by the Laguna de Santa Rosa (Laguna) to the south, Stony Point Road to the west, Wilfred Avenue to the north, and Dowdell Avenue to the east, and is bisected by Rohnert Park Expressway and the Bellevue-Wilfred Flood Control Channel (Bellevue Channel). The land is currently utilized as irrigated farmland, pasture land, and to dispose of recycled water from the City of Santa Rosa's Laguna Subregional Wastewater Treatment Facility (Laguna WWTP). This site is the basis for Alternatives B through E. A map showing the location of this site is included as **Figure 1-2**.

The third site is comprised of three separate parcels, one to the west and two to the east of Lakeville Highway, north of Highway 37 in southern Sonoma County covering a total area of about 320 acres. **Figure 1-3** shows the location of these parcels, which are collectively referred to as the Lakeville site. The Petaluma River is about two miles west of the project parcels. A

number of unnamed streams, tributaries of the Petaluma River, are located within the parcels on the west side of Lakeville Highway. These areas are utilized for agricultural purposes or as open space.

## **1.2 Report Organization**

This report is divided into nine sections as described below.

- Section 1 – Introduction
- Section 2 – Project Alternatives
- Section 3 – Local Hydrogeology
- Section 4 – Background and Regulatory Issues
- Section 5 – Water Facility Requirements
- Section 6 – Wastewater Facility Requirements
- Section 7 – Recommendations
- Section 8 – References

## SECTION 2: PROJECT ALTERNATIVES

The following section provides a summary of each of the six alternatives, as well as the no project alternative. For each alternative, the following information is summarized:

- Project Description
- Wastewater, including discussions about influent water quality, wastewater flows, wastewater treatment options, and effluent disposal options
- Water Supply
- Recycled Water

Each alternative is individually described below.

### 2.1 Alternative A

Alternative A would include a gaming and entertainment facility at the location identified in **Figure 1-1**. This project would have a total footprint of approximately 762,000 ft<sup>2</sup>, including a casino, multiple restaurants and bars, a 1,500 seat showroom, banquet rooms, and a 300-room hotel. The entrances to the Wilfred site would be from Langner Ave. and Labath Ave. Approximately 6,000 on-site parking spaces will be located on the site around the gaming facility, and would include a parking structure on the west side of Labath Ave. A map showing a site plan for Alternative A is included as **Figure 2-1**.

#### 2.1.1 Water Flow Requirements

Preliminary projections of the water supply needed to reliably meet water demand for Alternative A are summarized in **Table 2-1**. These projections are based on average wastewater flows and include a 15% allowance for system losses as well as a safety factor to ensure adequate supply. These numbers are preliminary and are for planning purposes only.

**Table 2-1: Projected Water Supply Requirements**

Water Supply Requirement without Recycled Water (gpm)	Water Supply Requirement with Recycled Water (gpm)	Minimum Recommended Firm Water Supply (gpm)
250	200	250

gpm = gallons per minute

A “firm” water source is considered that which can be supplied by the system with the single largest source of service, in a redundant system. The “firm” water supply is that which is required 24 hours a day, 365-day a year, and is the Maximum Day Demand for the project. Water system redundancy may be achieved in a variety of ways – in a groundwater system, multiple wells or another redundant source would normally be required. Diurnal peaks, fire flow, and other peak demands may be met with storage tanks.

The experience of other similarly sized gaming and entertainment facilities has shown that water demands can be significantly reduced when recycled water is introduced as an alternative water supply source. Water supply requirements, including the use of recycled water, were calculated

assuming recycled water would be utilized for toilet flushing, landscape irrigation, cooling tower make-up and other approved uses.

The average water demand is projected to be around 165 gpm. This average demand was estimated using the projected wastewater flows including a 15% allowance for system losses as well as an expected 20% reduction based on the assumed use of recycled water as discussed above. This demand is expected to be more representative of typical water usage. Peak water demands, which would typically occur on the weekends, were calculated to be approximately 226 gpm using similar methodology.

In addition to the use of recycled water, the project is also expected to be designed and managed to minimize potable water usage. Recommended water conservation measures include low flow fixtures, voluntary towel re-use, central plant optimization, etc. To facilitate this, sub-metering of water for each of the uses within the Project will discourage waste and help identify areas where consumption can be reduced. Employee training and participation, regular maintenance, and customer education are all expected to also help reduce water use.

Fire flow requirements (or guidelines) are set by the local fire authorities, based on the building's use and classification. Storage requirements for casinos are generally controlled by fire protection requirements, and not by domestic peaking requirements. Storage requirements will be determined upon issuance of the fire flow and duration requirement. These requirements are not identified in this document.

### **2.1.2 Water Supply**

The Project will require both a potable and irrigation water supply for use within the Project. Potable water could be obtained through the construction of on-site groundwater wells or a connection to the City of Rohnert Park potable water distribution system. Irrigation water could be obtained either through 1) construction of an on-site wastewater treatment plant (discussed in *Section 2.1.3*) and the reuse of effluent from that plant as recycled water, or 2) connection to the City of Santa Rosa recycled water distribution system, or 3) use of groundwater, or 4) use of potable water.

It is expected that groundwater is available within the Wilfred site. There are several wells either nearby or within the Wilfred site that have historically provided groundwater in high quantity and generally with good quality. It is possible that groundwater treatment may be required to remove iron and/or manganese. Additional information about groundwater supplies is included in *Section 4.1*.

The City of Rohnert Park indicated in their Water Supply Assessment, that they have sufficient water supplies for the City through 2025 for all years. The City water supplies include groundwater, recycled water, and surface water from SCWA. The difference between the total available supply and the potential demand is approximately 1,200 AFY in multiple dry years. It was noted that a water supply agreement would be required between the Project and the City, since this connection would be located outside of the City limits. This agreement may be subject to additional environmental review or other external factors.

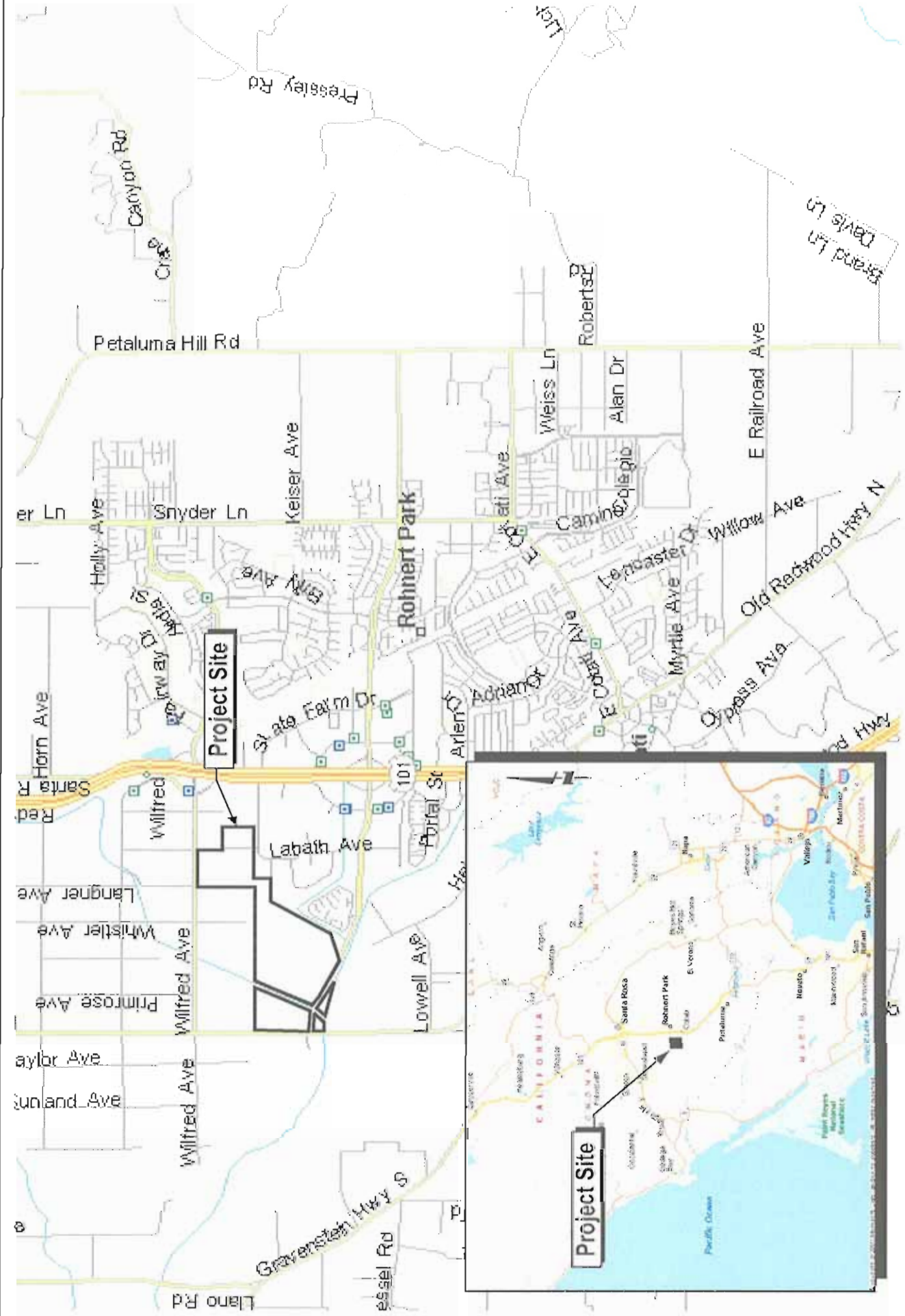
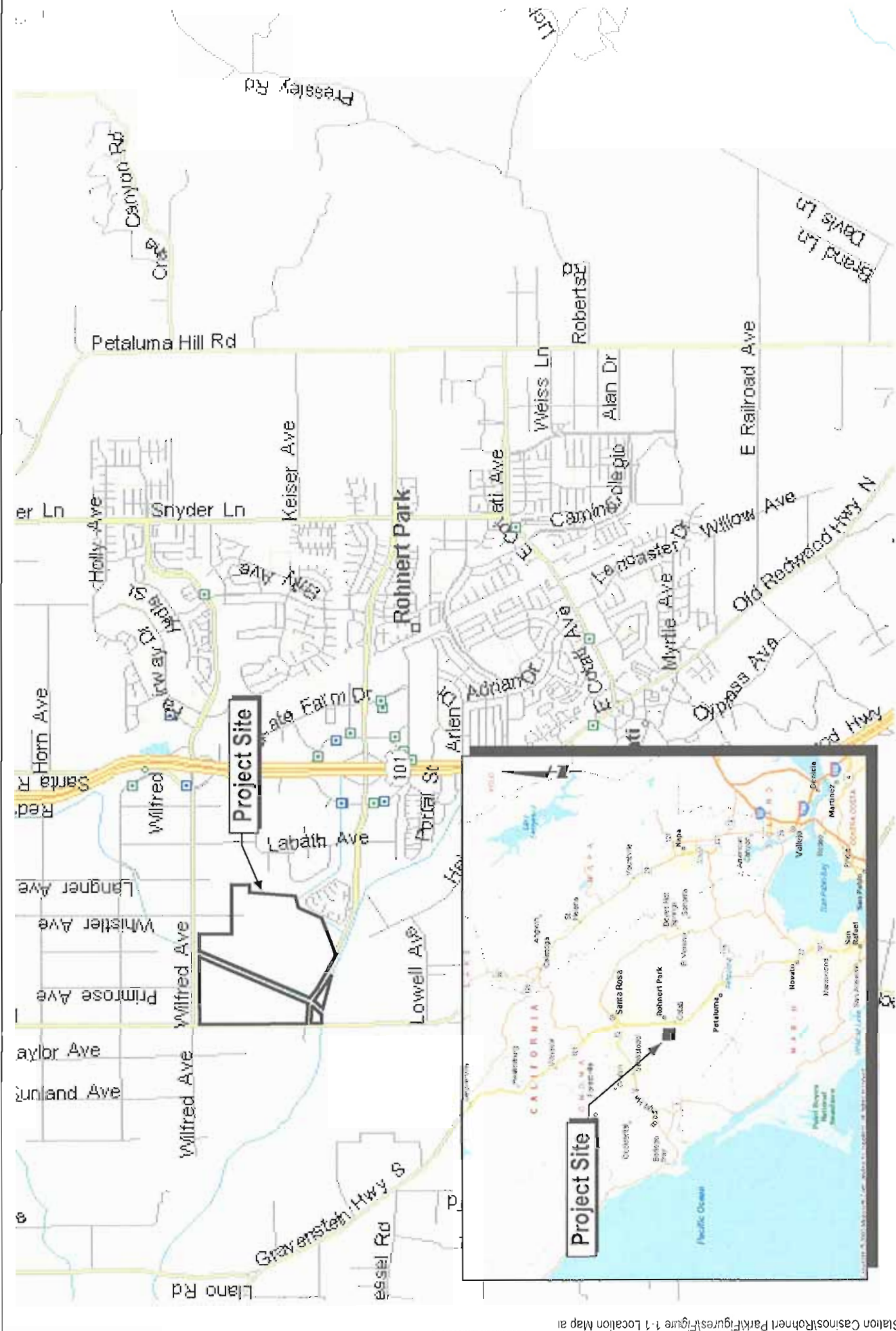

**FIGURE 1-1**  
 STATION CASINOS  
 GRATON RANCHERIA HOTEL AND CASINO PROJECT  
 ALTERNATIVE A LOCATION MAP



SOURCE Streets & Trips, 2004



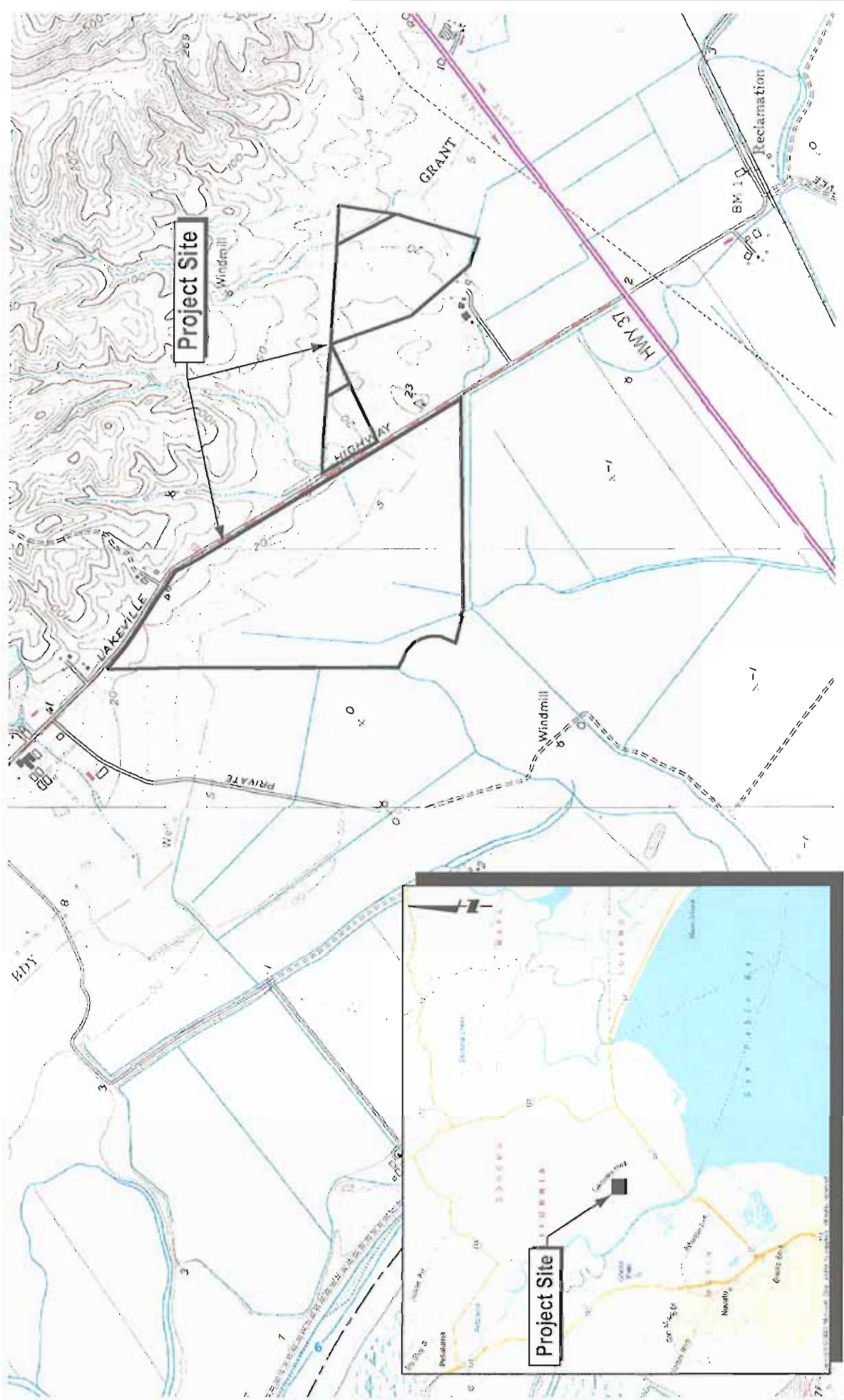

**FIGURE 1-2**  
 STATION CASINOS  
 GRATON RANCHERIA HOTEL AND CASINO PROJECT  
 ALTERNATIVES B,C,D & E LOCATION MAP



SOURCE: Streets & Trips, 2004





S:\Common\Projects\Station\_Casino\_Rohrer\_Park\ENGR\_Figures\Figure 1-2.a1

**FIGURE 1-3**  
 STATION CASINOS  
 GRATON RANCHERIA HOTEL AND CASINO PROJECT  
 ALTERNATIVE F LOCATION MAP



Sources: Streets & Trips, and TOPO!

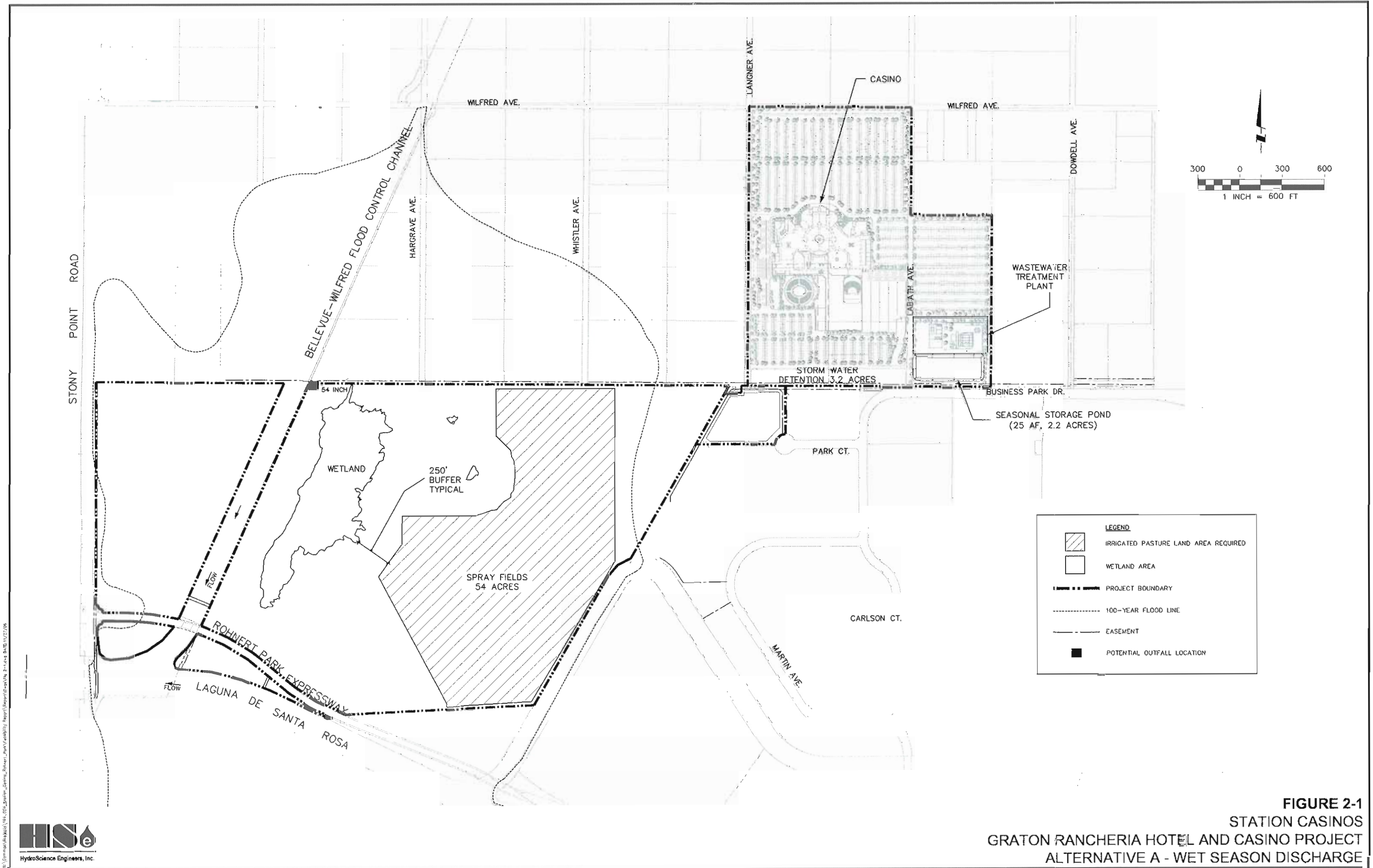

S:\Graton\GIS\MapDocs\Station\_Casinos\Station\_Casinos\_Report\Station\_Casinos\_Report.dwg, 2-1-04, DATE: 11/27/06

On October 29, 2004, the City adopted Ordinance 723, a Water Waste Ordinance. This Ordinance requires the use of recycled water when it is available and of appropriate quality. This Ordinance will assure that the recycled water supply is fully utilized where appropriate. Thus, it is unlikely that the City would provide potable water or groundwater for irrigation purposes if recycled water was available. If recycled water was not available for any reason, only then would the City be expected to consider providing potable water for irrigation.

The construction of an on-site wastewater treatment plant with tertiary level treatment would result in an available supply of recycled water that could be reused on-site. This supply would essentially be limited to what the wastewater treatment plant produces, and would be fully under the control of the Project.

Connection to the Subregional recycled water distribution system would require coordination with the City of Santa Rosa. Though recycled water pipelines bisect and are adjacent to the site, recycled water availability may be limited at times. For a new recycled water user outside of the City limits, that user would need to prepare a proposal to the City of Santa Rosa for recycled water service. This proposal format would summarize how recycled water would be used, the quantities required, operational details, as well as provide costs and benefits. The City then evaluates the proposal, and determines the operating requirements for the site to receive recycled water (e.g. demand, storage, pressure requirements, etc.) For each proposal, the Board of Public Utilities must approve it. Should the project connect to the sewer system, the volume of sewage provided to the Laguna WWTP would exceed the required recycled water deliveries during all months. Recycled water would likely be delivered to the Project through the existing facilities. Within the site, some diurnal storage may be required based on the requirements imposed by the City of Santa Rosa. Pumping from the storage to irrigation system pressure may also be required.

### **2.1.3 Wastewater**

This section identifies the expected strength of influent wastewater, describes existing wastewater treatment facilities, and identifies the wastewater treatment options explored for Alternative A. Projected wastewater flows and the proposed wastewater treatment plant (WWTP) process train are also identified.

#### **2.1.3.1 Influent Water Quality**

The quality of influent water for gaming facilities differs from the quality of domestic sewage. This section provides background on the typical quality of influent water at gaming facilities and identifies the facilities required to treat it.

Traditional wastewater treatment options, such as primary clarifiers, activated sludge, conventional filtration, and disinfection, were considered as wastewater treatment plant options. However, typical gaming facility wastes have higher BOD and TSS values compared to domestic wastewater, as identified in Table 2-2.

**Table 2-2: Typical WWTP Influent Water Quality (mg/L)**

Parameter	Alternative A	Typical Domestic Sewage
BOD	450-600	200-300
TSS	450-600	200-300

Shock loadings are also typical of gaming facility wastewater. Weekend flows are much higher than weekday flows, and evening flows are higher than daytime flows. This assumption is based on the higher utilization of similar facilities outside of normal business hours, and the presence of the showroom. The showroom is typically either utilized during the evening and nighttime hours during the week, or during the afternoon and evening on the weekend. Other similar facilities also experience increased utilization of the casino facilities during evenings and on the weekend.

Any wastewater treatment process selected for use must be able to handle the high strength waste and react well to wide variations in flow.

### 2.1.3.2 Capacity

Average weekday and peak weekend flows for Alternative A were obtained from analysis of similar gaming facilities. Table 2-3 summarizes the projections of wastewater volumes generated by Alternative A. These projections are based on the profile of Alternative A identified in the Environmental Impact Statement (EIS).

**Table 2-3: Projected Wastewater Flows for Alternative A**

Area Description	Estimated Occupancy			Factor (%)		Wastewater Flow (gpd)	
	Number	Units	gpd/Unit	Weekday	Weekend	Weekday	Weekend
Casino Gaming and Support Areas	226	KSF	425	80%	100%	77,000	97,000
Buffet	500	Seats	40	80%	100%	16,000	20,000
Coffee Shop	225	Seats	40	80%	100%	8,000	9,000
Food Court	210	Seats	40	80%	100%	7,000	9,000
Leased Restaurants	680	Seats	60	80%	100%	33,000	41,000
Nightclub	6.5	KSF	500	50%	100%	2,000	4,000
Bars (7)	350	Seats	35	80%	100%	10,000	13,000
Lounges (2)	400	Seats	35	80%	100%	12,000	14,000
Event Center	1,500	Seats	35	0%	100%	0	53,000
Banquet Room	1,000	Seats	30	0%	100%	0	30,000
Spa	20	KSF	750	66%	100%	10,000	15,000
Pool Concessions	50	Seats	35	50%	100%	1,000	2,000
Pool Grill	50	Seats	40	50%	100%	1,000	2,000
Hotel	300	Rooms	150	90%	100%	41,000	45,000
<b>Total Wastewater Generated</b>						<b>218,000</b>	<b>354,000</b>

**Notes:**

Gaming area flows include flows associated with patrons use of casino slot machines, tables, high limit slots, asian games, and the employees required to serve these patrons.



gpd = gallons per day  
 KSF = 1000 ft<sup>2</sup>

All flow values were rounded to the nearest 1000 gpd.

Based on the wastewater generation rates identified in **Table 2-3**, any wastewater treatment facility must have the capability to treat and/or convey the project's maximum weekend demand of approximately 354,000 gpd. Based on this weekend capacity, **Table 2-4** identifies the proposed design flows for the WWTP. The design flows are higher than the projected flows in order to provide a safety factor for design to account for the typical diurnal variation. Additional storage will also be provided for equalization of the peak daily flows. The required volume of equalization is expected to be around 80,000 gallons, with a 15% factor of safety. Additional details on the volume of equalization and calculations can be found in **Appendix C**.

**Table 2-4: WWTP Design Flows for Alternative A**

Parameter	Projected Wastewater Flow (gpd)	Design Flow (gpd)
Average Weekday Flow	218,000	250,000
Average Weekend Flow	354,000	400,000

gpd = gallons per day

The wastewater treatment facilities for Alternative A must be designed with a wastewater treatment capacity of 400,000 gpd.

#### 2.1.4 Treatment

Currently there are no wastewater treatment facilities located on the Wilfred site. The Project would need to either convey wastewater to an off-site wastewater treatment plant, or construct a new wastewater treatment facility on-site. These options are further discussed below.

##### 2.1.4.1 Laguna WWTP Connection

The Alternative A site is located within the Laguna Subregional Wastewater Treatment Plant (Laguna WWTP) service area. The Laguna WWTP has a 21.34 MGD daily average dry weather capacity and provides wastewater treatment to the cities of Rohnert Park, Cotati, Santa Rosa, and Sebastopol, as well as the unincorporated South Park County Sanitation District and wastewater from industrial dischargers.

To further analyze the water quality, treatment capacity, and conveyance impacts of the proposed project, the type and nature of the proposed flows was evaluated.

**Water Quality:** The projected water quality of raw sewage from the Project was estimated in Section 2.1.3.1. Twelve months of Laguna WWTP influent water quality was collected from the on-line LIMS water quality database maintained by the City of Santa Rosa on their website (<http://ci.santa-rosa.ca.us/default.aspx?pageID=802>). The two projected water quality parameters, Biochemical Oxygen Demand (BOD) and Total Suspended Solids (TSS) in the Project raw sewage were compared to the existing Laguna WWTP influent water quality to determine the net difference in those concentrations. A table showing the net impact of those parameters is included as **Table 2-5**.

**Table 2-5: Analysis of Laguna WWTP Influent Water Quality with Raw Sewage from the Project**

Month	Average Daily Flow (MGD)	Influent (mg/L)	
		BOD	TSS
Nov-04	17.86	343	465
Dec-04	24.09	378	406
Jan-05	27.88	230	385
Feb-05	23.79	346	527
Mar-05	28.68	280	399
Apr-05	22.92	328	450
May-05	24.38	290	439
Jun-05	19.76	319	399
Jul-05	18.15	334	471
Aug-05	17.62	341	504
Sep-05	17.34	329	501
Oct-05	16.60	455	443
<b>Average</b>	<b>21.59</b>	<b>331</b>	<b>449</b>
Projected raw sewage from Project	0.26	525	525
Net flows with Project and Laguna WWTP	21.85	333	450
<b>Net Difference (%)</b>	<b>1.19%</b>	<b>0.69%</b>	<b>0.20%</b>

Notes:

1. All flows are monthly averages for Laguna WWTP influent.
2. Projected on-site raw sewage water quality based on projections from Section 2.1.2.1.
3. On-site WWTP flows and sewage water quality based on average projections in cited in this report.
4. Source: <http://ci.santa-rosa.ca.us/default.aspx?pageID=802>, November 2005 data through November 7, 2005 only

Sewage from the Project is expected to slightly increase the concentration of BOD and TSS in the Laguna WWTP influent. However, this should have no impact on both the ability of the Laguna WWTP to treat sewage, or the water quality of treatment plant effluent. This is primarily due to the small volume of sewage from the Project compared to all of the other flows to the Laguna WWTP.

**Capacity:** For treatment of sanitary sewage, the City currently owns 3.43 MGD of capacity at the Laguna WWTP, and has authorization from the City of Santa Rosa to use a portion of their unused allotment. Currently this amounts to approximately 0.48 MGD (Parsons, 2004).

If no improvements to the Laguna WWTP are made, the current capacity of 21.34 MGD is expected to allow the member cities to continue to grow until around 2010 at which time the system would no longer be able to accommodate any growth. The projected flow at buildout for the development anticipated in the various cities general plan's is expected to be 25.9 MGD. In order to accommodate this flow, the Santa Rosa Subregional Water Reclamation System's Incremental Recycled Water Program is intended to increase the Laguna WWTP's capacity to meet this demand. These improvements will increase the City's allocation of the Laguna WWTP treatment capacity to 5.15 MGD, the expected flow at buildout (City of Santa Rosa, 2003).

The City recently prepared the Northwest Specific Plan, which documented projected sewage flows for buildout of this area. The Northwest Specific Plan was divided into a northern and

southern area; the southern portion partially overlaps the Wilfred site. This area to the south of Wilfred Avenue covers approximately 101 acres with planned development as follows:

- 39 acres as high density residential
- 50 acres as commercial
- 2 acres as park land
- 10 acres to be either residential or industrial

The Project will leave approximately 35 of the 50 acres of intended commercial area for future development. The Northwest Specific Plan did not document sewage generation rates for this area, but in order to estimate the flows from this area of overlap, HSe estimated the daily volume of sewage generation based on typical master planning estimates for local sewage agencies. Additionally, the 10 acres that was identified for either residential or industrial was treated as residential due to the real estate trends forecast in the Northwest Specific Plan Market Analysis (Economic and Planning Systems Inc, 2004). Assuming that the Project replaces the original Northwest Specific Plan developments in the area of overlap, the estimated flow associated with that replaced area is summarized in Table 2-6.

**Table 2-6: Projected Northwest Specific Plan Sewage Flows in Project Area Only**

Land Use <sup>1</sup>	Number	Unit	Unit Flow Factor <sup>3</sup> (gpd/unit)	Flow
High Density Residential	495	DU	192.8	95,000
Commercial	151 <sup>2</sup>	Ksf	155	23,000
<b>Total</b>				<b>118,000</b>

Notes:

1. Land uses are based on the Northwest Specific Plan buildout program as depicted in Table 4-7 of that document. These values were derived from the plan presented in that document as opposed to the City of Rohnert Park General Plan.
2. The amount of commercial building area is derived from the fact that only about 15.3 out of the 50 acres of Commercial development presented in Table 4-7 of the Northwest Specific Plan will overlap with the Wilfred Site. The projected building area was scaled down from 495 ksf assuming uniform distribution of building area over the entire 50 acres.
3. Unit flow factors are based on the high density unit flow factors from the Northwest Specific Plan, and estimates of unit flow factors for the other types of developments.

The average daily weekday wastewater generated by the Project is higher than the average daily wastewater generated in the Northwest Specific Plan within the Project area by about 100,000 gpd. The average daily weekend wastewater generated by the Project is higher by about 239,000 gpd.

Currently the Laguna WWTP has sufficient capacity to treat and dispose of the project flows. Whether these additional flows are within the City's current treatment capacity allocation at the Laguna WWTP is unclear. The full development of the City's current general plan (through 2020) requires the implementation of the City of Santa Rosa's Improvement Master Plan Long Term Improvements. In order to accommodate the added flows from the project in addition to the buildout flows, the intended capacity of the Laguna WWTP in the year 2020 may have to be increased slightly, as well as the City's allocation of those flows.

**Conveyance:** Connecting to the Laguna WWTP can occur via three options: connecting to the City of Rohnert Park gravity sewer system, connecting to the City's new force main, or constructing a force main to the Laguna WWTP from the Project. Each option is discussed below.

The first option would be to connect into the proposed gravity sewer system conceptualized in the Northwest Specific Plan. Plans for this gravity system show a portion of the flows for the Wilfred site draining to existing sanitary sewers on Redwood Drive, with the remainder flowing into new sanitary sewers. The major gravity sewer conveying sanitary sewage near the Wilfred site is located on Redwood Drive, which is approximately 1200 feet east of the eastern Project boundary. This sewer conveys sanitary sewage to the Rohnert Park Effluent Pump Station (RPEPS), which is shown in **Figure 2-2**. This pump station conveys sewage from Rohnert Park to the Laguna WWTP. The RPEPS would pump sanitary sewage from the Project and its drainage area through a new 30-inch sewer force main and the existing 24-inch force main to the Laguna WWTP, which is located approximately two miles away. The alignment of this force main bisects the Wilfred site, and borders the northern site perimeter on Wilfred Avenue. A map showing the alignment for this force main is shown in **Figure 2-2**.

The City has estimated the available capacity of this trunk sewer to be between 650 and 1800 gpm, depending on the location (Jenkins, 2005). Near Business Park Drive and Redwood Drive, the available capacity is approximately 700 gpm. The average daily flow from this Project is approximately 180 gpm. Peak diurnal flows from the Project are expected to approach 500 gpm. Thus, there is currently available capacity on an average daily basis to convey flow from the Project within this trunk sewer. However, this trunk sewer must convey flows from a number of potential developments in Rohnert Park, including the Northeast, University District, Canon Manor, Southeast, and the Agilent properties. Even without the flows from the Project, there is not sufficient capacity for the additional expected buildout flows of nearly 1200 gpm. Without the Project, it is expected that approximately 1000 to 3000 feet of 15-inch sewer will need to be increased in size to 18-inches. If this gravity sewer conveys both the buildout and Project flows, the upsizing of this pipeline should be designed to accommodate all of the additional flows.

The alignments to convey sewage from the Project to the trunk sewer will be determined during the design phase. Should diurnal variations in capacity within the trunk sewer be identified, flexibility can be designed into the Project to deliver sewage to the trunk sewer during low-flow periods, maximizing the available capacity in the trunk sewer. Methods to provide flexibility would include storing sewage on-site and pumping it into the trunk sewer during low flow periods.

A second option would be to pump sanitary sewage directly into the sewer force main, bypassing the gravity collection system and existing effluent pump station. Sanitary sewage from this force main is conveyed to the Laguna WWTP for treatment, similar to the first option. Preliminary discussions with the City of Rohnert Park have indicated that tapping into the new force main with another force main from the Project would not be permitted (Jenkins, 2005). However this method for connecting the Project to the collection system is technically feasible.

The third option would be to construct a new sewer pump station and force main to convey sewage directly to the Laguna WWTP. This would result in the construction of an on-site pump station and parallel force main from the Project to the Laguna WWTP. This method of





construction is technically feasible, but requires significant political, jurisdictional, and permitting restrictions that may make this alternative not feasible in a timely manner.

Should the Project sewage be conveyed to the Laguna WWTP, coordination with the City would occur to ensure that the operation of the sewage infrastructure meets the needs of both the City and the Project.

Though capacity may be available for conveyance of sanitary sewage to the City and treatment of the sanitary sewage at the Laguna WWTP, the conditions of their approval would need to be discussed in detail with the City of Rohnert Park (conveyance) and the City of Santa Rosa (treatment). These conditions may be subject to political, environmental, or other external factors. An agreement would also need to be negotiated to ensure that the Project has reliable long-term sewer service, as the existing treatment capacity is shared amongst many entities.

**Recycled water:** Should sewage treatment be provided by the Laguna WWTP, it would be desired to have recycled water irrigate landscaping on the Wilfred site. This recycled water would be supplied by the City of Santa Rosa's recycled water distribution system. The City of Santa Rosa has an existing recycled water distribution pipeline on the east bank of the Bellevue-Wilfred Flood Control Channel, as well as on Wilfred Avenue. These pipelines bisect and are on the site frontage.

#### 2.1.4.2 On-Site Wastewater Treatment Facilities

This option would require the construction of an on-site WWTP to provide primary, secondary, and tertiary treatment of on-site sewage for both reuse on-site and discharge off-site. The most likely location for an on-site WWTP would be in the southeast corner of the property, outside of the 100-year flood plain. However, there are significant space limitations within the Wilfred site that require any wastewater treatment process to provide high quality effluent on a small footprint.

A proposed on-site WWTP treatment process for Alternative A would include:

- Influent Pump Station
- Headworks
- Equalization
- Immersed Membrane Bioreactors (MBRs)
- UV Disinfection & Chlorination
- Sludge Stabilization Basins
- Belt Filter Press
- Plant Drain and Supernatant Return Pump Station
- Effluent Pump Station, and
- Operations Building

This treatment process was selected for various reasons, including: 1) the desire for a small footprint for an on-site WWTP, 2) minimize impact to on-site wetlands, 3) the proven effectiveness of this process at other similar facilities, and 4) the production of high quality effluent. The justification for selection of the MBR treatment process is summarized below. A proposed location for the Alternative A wastewater facilities is shown in **Figure 2-1**.

MBRs have successfully treated wastewater for similar-sized gaming facilities with NPDES permits at other local gaming facility sites. The MBR treatment process is a tertiary treatment process similar to an activated sludge treatment plant, but with membranes immersed in an aeration basin. A typical MBR system consists of an anoxic tank for denitrification of the plant influent, followed by an aeration tank for oxidation of organic matter and nitrification. Membrane cartridges are suspended at the effluent end of the aeration tank. The membranes have a pore size in the sub-micron range, and are able to filter out most of the coliform bacteria and solids. Water is drawn through the membranes by blowers, which pull a slight vacuum and force this permeate into the center of the spaghetti-strand shaped membranes. Solids are left in the aeration tank for recirculation to the anoxic zone and/or wasting to solids handling process(es).

Effluent from these types of MBR plants typically contain no suspended solids and have a turbidity of less than 0.2 NTU. This treatment typically results in producing MBR effluent of excellent quality. The MBR process also provides aeration, nitrification, and denitrification processes within a compressed footprint. These processes have the effect of producing effluent with a neutral pH, lower nitrogen concentrations, and lower phosphorous concentrations than alternative tertiary treatment processes.

The MBR treatment process is capable of producing effluent meeting the Title 22 coliform bacteria effluent requirements without the use of chlorine or other common disinfectants. Other tertiary treatment systems typically require a disinfection process to meet the effluent coliform requirement. However, in order to comply with treatment and water reuse regulations, both a UV disinfection and chlorine disinfection processes will be provided downstream of the MBR processes.

Although the MBR treatment process is somewhat sophisticated, it is relatively simple to operate and maintain due to the absence of traditional WWTP components such as clarifier mechanisms or drives. In addition, there is a long history of effectiveness at similar facilities.

**Operation:** Wastewater will flow by gravity from the Wilfred site through a grease interceptor, and then into an influent pump station. The influent pump station will lift the wastewater to the plant headworks facilities. After passing through the headworks, wastewater will flow by gravity to the influent distribution channel. The distribution channel will be used to distribute wastewater to the parallel MBR trains. Each train will be equipped with an anoxic basin and an aeration basin to provide oxidation, nitrification, and denitrification. Water will flow out of the aeration basin and into a membrane chamber that will be shared by both process trains. Permeate will be extracted through the membranes, and conveyed to either the UV disinfection or chlorine disinfection processes. Water intended for reuse on-site for Title 22 purposes will be chlorinated with sodium hypochlorite. Water intended for discharge to the Laguna de Santa Rosa will be UV disinfected. The proposed wastewater flow diagram is shown in **Figure 2-3**.

#### 2.1.4.3 Wastewater Treatment Summary

If a suitable agreement to connect the Project's sewage to the City's gravity sewer collection system could be obtained, and that sewage could be treated at the Laguna WWTP, that would be the preferred method for wastewater treatment. The Project would construct sewage pipelines in accordance with those planned for the Northwest Specific Plan, and Project

Legend  
 Treated Water  
 Waste Stream

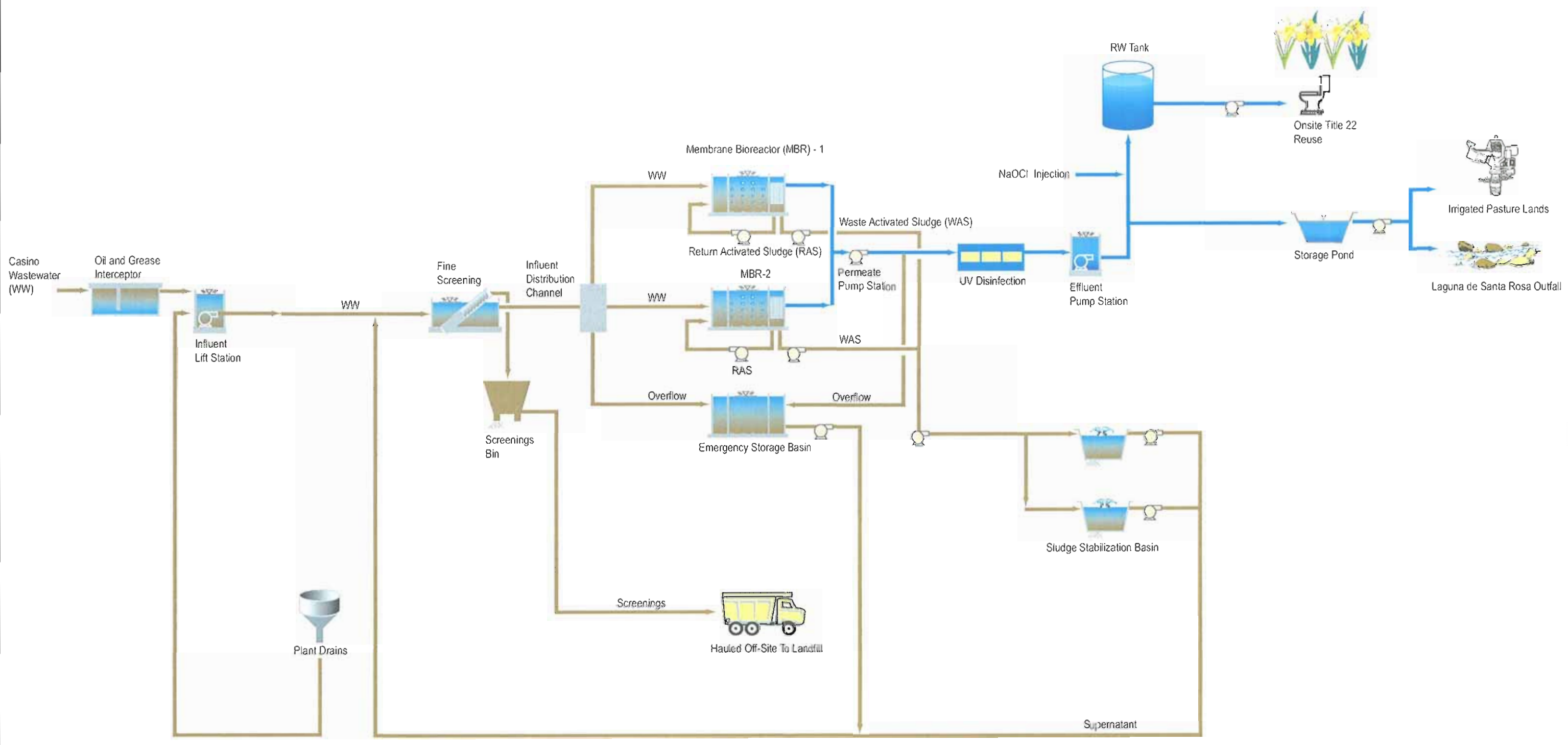

s:\ccr\m\projects\Station Casinos\Robnet Park\Figures\Figure 1-2 Flow Diagram.a



**FIGURE 2-3**  
 STATION CASINOS  
 GRATON RANCHERIA HOTEL AND CASINO PROJECT  
 WASTEWATER TREATMENT PROCESS FLOW DIAGRAM

wastewater would be conveyed to the Laguna WWTP for treatment. However, this agreement may place significant conditions on the Project, which are not currently known. Additionally, this agreement would be subject to additional environmental review, political considerations, and public review and comment. In the absence of an existing agreement, the preferred method for treating the Project's wastewater would be to construct an on-site WWTP. Therefore, further evaluation of treatment at the Laguna WWTP was not further considered in this report.

An on-site WWTP would allow for the treatment and use of sewage generated, limit external influences over facility operation, allow for tertiary effluent to be reused on-site in accordance with Title 22 requirements, and ensure that high quality effluent is discharged to the Laguna. In addition, the proposed on-site WWTP would be well suited to handle shock loadings, would have the capacity available for Alternative A, and would not require modifications to off-site sanitary sewer facilities.

### 2.1.5 Effluent Disposal

The on-site WWTP will treat wastewater to a tertiary level and allow the Project to consider a wide range of effluent disposal options. Tertiary treatment is typically defined as a process that has undergone primary treatment consisting of a gravity settling process, secondary treatment consisting of a biological process, and tertiary treatment consisting of both a filtration and a disinfection process. These treatment processes can be combined into one process spanning the different types of treatment.

In order to evaluate other wastewater disposal strategies, the following assumptions were made:

- Recycled water use on-site will be maximized.
- The Project must identify a reliable wet season disposal method.
- The Project must comply with all applicable regulatory requirements.

**Permitting Requirements:** The permitting requirements for a new on-site WWTP will depend largely upon:

1. Whether the wastewater treatment plant and effluent disposal system are located on Federal trust land or Sonoma County land, and
2. Whether the wastewater treatment plant is permitted for discharge to surface waters or if all effluent disposal must occur on-site.

If the on-site WWTP discharges to surface waters, regardless if it is on trust land or off trust land, a National Pollution Discharge Elimination System (NPDES) permit will be required for discharge to waters of the United States. If the wastewater treatment plant and effluent disposal system can be designed to eliminate surface water discharges, then the permitting process can be much simpler. If any of the wastewater were disposed of on County land then a Waste Discharge Requirements (WDR) permit would have to be issued by the Regional Water Quality Control Board (RWQCB). If the wastewater disposal system can be contained on trust land, then no formal public review or discharge permit from the RWQCB is required. Should this occur, the United States Environmental Protection Agency (USEPA) would review the project to assure compliance with very similar discharge criteria to those anticipated for the RWQCB.

The USEPA and Indian Health Services (IHS) regulates the use of recycled water on trust lands. The regulatory requirements for recycled water use are further outlined in Section 4.2. The reader is referred to that section for further information.

The following four potential methods of wastewater discharge are further discussed in this section:

- Seasonal Storage Ponds/Spray Fields
- Subsurface Discharge
- Surface Water Discharge
- Seasonal Surface Water Discharge

The beneficial uses of the potential receiving waters will also be identified because these uses must be maintained and protected from potential pollutants.

#### 2.1.5.1 Seasonal Storage Ponds/Spray Fields

The seasonal storage ponds would be used to store tertiary effluent from the WWTP until it can be used to irrigate the spray fields at agronomic rates. Typically, water would be stored in the seasonal storage ponds during the dry season, and applied to the spray fields at agronomic rates year-round. The regulatory requirements for the operation of seasonal storage ponds are typically minor, and the primary consideration is the disposition of the effluent contained therein. The ponds would need to be lined with a relatively impermeable material such as clay or concrete to minimize percolation into the groundwater. It is also suggested that any seasonal storage ponds be located downgradient from any proposed water supply well used for the Project and outside of the 100-year flood plain. There is expected to be sufficient area for all ponds to be sited outside of the 100-year floodplain. If any pond were to be located within the 100-year floodplain, it would need to be bermed with adequate freeboard to bring the pond high water level above of the 100-year flood level.

Seasonal storage ponds would be significantly upsized if it were determined that the Project either could not or is limited in its ability to discharge wastewater effluent off-site. **Table 2-7** summarizes conceptual estimates of the seasonal storage requirements and spray field area requirements for two effluent disposal strategies for Alternative A. One strategy assumes that the Project will be able to dispose of effluent to the Laguna during the wet season via the Bellevue-Wilfred Channel. The second effluent disposal strategy assumes that effluent can only be disposed of on spray fields during the dry season, and stored in seasonal storage reservoirs during the wet season for future irrigation on the spray fields at agronomic rates. These estimates are preliminary and are for planning purposes only. The Alternative A storage pond and spray field areas for the wet season discharge and wet season storage are shown in **Figures 2-1** and **2-4** respectively. Portions of the areas identified for spray fields are within the 100-year flood zone. This, however, is not expected to be an issue, during periods of rain, effluent is normally stored in the seasonal storage pond.



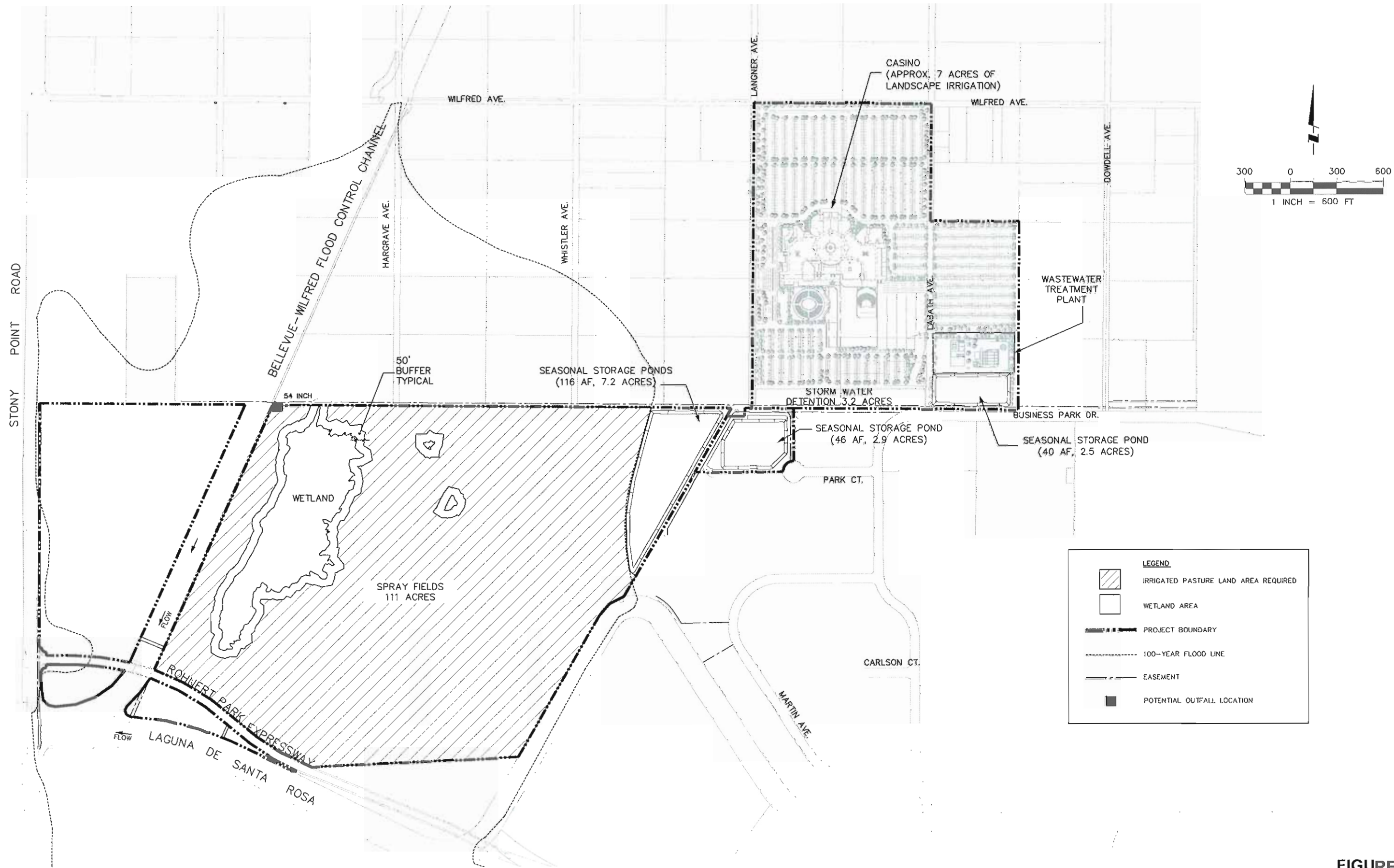

**FIGURE 2-4**  
**STATION CASINOS**  
**GRATON RANCHERIA HOTEL AND CASINO PROJECT**  
**ALTERNATIVE A - WET SEASON STORAGE**

**Table 2-7: Estimated On-Site Seasonal Disposal Requirements**

Seasonal Disposal Strategy	Seasonal Storage Requirement (AF)	Spray Field Area <sup>c</sup> (Acres)
Wet Season Storage <sup>a</sup>	202	111 <sup>d</sup>
Wet Season Discharge <sup>b</sup>	25	54

AF = acre-feet

Notes:

a: This disposal strategy assumes that all effluent will be disposed to spray fields from April to October and stored in a reservoir or wetlands during the rest of the year

b: This disposal strategy assumes that all effluent will be disposed to spray fields from April to October and that all water produced during the wet season will be disposed of to the Bellevue-Wilfred Channel. A minimal amount of seasonal storage is still assumed for operational control.

c: Spray field acreage may consist of irrigated landscape in addition to dedicated spray fields.

d: An additional 7 acres of landscape irrigation would be utilized for this alternative for a total disposal area of 118 acres.

### 2.1.5.2 Spray Field and Storage Sizing Criteria

The primary criteria used to determine the required spray field acreage are evapotranspiration (ET) rates and precipitation information. Water demands per acre of irrigated area are calculated for each month based on evapotranspiration (ET) rates and precipitation records with an additional factor to account for a very wet year. This monthly demand is then used to calculate an annual disposal capacity per acre in such a wet year. Previous studies have estimated standard evapotranspiration rates and rainfall for the area.

**ET Rates:** ET is a measure of water usage by a particular plant or crop, and is a function of the net solar radiation, air temperature, wind speed, and vapor pressure in a particular location. Evapotranspiration rates for a specific crop in a specific location are calculated on a monthly basis by the following equation:

$$ET = ET_o * k_c$$

where:

ET<sub>o</sub> = Normal year reference crop evapotranspiration rate for a given geographic location (California Department of Water Resources (DWR), California Irrigation Management Information System (CIMIS) database)

k<sub>c</sub> = Crop coefficient for a given crop (DWR Leaflets)

For this Plan, reference crop normal year evapotranspiration rates (ET<sub>o</sub>) for the CIMIS station closest to the area were obtained from the DWR CIMIS database. Crop coefficients for cool weather turf grasses were obtained from University of California, Division of Agriculture and Natural Resources Leaflet 21427. Calculated ET rates and irrigation demands are shown in **Table 2-8**.

**Precipitation:** Precipitation data was also obtained from the CIMIS station closest the area using the DWR CIMIS database. Monthly rainfall values from 1990 through the present were averaged to obtain typical monthly rainfall data.



**Estimated Unit Irrigation Demands:** Typical monthly unit irrigation demands for turf grasses are summarized in Table 2-8 and were calculated using the following formula:

$$ID = \frac{(ET - Pe_p)l_r}{e_i}$$

where:

- ID = Irrigation demand in inches
- ET = Evapotranspiration for turf grasses
- P = Average precipitation, DWR
- e<sub>p</sub> = Precipitation irrigation efficiency, 0.75. Assumes 75% of rainfall during growing season is lost to evaporation, runoff, etc.
- l<sub>r</sub> = Loss Rate, equal to 1.1. This assumes that approximately 10% of the applied water passes through the grass root zone and is lost.
- e<sub>i</sub> = Irrigation efficiency, varies throughout the year between 0.60 in the summer and 0.95 in the winter. This assumes that 5-40% of the applied irrigation water is lost to the environment.

**Table 2-8: Typical Irrigation Demands for Regional Turf Grasses**

Month	ET (Inches)	P (Inches)	ID (Inches)	ID (Feet)
January	1.21	3.89	0.00	0.00
February	0.81	6.40	0.00	0.00
March	0.82	7.19	0.00	0.00
April	1.29	6.57	3.31	0.28
May	2.50	4.15	5.97	0.50
June	3.49	2.04	7.17	0.60
July	4.44	1.58	8.71	0.73
August	5.01	1.46	7.66	0.64
September	5.17	0.56	3.00	0.25
October	4.74	0.75	1.20	0.10
November	3.60	0.36	0.00	0.00
December	2.60	1.56	0.00	0.00
<b>Average</b>			<b>3.1</b>	<b>0.26</b>
<b>Total</b>	<b>35.66</b>	<b>36.49</b>	<b>37.0</b>	<b>3.09</b>

As shown, above, in Table 2-8, the total annual unit irrigation demand for grasses is estimated at 37.0 inches or 3.09 feet.

**Sizing:** Spray fields are sized such that the annual capacity is sufficient to dispose of the wastewater flows. Precipitation and evaporation into and out of the seasonal storage reservoirs with a safety factor to account for the annual rainfall event with a 100-year return interval is also included in the sizing of the spray fields. Seasonal storage ponds are sized to hold all discharge and precipitation during the winter months when there is no irrigation demand. These ponds are

subsequently emptied during the summer months before the next wet season. Detailed sizing calculations can be found in **Appendix B**.

#### **2.1.5.3 Subsurface Discharge**

Subsurface discharge typically consists of constructing an underground leach field for plant effluent to percolate into the subsurface within the Wilfred site. A WDR permit issued by the RWQCB would be required for subsurface effluent disposal in leach fields off-site from trust lands. The USEPA regulates on-site subsurface discharge. Subsurface disposal permitting would likely be based on groundwater quality degradation criteria regulated by the USEPA. Successful permitting of subsurface disposal discharge may require a hydrogeological study to establish pollutant transport patterns in the nearest identifiable groundwater basin. An analysis may also be required to determine the downgradient environmental impacts to other beneficial users of the groundwater basin. The primary beneficial users of groundwater are humans who use the groundwater for potable water.

The potential for installation of leach lines in Sonoma County is extremely limited because less than 1% of the total County area is reported to have soil characteristics suitable for the placement of leach fields. Less than 10% of the County is reported to have soil conditions that may be acceptable for leach fields, but on-site tests are typically required to determine if this is the case. The remaining land mass of Sonoma County is underlain by soils that are unacceptable for the satisfactory placement of leach lines due to inadequate percolation rates, steepness of slope, depth to rock, or depth to water.

Preliminary soil surveys of the proposed Wilfred site suggest the presence of fat clayey soils that extend to a typical depth of approximately 20 feet near the Wilfred site. These types of soils typically do not percolate well. The County has indicated that local residential leach fields with similar soil characteristics typically do not percolate well. In addition to good percolation, leach fields typically require a minimum of several feet clearance above the highest groundwater levels. Shallow perched groundwater aquifers typically occur in the Wilfred site area and would make it highly unlikely that deep leach fields could be constructed below the clay soil fields and still be above the groundwater.

This information suggests that the proposed site is not suitable for subsurface effluent disposal.

#### **2.1.5.4 Surface Water Discharge**

For discharge of treated wastewater to the Laguna or its tributaries, a NPDES discharge permit will be required. Any discharge to the Bellevue-Wilfred Channel or the Laguna would be regulated by the RWQCB. The Bellevue-Wilfred Channel is owned by the SCWA and the Laguna is a public water body. It is expected that the discharge water quality requirements would be the same for each, although the flow limitations may vary.

The feasibility of obtaining a NPDES permit for the site was reviewed with the RWQCB (Region 1 –Santa Rosa). The RWQCB stated that there were no moratoriums on surface water discharges in this tributary, and discharges could be permitted as long as they complied with the following criteria:

1. Dry season discharges (May 15 through September 30) cannot be permitted under any circumstances due to a lack of dilution in the receiving water.
2. Wet season discharges (October 1 through May 14) could be permitted, as long there was no more than 1% dilution of the receiving water. The board has discretion with respect to the dilution criteria and the point of compliance. A number of recent local NPDES discharge permits, including those for WWTPs in Santa Rosa and Windsor, utilize the flow at the nearest upstream or downstream USGS flow monitoring gauging station as the basis for establishing flow in the Russian River. This flow is utilized to determine the maximum allowable discharge the actual tributary that plant discharges to. HSe is tracking flows at the nearest USGS gauging stations on the Laguna to determine typical streamflow rates of the potential receiving waters.
3. The initial permit point of the compliance would probably be granted based on conditions at the actual point of discharge. The most likely flow monitoring location would be at the USGS gauging station at the southwest corner of the Wilfred site (USGS #11465680). This is the most practical site to determine flows, since data has been collected for over five years, and real-time data is available. This gauging station is located downstream of the confluence of the Bellevue-Wilfred Channel and the Laguna. Based on flow records obtained from this station, it may be feasible to meet a 1% dilution requirement based on the project makeup and proposed wastewater treatment and disposal facilities if flow data from this station is the basis for the flow limitation in the Project's NPDES permit.
4. Baseline flows and water quality data must be presented with the NPDES permit application for review and consideration. HSe recently completed a baseline monitoring program to analyze the water quality at this location. This baseline monitoring program is collecting surface water quality data at the local gauging station location in order to determine Laguna water quality, and for use as a basis for a potential NPDES permit.

Effluent disposal directly to the Laguna would require a NPDES permit issued through the RWQCB and potentially construction easements across public land. Effluent disposed of to a stream or channel within trust lands would be permitted by the USEPA, not by the RWQCB. The USEPA typically permits projects discharging onto trust lands in a similar manner as the RWQCB, and reviews projects to ensure that they comply with the same criteria typically applied by the RWQCB. Disposal of effluent on-site would also not require construction easements from others.

Thus, the project's site maps were reviewed to identify existing storm drain inlets to both the Laguna and the Bellevue-Wilfred Channel. Discharging effluent to the Laguna would increase effluent dilution and allow flow to be accurately monitored by the existing USGS gauging station. Streamflow rates near the Wilfred site are highest in this location, which maximizes effluent dilution. However, there is no current discharge pipelines at this location, and Rohnert Park expressway would need to be crossed. Both of these issues would require external permitting.

There are storm drains on the east side of the Bellevue-Wilfred Channel that allow flow to enter the channel from the Alternative A site. These storm drains would allow effluent to be discharged within the tribal trust lands, enter the existing storm drain inlet and flow off-site. The preferred storm drain for wastewater discharge would be a 54-inch diameter outfall, which is located approximately 1,900 feet north of the Rohnert Park Expressway. This location is also planned for use as a stormwater outfall. If it is determined during the design stage that there is not sufficient capacity in the 54-inch outfall for both stormwater and wastewater discharges, it

may be necessary to discharge to a different location. A map showing the proposed discharge location is included in **Figure 2-1**.

**2.1.5.5 Seasonal Surface Water Discharge**

Seasonal surface water discharge means the utilization of different effluent disposal options during the dry and wet seasons to address local season-specific regulatory and environmental concerns. The use of different seasonal effluent disposal options is a common practice in the State of California. The disposal locations would be the same as those identified in *Section 2.1.5.4 Surface Water Discharge*, but they would be utilized only during the wet season. The wet season and dry season discharge methods are defined below.

1. **Dry season (May 15 through September 30):** Disposal through a combination of on-site recycled water use for landscape irrigation, cooling towers, and toilet flushing, plus the use of spray fields.
2. **Wet season (October 1 through May 14):** Disposal through a combination of the dry season uses, and surface water discharge.

The RWQCB prohibited effluent discharges from wastewater treatment plants to the Russian River and its tributaries (which includes the Laguna) between May 15 and September 30 in their Basin Plan due to significant seasonal flow variations for the Russian River tributaries during the summer and winter months. Their goal was to ensure that these water bodies do not become effluent dominated streams. Discharges during the wetter winter months (October 1 to May 14) when flows are higher are typically allowed to be a certain percentage of the average daily streamflow. It is likely that any new treatment plant discharge would be subject to similar seasonal discharge requirements. It is not expected that year-round discharges to a tributary of the Russian River would be permitted by the USEPA under any circumstances as the USEPA typically permits projects discharging onto trust lands in a similar manner as the RWQCB. The Basin Plan also limits discharges of wastewater effluent to a percentage of the streamflow at the point of discharge. Since an active USGS gauging station is located near the proposed discharge location, historical streamflows are known. However, the percentage of the total streamflow the USEPA will allow the Project to discharge is unknown.

The monthly streamflow statistics for the USGS gauging station at the southwest corner of the Wilfred site are presented in **Table 2-9**. From this data, it is apparent that discharges immediately before and after the summertime months (May and October) may be limiting for the project, and that streamflow rates are highly variable from year to year. Thus, for any discharge scenario developed for the Project, backup contingency plans should be developed for low flow conditions. **Table 2-9** suggests that at a minimum, discharge of at least 100,000 gpd could be permitted in the Laguna near the Wilfred site during April and November, with more allowed during the months in between.

**Table 2-9: Daily Average Streamflow at USGS Gauging Station #11465680**

Year	Jan	Feb	Mar	Apr	May	Jun	Jul	Aug	Sep	Oct	Nov	Dec
1998	ND	ND	ND	ND	ND	ND	ND	ND	ND	ND	ND	16.30
1999	40	210	74	33	4	1	1	1	1	3	11	2
2000	39	253	76	16	7	1	1	0	0	9	3	4

Year	Jan	Feb	Mar	Apr	May	Jun	Jul	Aug	Sep	Oct	Nov	Dec
2001	33	85	38	5	1	1	1	0	0	1	48	232
2002	127	30	26	6	4	2	1	0	0	0	13	231
2003	69	28	14	36	31	2	1	0	0	0	6	87
2004	59	144	19	5	2	0	0	0	0	ND	ND	ND
<b>Overall Average (cfs)</b>	<b>61</b>	<b>125</b>	<b>41</b>	<b>17</b>	<b>8</b>	<b>1</b>	<b>1</b>	<b>0</b>	<b>0</b>	<b>3</b>	<b>16</b>	<b>95</b>
<b>Overall Average (MGD)</b>	<b>40</b>	<b>81</b>	<b>27</b>	<b>11</b>	<b>5</b>	<b>1</b>	<b>1</b>	<b>0</b>	<b>0</b>	<b>2</b>	<b>10</b>	<b>62</b>
<b>Calculated Daily Flow Values (MGD)</b>												
5% of Overall Average	1.98	4.05	1.33	0.54	0.26	0.04	0.03	0.01	0.01	0.08	0.52	3.09
1% of Overall Average	0.40	0.81	0.27	0.11	0.05	0.01	0.01	0.001	0.001	0.02	0.10	0.62

ND: No Data

Note: ND readings are not counted in calculating average flows.

The RWQCB has verbally suggested that the Project would be able to discharge tertiary effluent at a rate equal to 1% of the flows at the Laguna discharge location during the periods when surface water discharges are permitted. Since it is expected that all effluent produced by the Project will be treated to tertiary standards, a goal of the permit negotiation process will be to obtain a permit allowing discharge as much flow as possible into the Laguna.

#### 2.1.5.6 Beneficial Uses of Potential Receiving Waters

Both year-round and seasonal surface water discharges must comply with the existing beneficial uses of the Laguna and Bellevue-Wilfred Channel. A description of the beneficial uses for these waterways is described below.

The existing and potential beneficial uses assigned to the Laguna by the North Coast RWQCB in the Basin Plan are listed in **Table 2-10**. The beneficial uses are uses as they exist at the present while potential uses are that those uses that may have existed prior to November 1975 or are attainable via future plans, future review might classify the use as an existing use, or are listed as a future water quality goals for possible use.

**Table 2-10: Beneficial Uses for the Laguna de Santa Rosa**

Existing Beneficial Uses		Potential Beneficial Uses	
AGR	Agricultural Supply	AQUA	Aquaculture
COLD	Cold Freshwater Habitat	MUN	Municipal and Domestic Supply
COMM	Commercial or Sport Fishing	POW	Hydropower
FRSH	Freshwater Replenishment	PRO	Industrial Process Supply
GWR	Groundwater Recharge	SHELL	Shellfish Harvesting
IND	Industrial Service Supply		
MIGR	Migration of Aquatic Organisms		
NAV	Navigation		
RARE	Rare, Threatened, or Endangered Species		

Existing Beneficial Uses		Potential Beneficial Uses	
REC1	Water Contact Recreation		
REC2	Non-Water Contact Recreation		
SPWN	Spawning, Reproduction, and/or Early Development		
WARM	Warm Freshwater Habitat		
WILD	Wildlife Habitat		

Source: Basin Plan 2003 Rev. North Coast Region.

Beneficial uses of waters of the United States are uses that must be protected against water quality degradation, and reflect the demands on the water resources for this stream. Water quality objectives for the Laguna are based on the identified beneficial uses. Some of these water quality objectives are summarized in Table 2-11.

**Table 2-11: Water Quality Objectives of Receiving Waters**

Parameter	Description
Color	Water shall be free of coloration that causes a nuisance or adversely affects beneficial uses.
Taste & Odor	Water shall not contain taste or odor producing substances in concentrations that impart undesirable tastes or odors to fish flesh or other edible products of aquatic origin, or that cause nuisance or adversely affect beneficial uses.
Turbidity	Shall not be increased more than 20% above naturally occurring background levels.
PH	Shall not be depressed below 6.5 or raised above 8.5. Changes in normal pH levels shall not exceed 0.5 units in waters with COLD beneficial uses.
Dissolved Oxygen	Minimum of 7.0 mg/l at the compliance point.
Coliform	In waters with REC-1 beneficial uses, the median fecal coliform concentration on a minimum of not less than five samples for any 30-day period shall not exceed 50 per 100 mL, nor shall more than ten percent of the total samples during any 30-day period exceed 400/100 mL.
Temperature	At no time or place shall the temperature of any COLD water be increased by more than five degrees Fahrenheit.
Other Parameters	The following are prohibited in concentrations that cause nuisance to or adversely affect beneficial uses: floating material, suspended material, settleable material, oil and grease, biostimulatory substances.  Discharges containing toxic substances, pesticides, chemical constituents, or radioactivity in concentrations that impact beneficial uses are prohibited.

#### 2.1.5.7 Effluent Disposal Summary

The preferred methods for effluent disposal would include seasonal surface water discharge off-site, maximizing on-site recycled water use, and the use of seasonal storage ponds and spray fields. This combination of alternatives would be structured as follows:

During the winter, effluent from the on-site WWTP would be used on-site for recycled water uses, discharged on-site to a ditch tributary to the Bellevue-Wilfred Channel, stored in on-site seasonal storage ponds, and used to irrigate the spray fields at agronomic rates. The spray fields would be irrigated by pumping effluent out of the seasonal storage pond(s). Effluent stored in the seasonal storage pond would be discharged to the on-site ditch tributary to the Bellevue-Wilfred Channel in accordance with flow limitation requirements.

During the summer months, effluent from the on-site WWTP would be used on-site for recycled water uses, and used to irrigate spray fields. Effluent that could not be used for either purpose would be stored in the seasonal storage ponds.

## **2.2 Alternative B**

The water and wastewater issues associated with Alternative B are largely similar to Alternative A, except that the project would be located at the intersection of Stony Point Road and Wilfred Avenue on the west side of the Bellevue-Wilfred Channel. The trust lands for this alternative total 360 acres, and include an area roughly bordered by Stony Point Road to the west, Wilfred Avenue to the North, Rohnert Park Expressway to the South, and Whistler and Langner Avenues to the east. Additionally, all of the appropriate water and wastewater treatment facilities would be constructed to the west of the Bellevue-Wilfred Channel. Access to the Stony Point site would be from Stony Point Road and Wilfred Avenue. A map of Alternative B is shown in Figure 2-5.

### **2.2.1 Water Supply**

Water supply quality and quantity for Alternative B is expected to be the same as previously described in Alternative A. The reader is referred to that section for additional information.

### **2.2.2 Wastewater**

Wastewater influent water quality, treatment plant capacity, and the methods for wastewater treatment would be the same as previously described in Alternative A. The reader is referred to that section for additional information.

### **2.2.3 Effluent Disposal**

Effluent disposal methods for Alternative B would be similar to Alternative A, except that the location of the spray fields, seasonal storage ponds, and surface water discharge would be modified to take advantage of storm drain inlets on the west side of the Bellevue-Wilfred Channel, and be located within the revised trust boundaries. Like Alternative A, effluent discharge locations would seek to utilize existing storm drain inlets draining to the Bellevue-Wilfred Channel. The beneficial uses for the receiving waters for Alternative B are the same as those described for Alternative A. The reader is referred to that section for additional information about beneficial uses.

Maps showing the Bellevue-Wilfred Channel were studied to determine the most suitable discharge location. An ephemeral stream on the west side of the Bellevue-Wilfred Channel flows through the Stony Point site and into an existing 54-inch storm drain. The existence of this stream makes it ideal for Project flows to be discharged directly into the Bellevue-Wilfred Channel. The proposed discharge location is shown in Figure 2-5.

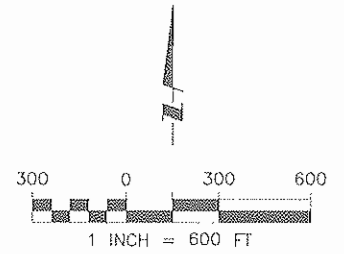
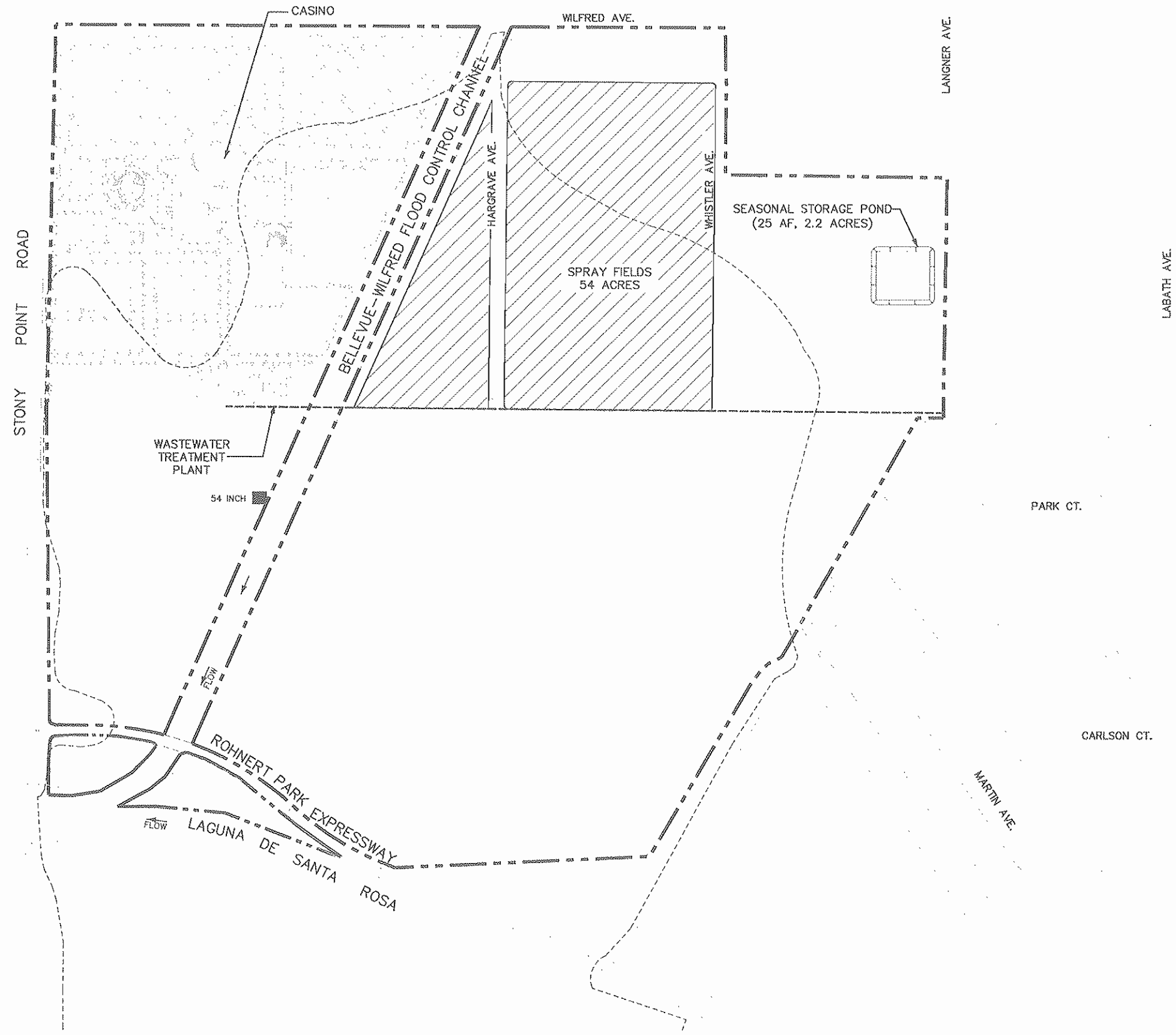

LEGEND	
	IRRIGATED PASTURE LAND AREA REQUIRED
	WETLAND AREA
	PROJECT BOUNDARY
	100-YEAR FLOOD LINE
	POTENTIAL OUTFALL LOCATION

**FIGURE 2-5**  
**STATION CASINOS**  
**GRATON RANCHERIA HOTEL AND CASINO PROJECT**  
**ALTERNATIVE B - WET SEASON DISCHARGE**



Like Alternative A, recycled water use would be maximized on-site for all Title 22 approved uses including landscape irrigation, toilet flushing, and cooling water make-up. A seasonal storage pond and spray fields will be used in conjunction with the permitted discharge periods as described in *Section 2.1.3 Effluent Disposal*. The seasonal storage pond would be designed to provide for wet season discharge and storage of effluent during the summertime. The Alternative B storage pond and spray field areas are the same as those for Alternative A. The wet season discharge and wet season storage scenarios for Alternative B are shown in **Figures 2-5 and 2-6** respectively, and are summarized in **Table 2-7**.

## **2.3 Alternative C**

The water and wastewater issues associated with Alternative C are largely similar to Alternatives A and B, except that the project would be located closer to the Bellevue-Wilfred Channel while remaining on the east side. Additionally, the trust boundaries for Alternative C are the same as those described for Alternative B. Access to the Stony Point site would be from Wilfred Avenue and Whistler Avenue. A map of Alternative C is shown in **Figure 2-7**.

### **2.3.1 Water Supply**

Water supply quality and quantity for Alternative C is expected to be the same as previously described in Alternative A. The reader is referred to that section for additional information.

### **2.3.2 Wastewater**

Wastewater influent water quality, treatment plant capacity, and the methods for wastewater treatment would be the same as previously described in Alternative A. The reader is referred to that section for additional information.

### **2.3.3 Effluent Disposal**

Effluent disposal methods for Alternative C would slightly differ from Alternative A.

There are multiple storm drains on the east side of the Bellevue-Wilfred Channel that allow flow to enter the Channel from the Alternative C site. These storm drains would allow effluent to be discharged within the tribal trust lands, enter the existing storm drain inlet, then flow off-site. The preferred storm drain outfalls would be located near the confluence of the Bellevue-Wilfred Channel with the Laguna, and have a larger diameter to accommodate peak flows. Of the available outfall locations, the preferred discharge location is a 54-inch storm drain outfall approximately 1900 feet north of Rohnert Park Expressway. This location will also likely be utilized as a stormwater outfall as described in Alternative A. The reader is referred to that section for additional information. The proposed discharge location is shown in **Figure 2-8**.

The beneficial uses for the receiving waters and the preferred discharge location for Alternative C are the same as those described for Alternative A. The reader is referred to that section for additional information.

Like Alternative A, recycled water use would be maximized on-site for all Title 22 approved uses including landscape irrigation, toilet flushing, and cooling water make-up. A seasonal storage pond and spray fields will be used in conjunction with the permitted discharge periods as described in *Section 2.1.3 Effluent Disposal*. The seasonal storage pond would be designed to provide for wet season discharge and storage of effluent during the summertime. The Alternative C storage pond and spray field areas are the same as those for Alternative A. The wet season discharge and wet season storage scenarios for Alternative C are shown in **Figures 2-7** and **2-8** respectively, and are summarized in **Table 2-7**.

## 2.4 Alternative D

Alternative D would be a smaller version of the gaming and entertainment facility described in Alternatives A, B and C, and located on the west side of the Bellevue-Wilfred Channel. Alternative D has a project footprint of 413,400 square-feet, including a casino with slot machines, gaming tables, multiple restaurants and bars, banquet rooms, a 100-room hotel and spa, and 4,650 on-site parking spaces. The appropriate scale of the on-site water and wastewater facilities would be of smaller magnitude as well. The trust boundaries for Alternative D are the same as Alternatives A, B, and C. The casino would be accessed via Stony Point Road and Wilfred Avenue. The water and wastewater treatment facilities would be located to the southeast of the gaming facility adjacent to the Bellevue-Wilfred Channel. A map showing the location of Alternative D is shown in **Figure 2-9**.

### 2.4.1 Water Supply

The water supply options for Alternative D is expected to be the same as previously described in Alternative A.. However, the projected water demand for Alternative D is expected to be lower, as shown in **Table 2-12**. The average water demand is projected to be around 115 gpm. Peak water demands, which typically occur during the weekends, are projected to be approximately 145 gpm. Water supply requirements and average water demand are based on similar principles as identified in the description for Alternative A. The reader is referred to that section for additional information.

**Table 2-12: Projected Water Supply Requirements for Alternative D**

Water Supply Requirement without Recycled Water (gpm)	Water Supply Requirement with Recycled Water (gpm)	Minimum Recommended Firm Water Supply (gpm)
150	125	150

gpm = gallons per minute

### 2.4.2 Wastewater

The wastewater quality projected for Alternatives A, B and C would also apply to Alternative D. Thus, the same methods of wastewater treatment would be utilized.

Alternative D has reduced wastewater flows when compared to Alternatives A, B and C due to the reduced scope of the Project facilities. The projected wastewater flows for Alternative D are identified in **Table 2-13**.









**Table 2-13: Projected Wastewater Flows for Alternative D**

Area Description	Estimated Occupancy			Factor (%)		Wastewater Flow (gpd)	
	Number	Units	gpd/Unit	Weekday	Weekend	Weekday	Weekend
Casino Gaming and Support Areas	196	KSF	425	80%	100%	67,000	84,000
Buffet	500	Seats	40	80%	100%	16,000	20,000
Coffee Shop	225	Seats	40	80%	100%	8,000	9,000
Food Court	210	Seats	40	80%	100%	7,000	9,000
Leased Restaurants	480	Seats	60	80%	100%	24,000	29,000
Nightclub	0	KSF	500	50%	100%	0	0
Bars (7)	350	Seats	35	80%	100%	10,000	13,000
Lounges (2)	400	Seats	35	80%	100%	12,000	14,000
Event Center	0	Seats	35	0%	100%	0	0
Banquet Room	1000	Seats	30	0%	100%	0	30,000
Spa	0	KSF	750	66%	100%	0	0
Pool Concessions	50	Seats	35	50%	100%	1,000	2,000
Pool Grill	50	Seats	40	50%	100%	1,000	2,000
Hotel	100	Rooms	150	90%	100%	14,000	15,000
<b>Total Wastewater Generated</b>						<b>160,000</b>	<b>227,000</b>

**Notes:**

Gaming area flows include flows associated with patrons use of casino slot machines, tables, high limit slots, asian games, and the employees required to serve these patrons.

gpd = gallons per day

KSF = 1000 ft<sup>2</sup>

All flow values were rounded to the nearest 1000 gpd.

**Table 2-14** summarizes the proposed design flows for an on-site WWTP designed to treat flows from Alternative D. Similar to the design flows for Alternatives A, B and C, the design flows for Alternative D are slightly higher than the projected weekend wastewater flows in order to provide a safety factor for design to account for typical diurnal variation. Additional storage will also be provided for equalization of the peak daily flows. The required volume of equalization is expected to be around 45,000 gallons, with a 15% factor of safety. Additional details on the volume of equalization and calculations can be found in **Appendix C**.

**Table 2-14: Projected Design Flows for Alternative D**

Parameter	Projected Wastewater Flow (gpd)	Design Flow (gpd)
Average Weekday Flow	160,000	200,000
Average Weekend Flow	227,000	275,000

gpd = gallons per day

The wastewater treatment facilities for Alternative D must be designed for a dry weather flow capacity of 275,000 gpd. The design flows are slightly higher than the projected wastewater flows in order to provide a safety factor for design and to accommodate unforeseen changes in the project.

### 2.4.3 Effluent Disposal

The methods of effluent disposal for Alternative D are the same as for Alternative B. Since the seasonal surface water discharges are similar, the beneficial uses of the receiving waters are also the same. One difference between Alternative D and Alternative B is the required volume for the seasonal storage ponds and area of spray fields required. Additionally, Alternative D would utilize the wastewater outfall location outlined in Alternative B on the west side of the Bellevue-Wilfred Channel.

Based on the expected wastewater flows from the Project, seasonal storage ponds and spray fields were sized. The seasonal storage pond volumes and spray field areas are summarized in **Table 2-15**.

**Table 2-15: Seasonal Disposal Strategy for Alternative D**

Seasonal Disposal Strategy	Seasonal Storage Requirement (AF)	Spray Field Area <sup>c</sup> (Acres)
Wet Season Storage <sup>a</sup>	148	83
Wet Season Discharge <sup>b</sup>	18	37

AF = acre-feet

Notes:

a: This disposal strategy assumes that all effluent will be disposed to spray fields from April to October and stored in a reservoir or wetlands during the rest of the year.

b: This disposal strategy assumes that all effluent will be disposed to spray fields from April to October and that all water produced during the wet season will be disposed of to the Bellevue-Wilfred Channel. A minimal amount of seasonal storage is still assumed for operational control.

c: Spray field acreage may consist of irrigated landscape.

The wet season discharge and wet season storage scenarios for Alternative D are shown in **Figures 2-9** and **2-10** respectively.

## 2.5 Alternative E

Alternative E would be a business park located to the west of the Bellevue-Wilfred Channel, at the same location as Alternative B. The business park would be approximately 500,000 square-feet with 3,500 on-site parking spaces. The appropriate water and wastewater treatment facilities would be located to the south of the business park facilities, as shown in **Figure 2-11**.



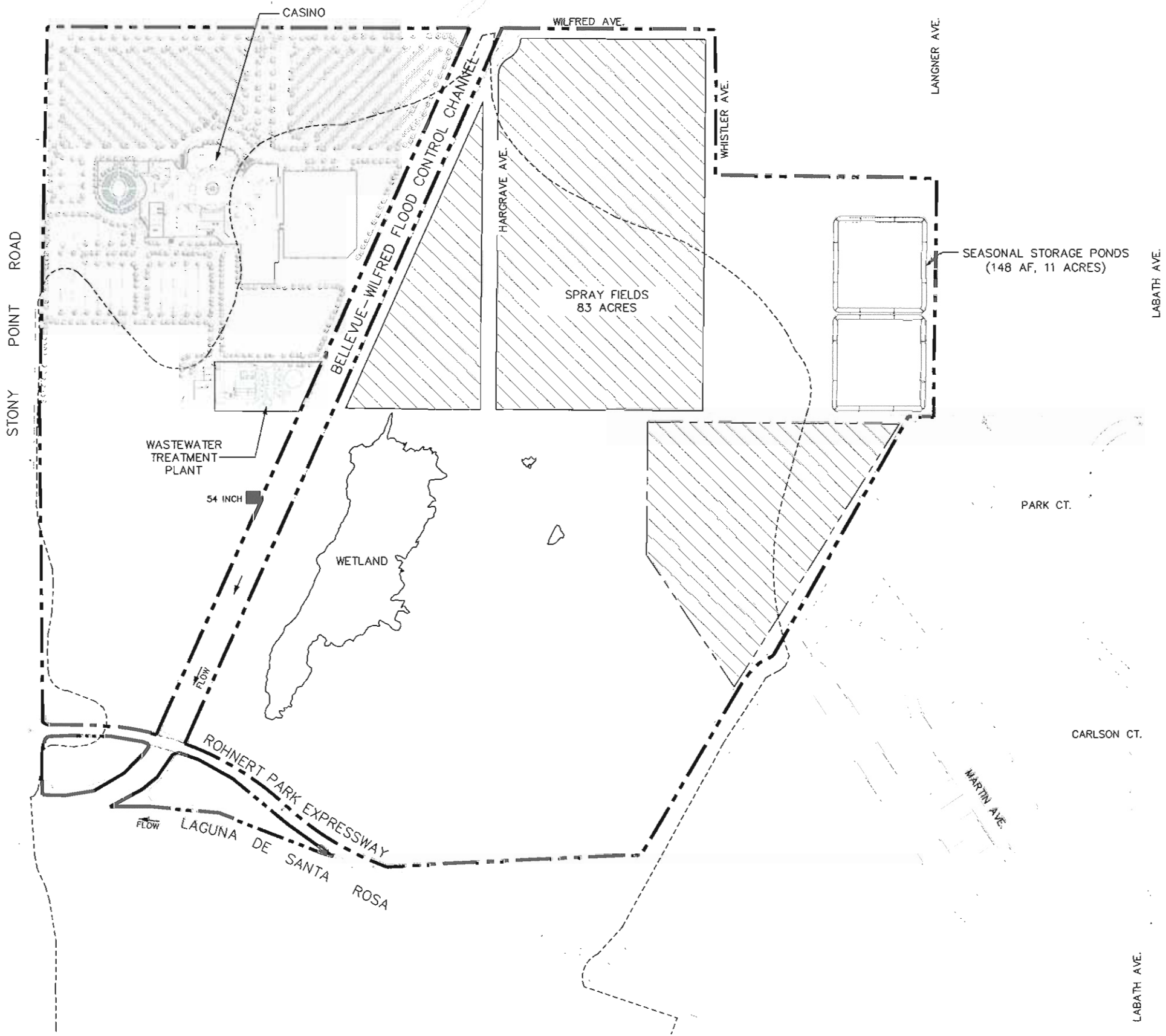

### 2.5.1 Water Supply

The water supply for Alternative E would be from on-site wells. The projected water supply requirements for Alternative E are summarized in **Table 2-16**. The average water demand is projected to be 43 gpm. Peak water demands, which would generally occur during weekdays, are projected to be approximately 50 gpm. Water supply requirements and average water demand are based on similar principles as identified in the description for Alternative A. The reader is referred to that section for additional information.





**LEGEND**

-  IRRIGATED PASTURE LAND AREA REQUIRED
-  WETLAND AREA
-  PROJECT BOUNDARY
-  100-YEAR FLOOD LINE
-  POTENTIAL OUTFALL LOCATION

**FIGURE 2-10**  
**STATION CASINOS**  
**GRATON RANCHERIA HOTEL AND CASINO PROJECT**  
**ALTERNATIVE D - WET SEASON STORAGE**

S:\Common\Projects\19\_00\_Station\_Casinos\Station\_Casinos\_Planet\_Permit\Final\Report\Sheet\Casino 2-10.dwg DATE: 11/27/08



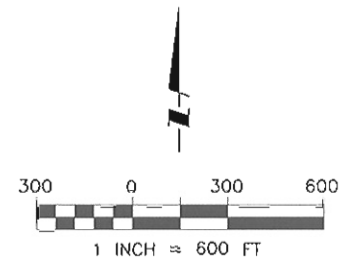
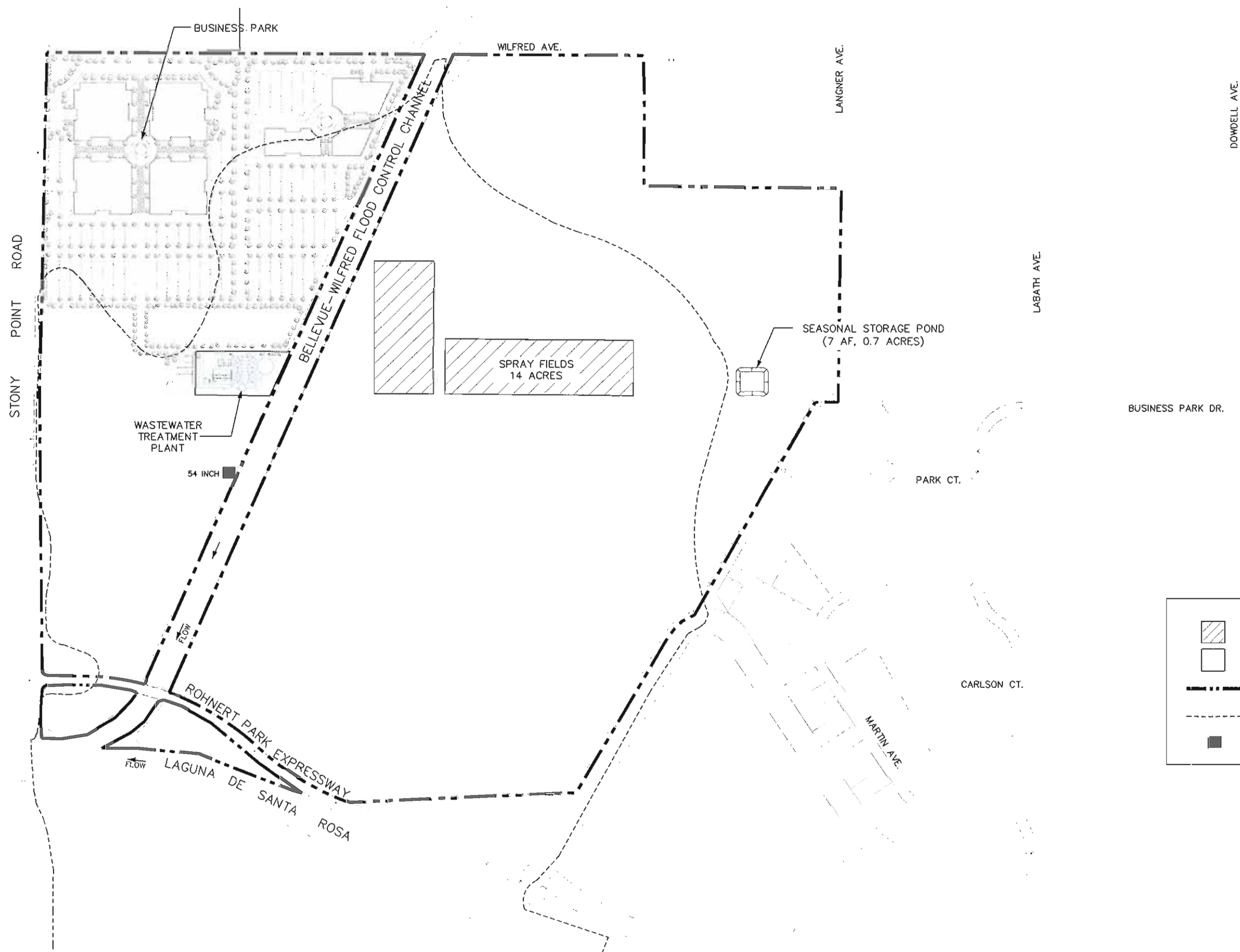

LEGEND	
	IRRIGATED PASTURE LAND AREA REQUIRED
	WETLAND AREA
	PROJECT BOUNDARY
	100-YEAR FLOOD LINE
	POTENTIAL OUTFALL LOCATION

**FIGURE 2-11**  
**STATION CASINOS**  
**GRATON RANCHERIA HOTEL AND CASINO PROJECT**  
**ALTERNATIVE E - WET SEASON DISCHARGE**

S:\Graton\Project\Map\Map\_05\Station\_Casinos\_Plan\Station\_Casinos\_Plan.dwg, 2-11.dwg, DATE: 11/27/06

**Table 2-16: Projected Water Supply Requirements for Alternative E**

Water Supply Requirement without Recycled Water (gpm)	Water Supply Requirement with Recycled Water (gpm)	Minimum Recommended Firm Water Supply (gpm)
65	50	65

gpm = gallons per minute

## 2.5.2 Wastewater

This section identifies the expected strength of influent wastewater, describes existing wastewater treatment facilities, and identifies the wastewater treatment options explored for Alternative E. Projected wastewater flows and the proposed WWTP's process train are also identified.

### 2.5.2.1 Influent Water Quality

The wastewater quality for Alternative E is expected to be similar to typical domestic sewage. While Alternatives A, B, C and D are expected to have a higher strength influent due to the nature of the Project facilities, Alternative E contains facilities that are very common to any wastewater treatment facility collection area. Thus, the expected influent water quality would be as described in **Table 2-17**.

**Table 2-17: Projected WWTP Influent Water Quality – Alternative E (mg/L)**

Parameter	Alternative E
BOD	200-300
TSS	200-300

### 2.5.2.2 Capacity

Average weekday and peak weekend flows for Alternative E were obtained from analysis of similar business park type facilities. The projected flows for Alternative E are summarized in **Table 2-18**. These projections are based on the profile of the Alternative identified in the EIS.

**Table 2-18: Projected Wastewater Flows for Alternative E**

Area Description	Estimated Occupancy			Factor (%)		Wastewater Flow (gpd)	
	Number	Units	gpd/Unit	Weekday	Weekend	Weekday	Weekend
Light Industrial Business	400	KSF	155	100%	50%	62,000	31,000
Commercial Business	100	KSF	155	100%	50%	16,000	8,000
<b>Total Wastewater Generated</b>						<b>78,000</b>	<b>39,000</b>

Notes:

Gaming area flows include flows associated with patrons use of casino slot machines, tables, high limit slots, asian games, and the employees required to serve these patrons.

gpd = gallons per day

KSF = 1000 ft<sup>2</sup>

All flow values were rounded to the nearest 1000 gpd.

**Table 2-19** summarizes the Alternative E design flows for the WWTP. The design flows are slightly higher than the projected wastewater flows in order to provide a safety factor for design, and to accommodate unforeseen changes in the project. Additional storage will also be provided for equalization of the peak daily flows. Based on an assumed diurnal curve for mixed commercial and industrial development, the required volume of equalization is expected to be around 20,000 gallons, with a 15% factor of safety. Additional details on the volume of equalization and calculations can be found in **Appendix C**.

**Table 2-19: Design Flows for Alternative E**

Parameter	Projected Wastewater Flow (gpd)	Design Flow (gpd)
Average Weekday Flow	78,000	90,000
Peak Weekend Flow	39,000	45,000

gpd = gallons per day

The on-site WWTP for Alternative E would have a wastewater treatment capacity of 90,000 gpd.

### 2.5.2.3 Treatment

Like the previous alternatives, on-site treatment facilities would also be desirable for Alternative E. Although Alternative E is a business park, the benefit of having an on-site MBR WWTP would allow the Project to control their own wastewater treatment facilities, and maximize the use of their recycled water on-site for landscape irrigation and toilet flushing. As such, Title 22 regulations would still need to be met, therefore, requiring a WWTP capable of producing high quality effluent. Additional reasons for having an MBR plant are:

- Small footprint and option to house the plant to match existing architecture;
- Ease of operation – MBR plants are for the most part automated;
- MBRs are typically less susceptible to upsets when compared to conventional plants;
- MBRs typically require less chemical addition and so require less chemical storage capacity; and
- MBRs have the ability to maintain consistency in effluent quality.

### 2.5.3 Effluent Disposal

The methods of effluent disposal for Alternative E are the same as for Alternative A. Since the seasonal surface water discharges are similar, the beneficial uses of the receiving waters are also the same. One difference between Alternative E and Alternative A is the required volume for the seasonal storage ponds and area of spray fields required. Additionally, Alternative E would utilize the discharge location outlined in Alternative B on the west side of the Bellevue-Wilfred Channel.

Based on the expected wastewater flows from the Project, seasonal storage ponds and spray fields were sized. The seasonal storage pond volumes and spray fields areas are summarized in **Table 2-20**.

**Table 2-20: Seasonal Disposal Strategy for Alternative E**

Seasonal Disposal Strategy	Seasonal Storage Requirement (AF)	Spray Field Area <sup>c</sup> (Acres)
Wet Season Storage <sup>a</sup>	57	31
Wet Season Discharge <sup>b</sup>	7	14

Notes:

a: This disposal strategy assumes that all effluent will be disposed to spray fields from April to October and stored in a reservoir or wetlands during the rest of the year.

b: This disposal strategy assumes that all effluent will be disposed to spray fields from April to October and that all water produced during the wet season will be disposed of to the Bellevue-Wilfred Channel. A minimal amount of seasonal storage is still assumed for operational control.

c: Spray field acreage may consist of irrigated landscape.

AF = acre-feet

The wet season discharge and wet season storage scenarios for Alternative E are shown in **Figures 2-11** and **2-12** respectively.

## 2.6 Alternative F

Alternative F would be a gaming and entertainment casino identical to Alternative A in magnitude and facilities. Alternative F was conceived to be the same project as Alternative A, but in a different location. The reader is referred to the Alternative A description for details regarding casino size and facilities.

The Lakeville site for Alternative F is made up of three separate areas, two to the east of Lakeville Highway and one to the west. The majority of the Project facilities would be located on the parcel to the west side of the Highway. The areas are within the County of Sonoma, north of Highway 37, west of the Infineon Raceway, and east of the Petaluma River. The entrances to the casino would be from Lakeville Highway. The location of this project is shown in Figure 2-13.

### 2.6.1 Water Supply

Like Alternative A, the water supply for Alternative F would be from on-site wells. The projected water demands for Alternative F are the same as those projected for Alternative A and are summarized in **Table 2-1**. The reader is referred to *Section 2.1.1 Water Supply* for additional information regarding water demands.

It is believed that groundwater is available within the Lakeville site. A well was drilled near the southwest corner of the site during 2003, and has satisfactory flows and generally good water quality. This well would be one of the two groundwater wells used by the Project to meet their firm water supply requirements.

### 2.6.2 Wastewater

The influent water quality, projected wastewater flows, and design flows for Alternative F are exactly as those described for Alternative A. The reader is referred to that section for more

details. The options for wastewater treatment are different for Alternative F, as discussed below.

### 2.6.2.1 Treatment

There are no existing wastewater treatment facilities at the Lakeville site. Constructing a new on-site WWTP or connecting to an existing plant would be the two options available for Alternative F. This section describes these options in more detail.

The nearest wastewater treatment facility to the Alternative F site is the Novato Sanitary District plant (NSD). The NSD plant has a 4.53 MGD average dry weather capacity, and is located approximately six miles west of the Lakeville site within the City of Novato. However, the NSD service area does not extend to the Lakeville site. As such, Alternative F would likely not be able to obtain sewer service from NSD without modifying the NSD service area or negotiating an agreement to treat Project sewage. Furthermore, there are no wastewater lines extending to the Lakeville site making it possible for the project to connect to, and thus obtain sewer service. Another nearby plant is the City of Petaluma WWTP, which is located approximately ten miles north of the Lakeville site. However, the City of Petaluma WWTP has similar issues regarding the ability to treat Project wastewater as the NSD plant.

Therefore, like Alternative A, it would be preferable for Alternative F to construct on-site WWTP facilities. The on-site WWTP facilities for Alternative F would be the same in size and capacity as those for Alternative A. They would be located at the location identified in **Figure 2-13**.

The reader is referred to *Section 2.1.2.3 Treatment* for details regarding the type of process and operation of an on-site WWTP.

### 2.6.3 Effluent Disposal

The effluent disposal options for Alternative F would be the same as those discussed for Alternative A. As such, the same assumptions made for Alternative A were made for Alternative F:

- Recycled water use on-site will be maximized.
- The Project must identify a reliable wet season disposal method.
- The Project must comply with all applicable regulatory requirements.

The permitting requirements and four potential discharge methods below are the same for both Alternatives A and E. The reader is referred to *Section 2.1.3 Effluent Disposal* for additional information regarding permitting requirements.



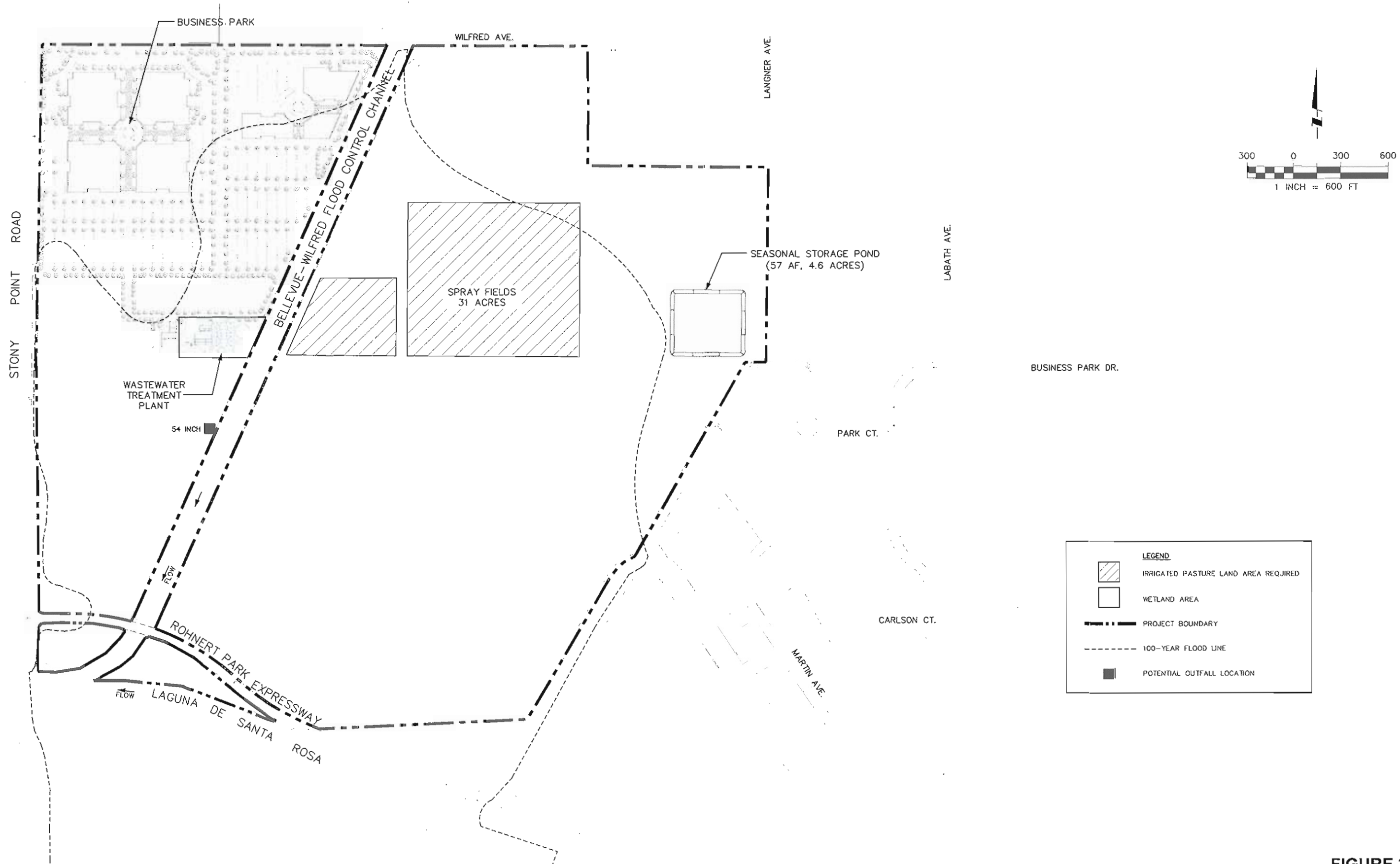

- Seasonal Storage Ponds/Spray Fields
- Subsurface Discharge
- Surface Water Discharge
- Seasonal Surface Water Discharge

The beneficial uses of the potential receiving waters, the Petaluma River, will also be identified given that these uses must be protected from potential pollutants.





**LEGEND**

-  IRRIGATED PASTURE LAND AREA REQUIRED
-  WETLAND AREA
-  PROJECT BOUNDARY
-  100-YEAR FLOOD LINE
-  POTENTIAL OUTFALL LOCATION

**FIGURE 2-12**  
**STATION CASINOS**  
**GRATON RANCHERIA HOTEL AND CASINO PROJECT**  
**ALTERNATIVE E - WET SEASON STORAGE**

C:\Users\jw\Documents\Projects\Station\_Casinos\_Schematic\Station\_Casinos\_Schematic.dwg 2-12.dwg 3/11/12 2:08



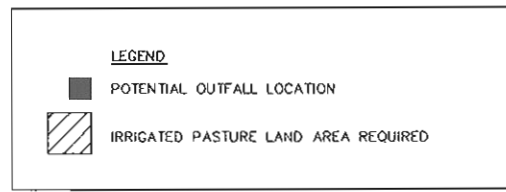
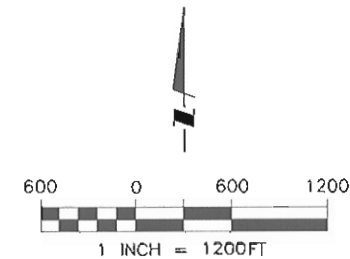
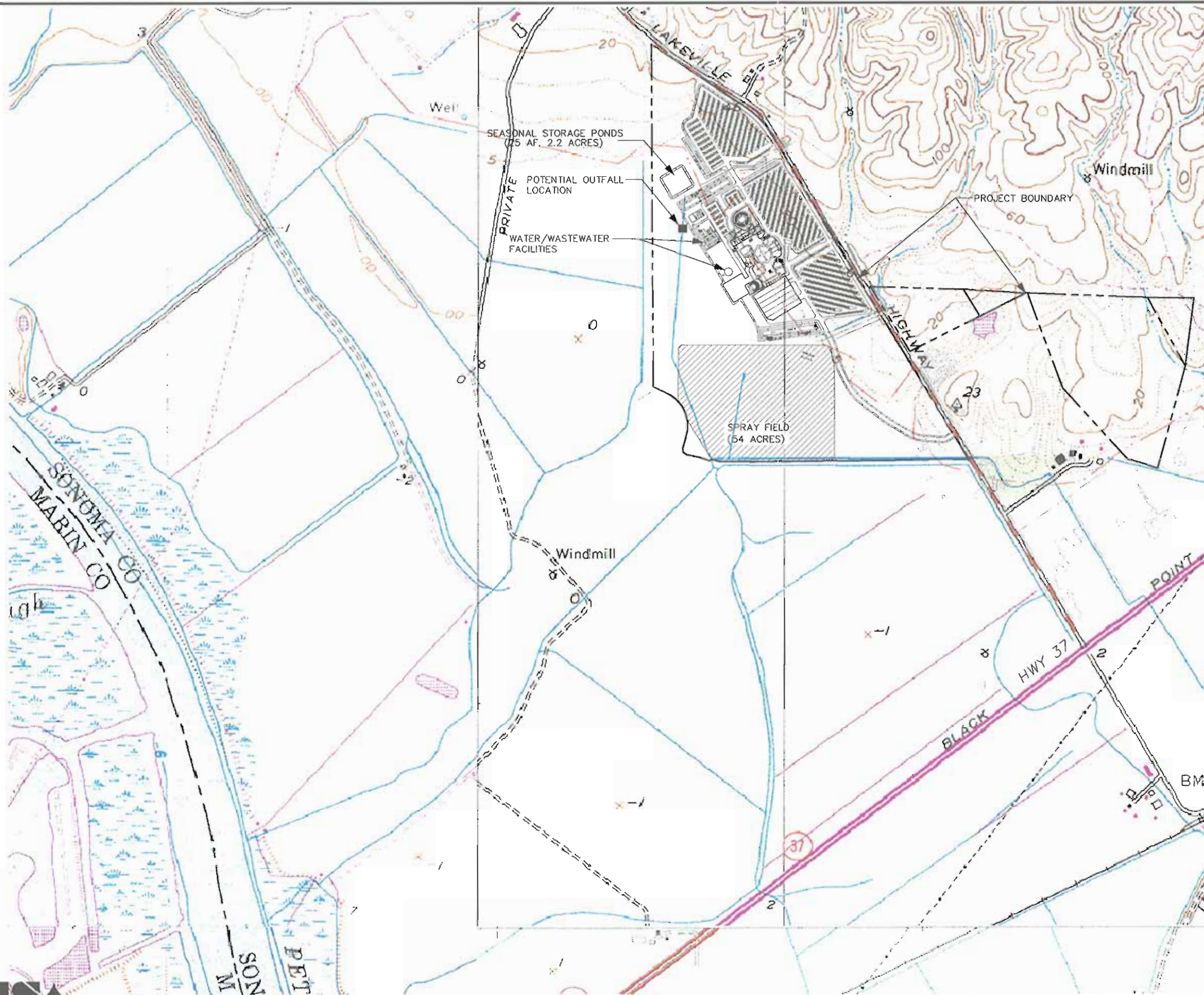

**FIGURE 2-13**  
**STATION CASINOS**  
**GRATON RANCHERIA HOTEL AND CASINO PROJECT**  
**ALTERNATIVE F - WET SEASON DISCHARGE**

S:\Common\Projects\191\_201\_Sonoma\_Casino\_Rancheria\_Plan\Responsibility\_Report\Report\Drawings\2-13.dwg 04/11/2005

### 2.6.3.1 Seasonal Storage Ponds/Spray Fields

The seasonal storage pond volumes, and spray fields areas are summarized in **Table 2-21**. The reader should note that the seasonal storage pond areas in **Table 2-21** are the same as those specified for Alternative A.

**Table 2-21: Seasonal Disposal Strategy for Alternative F**

Seasonal Disposal Strategy	Seasonal Storage Requirement (AF)	Spray Field Area <sup>c</sup> (Acres)
Wet Season Storage <sup>a</sup>	202	111 <sup>d</sup>
Wet Season Discharge <sup>b</sup>	25	54

Notes:

a: This disposal strategy assumes that all effluent will be disposed to spray fields from April to October and stored in a reservoir or wetlands during the rest of the year.

b: This disposal strategy assumes that all effluent will be disposed to spray fields from April to October and that all water produced during the wet season will be disposed of to the Bellevue-Wilfred Channel. A minimal amount of seasonal storage is still assumed for operational control.

c: Spray field acreage may consist of irrigated landscape.

d: An additional 7 acres of landscape irrigation would be utilized for this alternative for a total disposal area of 118 acres.

AF = acre-feet

The wet season discharge and wet season storage scenarios for Alternative F are shown in **Figures 2-13** and **2-14** respectively.

The limits of the Lakeville site contain enough land to locate both of the wet season discharge and wet season storage scenarios. For the wet season discharge alternative, the storage ponds and the spray fields would be contained on the largest area to the west of Lakeville Highway. For the wet season storage alternative, 111 acres of spray fields and 202 AF of seasonal storage ponds require the use of two areas. The seasonal storage ponds would be located on the larger parcel to the west of Lakeville Highway. A portion of the spray fields would be located on the east of Lakeville Highway with the remaining portion of the spray fields on the larger area to the west of the Highway.

### 2.6.3.2 Subsurface Discharge

Subsurface discharge, as stated in *Section 2.1.5.3 Subsurface Discharge*, requires that soil conditions allow sufficient percolation for the installation of leach fields. Furthermore, preliminary site observations indicate that the top layer of soil is made up of soft bay mud approximately 50 – 60 feet in depth. Bay mud also does not percolate well. Thus, it is not expected that using leach fields as the primary discharge method is feasible, and the option for subsurface discharge is therefore eliminated.

The regulatory issues discussed in *Section 2.1.5.3 Subsurface Discharge*, for Alternative A regarding the permitting of subsurface discharge are the same for Alternative F. The reader is referred to that section for additional details.



### 2.6.3.3 Surface Water Discharge

The option to dispose of effluent to surface waters via an existing, unnamed stream on the Lakeville site was evaluated. A mapped stream on the Lakeville site is a tributary of the Petaluma River. The disposal of treated effluent would take place via a stream within proposed trust lands to the south of the on-site WWTP. From that point the stream flows south, then southwest where it enters into the Petaluma River. The location of the stream within the Lakeville site is shown in **Figure 2-13**.

The discharge of tertiary treated effluent to the Petaluma River and its tributaries would also require an NPDES permit. Although the feasibility of obtaining an NPDES permit was not reviewed with the RWQCB, it is anticipated that the following criteria would apply to surface water discharges:

1. Dry season discharges cannot be permitted under any circumstances due to a lack of dilution in the receiving water.
2. The initial permit point of the compliance would probably be granted based on conditions at the actual point of discharge.
3. Baseline flows and water quality data must be presented with the NPDES permit application for review and consideration.

Additional information regarding discharge to the on-site stream would still need to be obtained given that the stream flows through several properties prior to reaching the Petaluma River. This feasibility study does not, however, include additional information regarding additional implications of the surface water discharge via this stream.

### 2.6.3.4 Seasonal Surface Water Discharge

It is anticipated that the seasonal surface water discharge strategy for Alternative F would be the same as the one specified for Alternative A with the exception of the disposal location, the receiving waters, and dry and wet season dates. The following describes the wet and dry seasons accordingly:

1. **Dry season (June 1 through August 31):** Disposal through a combination of on-site recycled water use for landscape irrigation, cooling towers, and toilet flushing, plus the use of spray fields.
2. **Wet season (September 1 through May 31):** Disposal through a combination of the dry season uses, and surface water discharge.

The closest WWTP to the Lakeville site is NSD. NSD is permitted to discharge treated wastewater to the San Pablo Bay during the wet season. It is anticipated that the disposal period would be the same for the Project, given that the Petaluma River is a tributary of the San Pablo Bay.

### 2.6.3.5 Beneficial Uses of Potential Receiving Waters

The beneficial uses of the Petaluma River listed in the RWQCB Region 2 Basin Plan for the San Francisco Bay are summarized in **Table 2-22**.

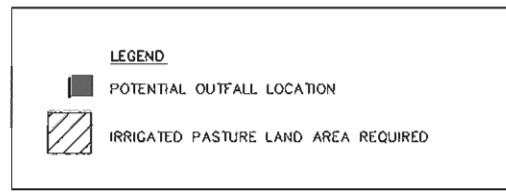
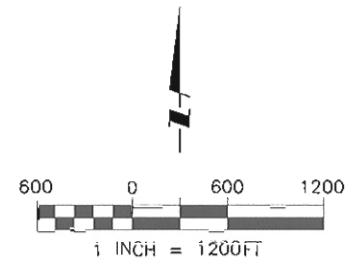
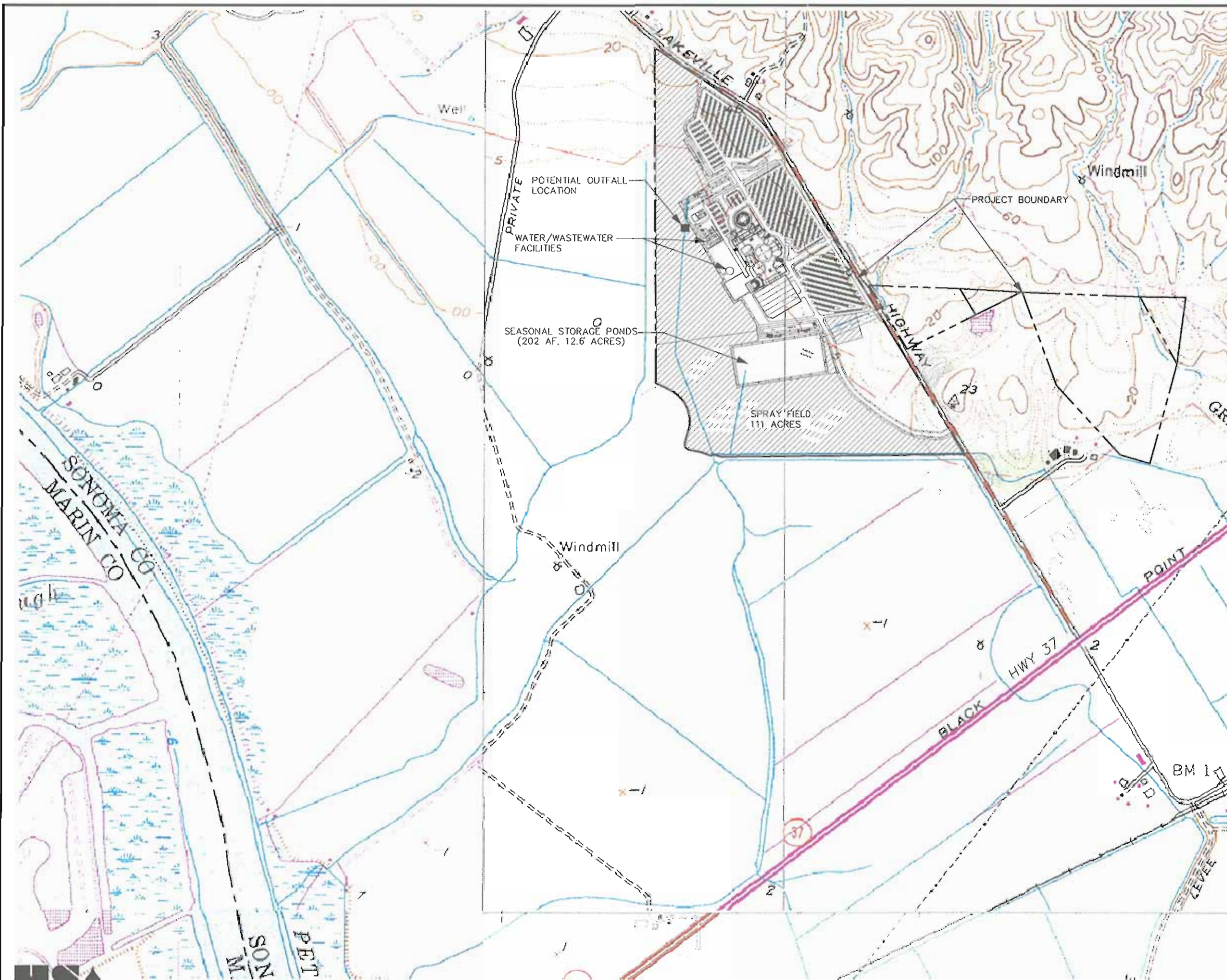

**FIGURE 2-14**  
**STATION CASINOS**  
**GRATON RANCHERIA HOTEL AND CASINO PROJECT**  
**ALTERNATIVE F - WET SEASON STORAGE**



**Table 2-22: Beneficial Uses for the Petaluma River**

Acronym	Description
COLD	Cold Freshwater Habitat
MAR	Marine Habitat
MIGR	Fish Migration
NAV	Navigation
RARE	Preservation of Rare and Endangered Species
REC1	Water Contact Recreation
REC2	Non-contact Water Recreation
SPWN	Fish Spawning
WARM	Warm Freshwater Habitat
WILD	Wildlife Habitat

Source: San Francisco Bay Basin Plan

In addition, the Basin Plan specifies specific water quality objectives for all water bodies in order to prevent the degradation of any existing water body. Some of these objectives are summarized in **Table 2-23**.

**Table 2-23: Water Quality Objectives of Receiving Waters**

Parameter	Description
Color	Water shall be free of coloration that causes a nuisance or adversely affects beneficial uses.
Taste & Odor	Water shall not contain taste or odor producing substances in concentrations that impart undesirable tastes or odors to fish flesh or other edible products of aquatic origin, or that cause nuisance or adversely affect beneficial uses.
Turbidity	Shall not be greater than 10% in areas where natural turbidity is greater than 50 NTU.
pH	Shall not be depressed below 6.5 or raised above 8.5. Changes shall not cause the pH to be above 0.5 units in normal ambient pH levels.
Dissolved Oxygen	Minimum of 5.0 mg/l at the compliance point.
Oil and Grease	Water shall not contain oils, or greases, waxes, or other material, including solids, liquids, foams, and scum in concentrations that cause a nuisance or adversely affect beneficial uses.
Temperature	The temperature of any cold or warm freshwater habitat shall not increase more than 5°F above naturally receiving water temperature.
Floating Material	Waters shall not contain floating material, including solids, and scum, in concentrations that cause a nuisance or adversely affect beneficial uses.
Other Parameters	All waters shall be maintained free of toxic substances in concentrations that are lethal to or that produce significant alterations in population or community ecology or receiving water biota.

### 2.6.4 Effluent Disposal Summary

The preferred methods for effluent disposal would be as described for Alternative A in *Section 2.1.3.6 Effluent Disposal Summary*, with the exception that surface discharge would go to the Petaluma River and effluent discharge would be prohibited from June 1 to August 31. The reader is therefore referred to that section for more detailed information. It is expected that the primary effluent disposal site will be to an on-site stream that is tributary to the Petaluma River. In addition, the Project size is not such that all of the required spray fields and seasonal storage

ponds can be located within the Project boundaries. Provisions would have to be made to accommodate for this on-site discharge.

Additional information and research regarding discharge to the Petaluma River is still required. However, this report will not provide additional details regarding discharge to the river in question.

## **2.7 Alternative G**

Alternative G is a no action alternative under which no project facilities of any type would be constructed. Instead of any project facilities, it was assumed that the Northwest Specific Plan, prepared by the City of Rohnert Park, would be constructed in accordance with the parameters listed in that document. It was also assumed that all potable water, sewage, and recycled water would be managed in the manner identified in that document.

As discussed previously in Section 2.1.3.1, the Northwest Specific Plan partly overlaps a portion of the Wilfred site. In evaluating Alternative G, only that portion of the Northwest Specific Plan that overlaps with the Wilfred Site was examined.

### **2.7.1 Water Supply**

In the Northwest Specific Plan, it was assumed that the water supply for the portion of the Plan south of Wilfred Avenue would be provided from existing sources. This includes the entire area of overlap between the Northwest Specific Plan Area and the Wilfred site. It was indicated in the report that the City of Rohnert Park currently has adequate water supply to serve this area. This conclusion was based on the assumption that both the municipal supply wells, one of which is located in the area on the south side of Business Park Drive, and the Sonoma County Water Agency – Petaluma Aqueduct would be utilized for water service. It was also assumed that appropriate water conservation measures would be implemented, including a policy of using reclaimed wastewater to irrigate parks and landscaping.

The projected average water demand for the area of overlap is approximately 95 gpm. This estimate is derived from and approximately 15% higher than the projected wastewater flows outlined in Alternative A. This 15% increase is included in order to account for other water uses and system losses. This estimate also assumes that reclaimed wastewater would be used for irrigation as outlined in the Northwest Specific plan Policy.

Based on the City of Rohnert Park's water usage in 2003, about 47% of the supply came from imported water supplied by the Sonoma County Water Agency, while 53% came from groundwater (City of Rohnert Park, 2005). It was assumed that similar percentages of water would be supplied to the project. Assuming this same percentage of groundwater would be used to supply the Northwest Specific Plan in the area of overlap, about 50 gpm of the projected water demand would be expected to come from groundwater, and 45 gpm from imported water.

### **2.7.2 Wastewater**

The expected wastewater generation for the Northwest Specific Plan and for the area of overlap with the Wilfred site is discussed in detail in Alternative A. The reader is referred to that section for additional information.

### **2.7.3 Effluent Disposal**

In the Northwest Specific Plan it was assumed that new gravity sewer infrastructure would be developed to carry effluent to the Rohnert Park pumping station. It was anticipated that a new sewer main would be installed in Dowdell Avenue as it crosses Business Park Drive to the south to the existing pumping station. Additionally it is expected that some existing sewer and sewage treatment infrastructure would have to be increased in size as discussed in Alternative A. The reader is referred to that section for additional information.



## **SECTION 3: LOCAL HYDROGEOLOGY**

This section presents a summary of the available information regarding the hydrogeology at the two candidate Project sites. The local hydrogeology for both the Wilfred and Stony Point are discussed below.

### **3.1 Rohnert Park Hydrogeology**

Sonoma County is underlain by an assortment of geologic materials ranging in age from Jurassic to Recent. Most, if not all, of these materials yield groundwater to some degree in wells. The quality of the water ranges from nonpotable to excellent, with much of the nonpotable water occurring near San Pablo Bay or the Pacific Ocean. The best yields of water are from wells drilled adjacent to flowing streams.

A review of the local hydrogeology indicates that there are regional groundwater issues associated primarily with the over-drafting of local aquifers. The presence of an existing large diameter agricultural irrigation well on-site and the proximity of large capacity City wells near the Wilfred and Stony Point sites suggest that on-site wells will be able to meet the water demands of the Project.

The geological deposits that underlie Rohnert Park consist of alluvium and alluvial sand deposits to approximately 100 feet (below ground surface), the Glen Ellen Formation to approximately 600 feet, the Merced Formation from approximately 600 to 1,100 feet, and the Sonoma Volcanics underlying all. City Staff report that there is a significant difference in aquifer properties between the East and West half of the City of Rohnert Park. Much of the City east of Highway 101 is reported to have shallow, low-yield aquifers. City wells in East Rohnert Park are reported to influence neighboring domestic and agricultural wells. The City of Penngrove, located to the southeast of Rohnert Park, recently prevailed in a lawsuit to limit the City's ability to extract groundwater from their wells. Aquifers on the west side of Rohnert Park are reported to have markedly different characteristics, with the City wells generally terminating in deeper, more productive aquifers separated by aquacludes. Domestic wells in the west area are typically terminated between 100 and 200 feet in depth, while City wells are generally completed between 500 and 1,000 feet in depth.

The following sections describe some of the geotechnical characteristics underlying the Wilfred and Stony Point sites, which include the Glen Ellen Formation, the Merced Formation, and the Sonoma Volcanics.

#### **3.1.1 Glen Ellen Formation**

The Glen Ellen Formation is of Plio-Pleistocene age and was first described by Weaver (1949) from outcroppings of poorly sorted clays, sands, gravels, and cobbles occurring near Glen Ellen in the upper part of Sonoma Valley. Not always recognized as a separate formation, the Glen Ellen Formation also has been identified as the "Fresh-Water Merced" by Johnson (1934), the upper part of the "Sonoma Group" by Gealey (1951), and as "Older Alluvium" by Travis (1952). Later work by Cardwell (1958), Kunkel and Upson (1960), and Cardwell (1965) fully defined the formation and its mapped area to its present limit. Exposures of the Glen Ellen Formation, as

now mapped, extend from near Sonoma, on the south, through the central part of the Santa Rosa Plain, to Alexander Valley and Dry Creek Valley on the north.

The Glen Ellen Formation is composed of an extremely heterogeneous mixture of pale buff clay, silt, sand, and gravel; some lignite has been noted. Many beds grade laterally from coarse gravels into clay. The coarse materials are usually of andesitic composition, although some obsidian is present. Particle size ranges up to 6 inches (15 centimeters) in diameter. Near the town of Glen Ellen, a section of the Glen Ellen Formation was measured by Cardwell (1958). The section had a total thickness of 68 feet (21 meters); 18 feet (5 meters) of section was composed of fine to coarse-grained cross-bedded sandstone and conglomerate, the remainder being siltstone with lenses of coarse sand and pebbles. Beds of coarse pebble conglomerate occur in the Rincon Valley area. These beds dip nearly vertically and are believed by Cardwell (1958) to cause artesian conditions in wells located in Township 7 North, Range 7 East, Sections 8 and 9.

The Glen Ellen Formation is up to 3,000 feet (900 meters) thick. It has been deposited in several parallel troughs as a deposit of coalescing piedmont and valley alluvial fans; some clayey portions were deposited in a lagoonal environment. Much of the Glen Ellen overlies the Sonoma Volcanics with some degree of unconformity. At a few localities, it is intercalated with volcanic materials belonging to the Sonoma Volcanics. Likewise, much of the Glen Ellen is known to uncomfortably overlie sediments of the Merced Formation. Some beds of the continental Glen Ellen, however, are interfingering with beds of the marine Merced Formation. In a few areas, beds of the Glen Ellen directly overlie nonwater-bearing rocks of the Franciscan Group. In the lower Sonoma Valley area, the sediments of the Glen Ellen Formation are believed by Kunkel and Upson (1960) to grade laterally into beds of the contemporaneous Huichica Formation.

Groundwater in the Glen Ellen Formation has a greater range of character than any other formation in Sonoma County. Some of the best and some of the poorest quality water are obtained from this formation. Wells generally 100 feet (30 meters) deep yield a magnesium-bicarbonate water of moderately good quality; unusually high content of nitrate ion may be present. Wells up to 800 feet (243 meters) in depth yield moderately good quality sodium bicarbonate water. Very deep wells, such as those greater than 1,000 feet (300 meters), yield poorer quality sodium bicarbonate water. At scattered localities throughout the formation, boron concentrations of up to 1.0 mg/l have been reported, as has water containing over 90 percent sodium.

The Glen Ellen Formation is highly variable in its water-yielding capability. In the Santa Rosa Plain area, wells tapping this formation generally yield adequate supplies for domestic use, stock watering, or limited irrigation. Yields usually range from 15 to 30 gpm (57 to 113 l/m), with drawdowns of about 10 to 50 feet (3 to 15 meters). Specific capacities, based on bailer tests, range from 0.5 to 20.0 per foot (6 to 248 l/m per meter) of drawdown. The highly variable nature of the formation is indicated by yield data from two wells in Section 12, Township 7 North, and Range 7 West. One well near Piner Road produced 40 gpm (151 l/m) with a 2-foot (0.6-meter) drawdown. The standing water level in this 102-foot (31-meter) well was reported to be 10 feet (3 meters). The well log indicated a total of 17 feet (5 meters) of "large gravel and sand," with the remainder being "sandy clay, blue clay, and gray clay."

### 3.1.2 Merced Formation

The Merced Formation is one of the principal water-producing formations in Sonoma County. The formation consists of massive beds of fine to very fine-grained sandstone which is exposed over a broad area extending from Petaluma, on the south, to the Russian River, and from the west edge of the Santa Rosa Plain westward to beyond Occidental. Exposures of pebble conglomerate and siltstone in the area east of Cloverdale have also been included in the Merced Formation, although the exact stratigraphic relationship of this latter unit is not clear. In the subsurface, the Merced Formation has been identified at depth beneath the Santa Rosa Plain as well as beneath a cover of younger alluvium in Petaluma Valley.

The color of the Merced sandstone ranges from red, to orange, to white in exposed sections and from blue to gray in the subsurface where the beds have been under reducing conditions since deposition. Many well drillers report "clam shells" and "oysters" when drilling in the Merced Formation, indicating the wells have penetrated one of the numerous fossiliferous zones known to exist throughout the formation. Paleontological studies reported by Cardwell (1959) show that most shells belong to five reported species of pelecypods and four of gastropods. So abundant are many of the shell beds that they resemble coquina.

Much of the sandstone is loose and poorly cemented, although some beds, principally the more fossiliferous ones, are cemented to some degree with calcium carbonate and iron oxide. Near the base of the formation, there is a bed of white tuffaceous material about 10 feet (3 meters) thick. This bed is exposed near the western edge of the outcrop area where it can be seen as white patches on the hillsides. Interbedded with the beds of the Merced Formation are several beds of tuff breccia, one of which attains a thickness of 10 feet (3 meters). Whether these tuff breccia flows represent distal ends of flows from the Sonoma Volcanics or whether they are from some local source is not known. Johnson (1934) found a volcanic neck northeast of Bodega and suggested that as a possible source. Travis (1952), however, stated that there is no evidence to support this view.

The Merced Formation is of late Pliocene age and was deposited in a subsiding embayment that was open to the ocean. Cardwell (1959) has postulated that the Merced sediments were derived from older Franciscan rocks to the north and were brought southward by a major trunk stream to be deposited in a lagoonal environment that was protected from the ocean by an offshore bar. The sediments were deposited on a surface of high relief carved into the underlying Franciscan sediments. Occasional outliers of Franciscan rocks seen today surrounded by Merced sediments represent former islands that were partially buried during Merced sedimentation.

The Merced Formation has been estimated by Cardwell (1959) as being not over 2,000 feet (600 meters) thick; however, Travis (1952) estimated the total thickness of the Merced as being only 500 feet (150 meters). Well log data developed during the present study suggest that the Merced is at least 1,000 feet (300 meters) thick.

Groundwater in the Merced Formation is of excellent quality and varies from calcium bicarbonate and magnesium bicarbonate to sodium bicarbonate in composition. Typical conductivities range from 140 to 420  $\mu$ mhos. Wells tapping unoxidized (blue) sandstone may yield water containing excessive amounts of iron and manganese.

The Merced Formation produces large quantities of groundwater. The specific yield of the formation ranges from 10 to 20 percent, an unusually high value. This high specific yield is due to the preponderance of even-grained sand found in wells to depths of over 400 feet (120 meters). Yields of wells tapping this formation frequently produce from 20 to 1,000 gpm (76 to 3,780 l/m); drawdowns are minimal, usually from 10 to 150 feet (3 to 45 meters). Domestic wells perforated for only a short distance produce adequate yields for household use, even if wells are located on adjacent lots and lot size is minimal. Deep wells, usually irrigation or municipal, typically are gravel-packed.

Specific capacities of wells, based on bailer tests, indicate that the Merced sands yield about 0.1 to 5.0 gpm per foot (1.2 to 62 l/m per meter) of drawdown. For example, one well drilled along Liberty Road west of Petaluma had a total depth of 163 feet (49 meters). Of this depth, 160 feet (48 meters) was logged as "yellow sand, blue sand, sandstone ledges, and streaks of shells." Tested with a bailer, the well yielded 30 gpm (113 l/m) with a drawdown of 110 feet (34 meters); the standing water level was at a depth of 40 feet (12 meters). These data indicate a specific capacity of 0.27 gpm per foot (3.3 l/m per meter) of drawdown. Farther north, a 385-foot (117-meter) domestic well was drilled on Baker Lane, near Sebastopol. The first 3 feet (0.9 meters) was reported to be "topsoil"; the remaining depth of the well was reported as "sand, yellow sandstone, and blue sandstone." Blank casing was installed in the well to a depth of 270 feet (82 meters). Tested with a bailer, the well produced 16 gpm (60 l/m), with a 30-foot (9-meter) drawdown. The depth to standing water was reported to be 50 feet (15 meters). These data indicate that the specific capacity of the well was 0.53 gpm per foot (6.6 l/m per meter) of drawdown.

Reported standing water levels ranged from 35 to 60 feet (11 to 18 meters). Statements from well owners in the area indicate that water levels decline markedly during the summer months and many wells go dry by early fall. Based on an approximate aerial extent of 8,000 acres (3,200 hectares) and an average saturated thickness of 50 feet (15 meters), the Ohlson Ranch Formation has an estimated maximum storage capacity of about 25,000 acre-feet (30 hm<sup>3</sup>). This total probably is significantly less when water levels have declined to their lowest levels.

### **3.1.3 Sonoma Volcanics**

The Sonoma Volcanics were named by Weaver (1949) for a thick sequence of volcanic ejecta and related volcanic sediments that are exposed in the Sonoma Mountains. Weaver identified related volcanic materials, also assigned to the Sonoma Volcanics, occurring in the Mayacmas Mountains and the mountains separating Sonoma Valley from Napa Valley. Cardwell (1958) extended the volcanic sequence to include isolated volcanic exposures to the west of the Santa Rosa Plain. The Sonoma Volcanics comprise a great thickness of mixed volcanic materials consisting of flows, dikes, plugs, and beds of andesite, rhyolite, basalt, tuff breccia, agglomerate, tuff, and related intermediate to acidic flow rocks. Banded flows of welded tuff, perlite, and obsidian occur locally. Some obsidian zones are up to 10 feet (3 meters) in thickness and range from glassy to porphyritic. Volcanic ejecta comprise some 60 percent of the total mass, with the remainder being composed of a variety of volcanic-related sediments such as black volcanic sandstone, ashy clay, tuffaceous sandstone, and diatomite. It is this latter, the diatomite, which allowed for the dating of a part of the Sonoma Volcanics. Axelrod (1944) studied samples of the Sonoma diatomite and identified it as being middle to late Pliocene in age, based on plant fossils contained therein.

The Sonoma Volcanics accumulated in a basin that was some 30 miles (48 kilometers) wide in an east-west direction and 40 miles (64 kilometers) long from north to south. With a maximum thickness of well over 1,000 feet (300 meters), the volcanics cover an area of about 350 square miles (91 square kilometers). The volcanics usually overlie the older Juracretaceous sediments with a pronounced unconformity. Certain parts of the volcanics interfinger with partly contemporaneous beds of the Petaluma, Merced, and Glen Ellen Formations. In some areas, the volcanics uncomfortably overlie or are in fault contact with the Petaluma Formation.

Lower portions of the Sonoma Volcanics are strongly deformed because of intense folding and faulting. This condition and the extreme lateral variability of the flows make it nearly impossible to trace flows and beds over any great lateral distance. According to Huffman (1971), upper portions of the Sonoma Volcanics are but little deformed and occur as gently sloping flows of basalt and andesite. In the Sonoma Valley area, Kunkel and Upson (1960) reported a great number of thick flows of tuff breccia containing blocks of andesite up to 4 feet (1.2 meters) across contained in a matrix of fine-grained ash. Also noted were locally abundant beds of red scoria having high permeability. In contrast to the andesitic nature of the Sonoma Volcanics found elsewhere, the volcanics in Alexander Valley are composed of basaltic flows and related material. Many of the basalt flows are up to 100 feet (30 meters) in thickness; pillow structure is common.

Groundwater in the Sonoma Volcanics usually is satisfactory quality sodium bicarbonate water. Boron concentrations of up to 1.0 mg/L have been reported. Because of a higher than usual geothermal gradient, some groundwater from deep wells in the volcanics is warmer than that found at equal depth in other formations. The unusual gradient illustrated by the water from Well 7N/7W-32G1, which is 403 feet (123 meters) deep and produces water with a temperature of 74°F (23 C), a temperature somewhat warmer than that of usual groundwater. The productivity of water wells drilled into the Sonoma Volcanics is highly variable and unpredictable. In some areas a driller might complete a well producing adequate quantities of water for domestic use, while only a short distance away a nonproducer, or dry hole, had previously been drilled. In general, successful wells drilled into the volcanics should yield from 10 to 50 gpm (38 to 189 l/m) and drawdowns should range from 10 to 120 feet (3 to 37 meters). Because of the large expected drawdowns and the fact that standing water may be as deep as 200 to 300 feet (60 to 90 meters), domestic wells ranging in depth to 500 feet (150 meters) are not uncommon.

### **3.2 Sonoma Hydrogeology**

Available geotechnical and geologic information for the Alternative F site includes the following:

- Well logs for an observation well drilled near the Wilfred and Stony Point sites
- Geotechnical Report for the property to the south of Highway 37 near Lakeville Road

A brief summary of this information follows below. Should Alternative F be selected as the site for the project, a site specific geotechnical report would need to be prepared.

**Well Logs:** An observation well was drilled approximately 100 feet east of the water well drilled at the Sonoma site. The well log for this well shows the groundwater table extending to 34 feet

below grade. The well has a 46-foot deep layer of Younger Bay Mud, underlain by Alluvium. No boring was conducted below 71.5 feet bgs.

**Geotechnical Study:** The following description of the soil and geologic conditions at the site are excerpted from the Draft Geologic and Geotechnical Feasibility Investigation prepared by Geocon Consultants, Inc. on June 9, 2003. The report concluded that development was not precluded by the soil and geotechnical conditions observed at the site. A description of the soil and geologic conditions at the site follows. It must be noted that prior to any construction on the site, additional work associated with the preparation of a geotechnical report is required. However, the study provides a summary of the site's soil and geologic conditions.

Four general soil types were observed at the site. The soil types include, in order of increasing age: artificial fill, bay mud, alluvium, and Tertiary-age Upper Petaluma Formation. In general, the alluvium is the result of the weathering of formational material. The Bay Mud is the result of sedimentation within the Bay. The alluvium forms an apron that generally divides the Bay Mud from the formational material and may interfinger with the Bay Mud. The site is underlain by either Bay Mud or formational or alluvial deposits. Each type of soil is described below. For more information about the extent of each type of soil, the reader is referred to the original report.

### **3.2.1 Artificial Fill (af, afbm)**

In general, the artificial fill material at the site is located within roadway or railroad improvements adjacent to the site. This material is mapped as artificial fill (af) and artificial fill placed over bay mud (afbm). It is assumed that the artificial fill has been placed in accordance with the guidelines of a construction quality control program with some degree of compaction. Therefore, the engineering properties of these materials are anticipated to be good. Exploratory excavations within the artificial fill material were not performed as a part of this study. Further evaluation of the existing artificial fill will be necessary if structural improvements are planned within this material.

### **3.2.2 Alluvium (Qal, Qhf, Qpf)**

The alluvial material observed at the site was (and is) derived from adjacent formational units. The alluvium is subdivided into alluvium (Qal), Holocene alluvial fan deposits (Qhf) and Pleistocene alluvial fan deposits (Qpf). In general, the composition of the different alluvial types is similar. The alluvium generally consists of dense and stiff mixtures of sand, silt, clay, and gravels. Similar to the Upper Petaluma Formation, portions of the alluvium also contains thin layers of fat, potentially expansive clay (CH). The engineering properties of the alluvium is generally good, however, areas within active drainage swales may contain loose materials that would not be suitable for support of structures. Further evaluation of alluvium within the existing drainage swales will be necessary if development is planned in those areas.

### **3.2.3 Bay Mud (Qhbm)**

Holocene age Bay Mud deposits (Qhbm) are present within the lowland portion of the site. In general, the ground surface of the Bay Mud deposits is at or slightly above sea level. Based on the degree of consolidation and stratigraphic position, the sediments that comprise the Bay Mud

can be subdivided into three subunits: Younger Bay Mud, Older Bay Mud and an alluvial sand unit that sometimes separates the two. These three subunits were observed at the site during exploratory activities.

**Younger Bay Mud:** The Younger Bay Mud at the site generally consists of very soft, saturated silty clay (CH) with varying amounts of decomposed organics. Very little (if any) fine sand was observed within the samples of the Younger Bay Mud. The material is firm in the upper five to six feet bgs due to drying and The very soft consistency of this deposit was evidenced by Standard Penetration Test (SPT, see Appendix A) blow counts less than five and very little tip resistance on the CPT cone. The engineering properties of Younger Bay Mud are very poor. The material has a high moisture content, low dry density, is very weak and compressible. This material is sensitive, it swells when wet and desiccates when dried. Furthermore, this material loses approximately 50% of its strength when disturbed. The Younger Bay Mud at the site extends from the ground surface to a depth up to approximately 60 feet bgs. The deposit is thickest near the southwest corner of the site and gradually diminishes toward the north and east.

**Alluvial Interface Sand Deposit:** The alluvial sand deposit located at the interface between the Younger and Older May Mud generally consisted of dense, gravelly, silty, clayey sand (SM, SC). In general, the engineering properties of this material are good. The granular nature provides increased shear strength. This deposit was observed to be approximately 10 feet thick within the one of the on-site borings, and was interpreted to be approximately the same thickness in the CPT soundings.

**Older Bay Mud:** The Older Bay Mud at the site generally consists of stiff to very stiff, silty clay (CL, CH) and clayey silt (ML). Based on the CPT soundings, the Older Bay Mud extends to depths up to 140 bgs. Unlike the Younger Bay Mud, the engineering properties of this material are good. The material properties are usually adequate to support most pile foundations.

Similar to the Younger Bay Mud deposits, the deposit is thickest near the southwest corner of the site and gradually diminishes toward the north and east. This material is likely underlain by alluvial sands, gravels and clays or formational material of similar composition.

### **3.2.4 Upper Petaluma Formation (Tpu)**

Within the eastern portion of the site, the Upper Petaluma Formation consists of severely weathered material generally comprised of stiff to hard, silty, sandy lean clay (CL). This material has likely weathered from sandstone and siltstone. The severe degree of weathering has eliminated any visible bedding planes within this material. This material exhibits rock-like structure below approximately six feet bgs; however, the material remained readily excavatable to the backhoe and exploratory drill rig. The upper one to 1-½ feet of this material consists of highly plastic fat clay (CH) residual soil. It is anticipated that this material has a moderate to high potential for expansion due to seasonal moisture variations. In general, the plasticity of this material decreases with depth. Other than the expansive nature of the surficial residual soils, the engineering parameters of this material are quite good.



## **SECTION 4: BACKGROUND AND REGULATORY ISSUES**

This section identifies the typical regulatory requirements applicable to Alternative A with respect to the proposed water supply, wastewater treatment, and wastewater discharge methods identified in this report. Alternative A is referred to in this section as the Project, since the requirements for Alternative A meet or exceed those for the other alternatives in relation to water supply issues.

### **4.1 Water Supply**

In general, Sonoma Valley water supply issues are characterized by limited groundwater supply and over committed surface water supplies. The three primary options that exist for securing water for the Project include:

- Obtaining a water service connection from the City of Rohnert Park.
- Purchasing a water allocation through an outside agency.
- Constructing or purchasing water supply wells.

#### **4.1.1 City of Rohnert Park**

The City of Rohnert Park is the local water retailer providing potable water service to the area to the east of the proposed Wilfred site. The City gets water from two sources – a series of water wells, and a surface water supply from the Sonoma County Water Agency (SCWA). The City has 39 operational water supply wells supply approximately half of the City's current demand of 7,800 acre-feet per year (4,800 gpm). The rated capacity of the City's well field is 6.3 millions of gallons per day (MGD). The City's SCWA connection supplies water to the City via a combination of treated surface water, and water from underground river collectors ("Ranney Collectors") to the City's system via the aqueduct system. The City may draw up to 15 MGD of water from the aqueduct, with an annual limit of 7,500 acre-feet.

The City recently prepared a 2004 City-Wide Water Supply Assessment (WSA), which evaluates potable water supplies and demands in the City of Rohnert Park through the year 2025. This assessment looked at two situations: normal year supply and demand, and temporary impairment of MOU water supplies from the Sonoma County Water Agency indefinitely. Even without the extra supply from the MOU, the City's preliminary WSA identified that the water supply is sufficient to meet anticipated water demands through the year 2025. It was noted that the WSA is being challenged in court. Due to ongoing court proceedings and their uncertain outcome, the City has stated that such a hook up does not appear to be possible in the foreseeable future due to uncertainty over the SB610 requirements.

Obtaining a will-serve agreement from the City could be subject to environmental review, political considerations, and public review and comment. The feasibility and costs associated with constructing new transmission facilities are also unknown.

#### **4.1.2 Outside Agency Allocation**

The Project could also potentially contract directly for a wholesale water supply allocation either from the SCWA, or from an agency independent of the SCWA. It is unlikely that SCWA would provide a wholesale contract due to its current commitments; however, it may allow a transfer ("wheeling") agreement for the delivery of third-party water through its system. Water purchased in this manner would have to be secured in the form of a long-term binding service contract in order to be considered as a firm source of supply.

Obtaining an external allocation, securing the permission of SCWA to wheel the allocation to the site, and constructing the transmission facilities to bring surface water to the site are major obstacles. Obtaining an outside allocation could be subject to environmental review, political consideration, and public review and comment. The feasibility and costs associated with constructing the transmission facilities are also unknown, and potentially significant.

#### **4.1.3 Groundwater Resources**

The following section is largely excerpted from the City of Rohnert Park's 2004 Water Supply Analysis and the Project geological reports.

Historically, groundwater sources served as the predominant source of supply. Future water sources are planned to be predominantly surface water from SCWA; these supplies would be supplemented by groundwater and also recycled water. Continued use of conjunctive water management is expected to enable the City to meet its future water demands to a 20-year horizon and beyond.

Beginning in 2003, the City shifted the source of its water supply from groundwater to imported water provided by SCWA. In the future, the City plans to pump from a lesser number of wells within its existing well field to supplement surface water supplies.

Due to the recent shift in the source of supply, imported water now constitutes a larger portion of the total City water supplies. Correspondingly, with the reduction in groundwater pumpage, groundwater levels have recovered to higher elevations. Intermediate zone wells (wells constructed with screen depths ranging from 200 to 600 feet), where the majority of Rohnert Park pumping occurs, have shown significant changes in groundwater elevations in response to pumping changes. Specifically, spring groundwater elevations observed in the Rohnert Park wells were generally stable when groundwater monitoring was implemented in 1977 to 1981, then a decline was observed from 1982 to 1989. Subsequently, groundwater levels stabilized at a lower elevation from 1990 to 1997. This was followed by a slight recovery from 1997 to 2002, and then a major recovery in 2003.

Historically, shallow zone wells (<200 feet deep) show no significant decline in spring water levels. Shallow wells are generally located on the periphery of the City, and the lack of decline in groundwater levels indicates that pumpage from the intermediate zone does not generally affect shallow zone water levels in these wells. Water level elevations in four shallow completion wells located south-southeast of Rohnert Park are stable historically. Additional water level data is not available for this area, including Penngrove.

Most groundwater in Sonoma County is of a quality suitable for domestic purposes. Water used for domestic purpose decreases in quality with an increase in salinity, iron and manganese, hardness, and total dissolved solids. Each of these four constituents is found in higher-than-normal concentrations in certain areas of Sonoma County. Only in a few areas are chemical constituents present which render the water non-potable.

Boron is also present in the water from a number of local wells. Although not a drinking water health hazard, boron may be injurious or toxic to a variety of plants and trees. Sodium, which can cause sodium toxicity to plants, is present in high concentrations in a number of wells throughout the county. Iron and manganese may be present in high concentrations. Neither iron nor manganese in water presents a health hazard. Iron will cause reddish-brown staining of laundry, porcelain, dishes, utensils, and even glassware. Manganese acts in a similar way but causes a brownish-black stain. Soaps and detergents do not remove these stains, and the use of chlorine bleach and alkaline builders (such as sodium carbonate) can actually intensify the stains. If these constituents are present in groundwater, treatment of the groundwater to remove these constituents is recommended.

The density of water wells, as well as the percentage of wells with sanitary seals, was also determined. In several typical local mile-square sections of land, over 100 water wells were identified; one section southwest of Sebastopol contains 180 water wells. In many sections with numerous wells, less than half of them have sanitary seals. In Sonoma County, there are at least 400 springs, many of which yield potable groundwater. There are also thermal springs yielding highly mineralized, non-potable groundwater.

Construction of an on-site well will be largely exempt from local environmental and public reviews associated with off-site impacts, but will be subject to Federal environmental and public reviews through the National Environmental Policy Act (NEPA) and regulatory oversight by the USEPA and the Indian Health Services (IHS).

Information was collected on local City domestic wells, nearby domestic wells, and existing wells located on the Wilfred site. This information is summarized in the following sections. Any identified issues associated with these water supply sources are also noted.

#### 4.1.4 City Wells

The City of Rohnert Park operates 39 water production wells. Of these, four City Wells (#7, #23, #24 and #41) are located in the general vicinity of the proposed Wilfred site. Well #24 was constructed adjacent to the property line, and a short distance from the proposed site. Well #41 is constructed a short distance southeast of the proposed site on the other side of Business Park Drive. A map showing the location of each of the local City wells is shown in **Figure 4-1**. Some general properties of these wells are shown in **Table 4-1**.

**Table 4-1: Selected City Well Properties**

Well Parameter	Well #7	Well #23	Well #24	Well #41
<b>General</b>				
In Service	No	Yes	No	Yes
Distance from Casino Site <sup>a</sup>	1 mile	½ mile	¼ mile	500 feet
<b>Screen Intervals</b>				

Well Parameter	Well #7	Well #23	Well #24	Well #41
First Screen	128'-140'	190'-200'	258'-298'	177'-207'
Second Screen	268'-280'	210'-220'	358'-378'	232'-252'
Third Screen	356'-390'	310'-320'	396'-405'	382'-392'
Fourth Screen	420'-460'	345'-370'	418'-428'	417'-421'
Fifth Screen	-	405'-580'	496'-536'	437'-447'
Sixth Screen	-	445'-450'	576'-582'	480'490'
Seventh Screen	-	485'-520'	-	557'-633'
Eighth Screen	-	560'-580'	-	658'663'
Completed Depth	475'	610'	600'	663'
<b>Pumping Characteristics</b>				
Casing Diameter	16"	24"	12"	10"
Pump Capacity	280 gpm	150 gpm	120 gpm	250 gpm
Standing Water Level	134'	136'	ND	87'
Pumping Water Level	188'	265'	ND	ND
<b>Water Quality Characteristics</b>				
Iron, mg/L (SMCL 0.300)	0.1	ND	ND <sup>b</sup>	150
Manganese, mg/L (0.05)	0.03	ND	ND <sup>b</sup>	40
Hardness, mg/L	170	67	57	100
Treatment Plant	No	No	Yes	No

Notes:

- a: Distances are measured from the well to the closest edge of main casino site
- b: Reported value – original well equipped with iron and manganese removal plant
- ND: No data

An analysis of the boring logs for the closest wells to the site, Well #23, #24, and #41, suggest that there are at least six distinct local aquifers between the ground surface and 600 feet in depth based on the chosen screen intervals.

The geophysical well log for Well #24 shows sand and pea gravel encountered to approximately 170 feet, consistent with shallow alluvium. The log also indicates several impervious clay and sandy clay layers between sand, sandstone and gravel stratum to 600 feet. This is consistent with the Merced formation, which is considered one of the higher-yielding aquifer formations in Sonoma County. The Merced Formation is further described in *Section 3.1.2*.

Separate, confined aquifers such as those evidenced by the well completion logs have two characteristics that affect well design:

1. In order to maximize production, wells must be screened in multiple zones since water cannot readily travel vertically through clay aquacludes.
2. Because of this characteristic, influence of un-pumped zones from lower, pumped zones is minimal.

Well #24 is no longer used by the City due to high levels of iron and manganese in the groundwater. Treatment for these constituents may therefore be required before use, since they are secondary water quality standards. Although iron and manganese pose no health risk per se, they may result in aesthetic impacts such as staining. The proximity of this well to the



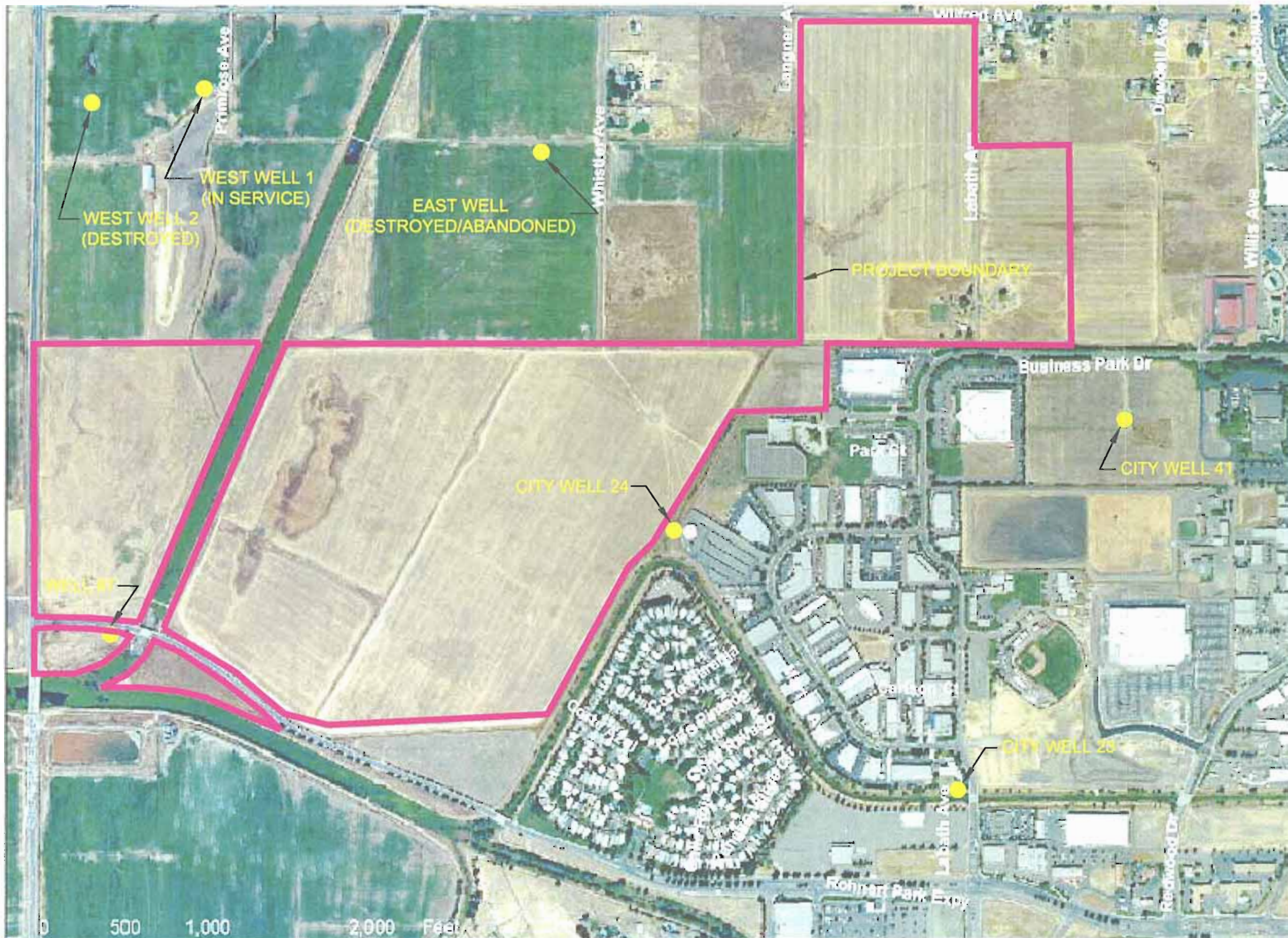

**FIGURE 4-1**  
**STATION CASINOS**  
**GRATON RANCHERIA HOTEL AND CASINO PROJECT**  
**LOCAL GROUNDWATER WELLS SITE MAP**



Wilfred site suggests that any groundwater pumped from on-site wells may require iron and manganese treatment before use.

The average water draw from the City's wells is approximately 100 gpm. Sonoma County considers Rohnert Park to be one of several regions in the County that is currently overdrawing groundwater. For this reason, it may be difficult to secure private well construction permits through the County. County permits, however, would not be required to construct wells on trust land.

**Adjacent Domestic Wells:** A review of the well drillers logs for City wells in the vicinity of the proposed Wilfred site show that the water bearing zones in the local soils are separated by impervious clay layers preventing the vertical movement of water from the upper bearing zones, where most domestic wells terminate, if the lower zones are being pumped. Local City wells are drilled to depths of between 475 – 660 feet. Three out of four City drilled wells near the proposed Wilfred site begin screening at depths below 175 feet. Most of the water extracted is from the deep zones.

Domestic wells, on the other hand, are not typically drilled to depths greater than 200 feet. This suggests that these wells draw from the shallow alluvial aquifer. City Staff has reported that there are no reports of significant drawdown of domestic wells resulting from operation of the City wells. To prevent significant impacts to local domestic wells, the proposed Project should also construct deep terminating wells, screen in the deeper water bearing formations below a depth of 200 feet, similar to the City's local well construction. It is not anticipated that properly constructed on-site wells for the Project will adversely affect local wells.

**Existing On-site Wells:** Four existing on-site wells (West #1, West #2, East, and Well #7), were located during the due diligence review. Additionally Komex identified two wells located on the northeast portion of the site included only in Alternative A, wells #58 and #38 in their report (Komex 2005). The locations of these wells are shown in **Figure 4-1**. Of these wells, West #2 and East are both abandoned and sealed. Their age is unknown, but they appear to have been constructed in the early 1900's. Well #7 is a small diameter well of recent construction, and is equipped with a small pump to feed cattle watering troughs. This well is too small to serve the requirements of the proposed Project.

West #1 is an old agricultural well that is currently still operational, and is presently equipped with a small submersible pump to supply cattle watering troughs, and barnyard wash water. The well has a 12-inch diameter casing and is equipped with a vertical turbine lineshaft pump. This pump was removed during the course of TV scanning operations. It is estimated that both the well and the lineshaft pump were installed in the 1950s.

A TV scan of Well #1 revealed that it is at least 610 feet deep. The well is likely deeper, however, the well casing bottom is full of sediment. The casing is rolled steel, perforated with vertical "mill slots" uniformly from top to bottom. All slots below 100 feet are severely plugged with corrosion, and few are identifiable past 200 feet. Numerous holes were found in the casing near the bottom, and the structural integrity of the well appears to be compromised. It was determined that this well should not be test pumped due to the risk of collapse, and permanent irreparable damage to the well. The well may be suitable for low volume pumping as it is presently used. The standing water level of the well was observed to be 110 feet.

The following conclusions can be drawn from an inspection of Well #1:

1. It was likely a high yield well with a capacity in excess of 300 gpm.
2. The severe iron bacteria plugging of the lower portion of the casing indicates that the most productive zones were in the lowest aquifers. The highest flowing zones tend to bring in the highest level of iron and bacterial nutrients, creating the worst fouling.
3. Water from this well would likely require iron and manganese treatment.

Komex well #58 is a shallow domestic well installed to a total depth of 120 and screened from 60 to 120 feet. Komex well #38 is a deep irrigation well constructed to a total depth of 1028 feet with an unknown screened interval. It is believed to be screened at similar depths as the City wells (Komex 2005).

## 4.2 Recycled Water

It is expected that the wastewater treatment plant will produce recycled water for on-site reuse, which will add to the water quality requirements of the effluent from the wastewater treatment plant. In order to reuse recycled water on non-trust land in California, a Title 22 reclamation permit would be required. The RWQCB typically issues this permit, and delegates the responsibilities for reviewing reclamation uses and permit administration to the California Department of Health Services (DHS). On trust land, the United States Environmental Protection Agency (USEPA) would regulate the use of recycled water use and would be responsible for granting a NPDES permit to use recycled water on-site. The USEPA has typically deferred their recycled water standards to California's Title 22 standards for trust land projects in California. Indian Health Services (IHS) would regulate the use of recycled water on trust lands. For the range of uses considered for this project, it would be expected that the wastewater treatment plant would need to produce disinfected tertiary recycled water in accordance with Title 22 requirements. Disinfected tertiary recycled water meets the following water quality requirements, which are specific to the MBR treatment process expected for the Project's wastewater treatment facility:

- Has been passed through a microfiltration, ultrafiltration, nanofiltration, or reverse osmosis membrane so that the turbidity of the filtered wastewater does not exceed any of the following:
  - o 0.2 NTU more than 95 percent of the time within a 24-hour period; and
  - o 0.5 NTU at any time.
- The filtered wastewater has been disinfected by either:
  - o A chlorine disinfection process following filtration that provides a CT (the product of total chlorine residual and modal contact time measured at the same point) value of not less than 450 milligram-minutes per liter at all times with a modal contact time of at least 90 minutes, based on peak dry weather design flow; or
  - o A disinfection process that, when combined with the filtration process, has been demonstrated to inactivate and/or remove 99.999 percent of the plaque forming units of F-specific bacteriophage MS2, or polio virus in the wastewater. A virus that is at least as resistant to disinfection as polio virus may be used for purposes of the demonstration. The median concentration of total coliform bacteria measured in the disinfected effluent



does not exceed an MPN of 2.2 per 100 milliliters utilizing the bacteriological results of the last seven days for which analyses have been completed and the number of total coliform bacteria does not exceed an MPN of 23 per 100 milliliters in more than one sample in any 30 day period. No sample shall exceed an MPN of 240 total coliform bacteria per 100 milliliters.

In addition to the aforementioned recycled water quality requirements, there are a number of operational, use, and reporting restrictions identified in Title 22. However, it is not expected that any of these requirements will limit the viability of recycled water reuse on-site, and these requirements are typical for any recycled water use application. All uses of recycled water would have to be approved by USEPA. As long as disinfected tertiary recycled water is produced, there would appear to be no issues associated with this intended use. It is also noted that the minimum quality of discharge to the Laguna is typically disinfected tertiary recycled water.

### **4.3 Wastewater**

The regulatory requirements pertinent to wastewater treatment and wastewater discharge methods are identified in *Section 2.1.3 Wastewater* and *Section 2.1.5 Effluent Disposal* respectively. The reader is referred to those sections for additional details. The projected effluent quality will be presented in the Engineering report, which will follow this feasibility study.

This section will present the requirements for determining the potential impacts of receiving waters upon discharge of tertiary treated wastewater, and the sludge disposal options and pertinent disposal regulations.

#### **4.3.1 Baseline Monitoring Program**

Baseline water quality for receiving waters, the Bellevue-Wilfred Channel and the Laguna, is required as a basis for determining if the beneficial uses of the receiving waters will be impacted by the proposed discharge of tertiary treated wastewater. Because there are no existing water quality criteria available for the receiving waters, this section presents a baseline monitoring program. The baseline monitoring program includes tests for pH, total nitrogen and some other parameters. The monitoring program and laboratory results are presented in this section.

The primary unknown regulatory issues associated with the proposed wet season discharge of wastewater to the Bellevue-Wilfred Channel is the surface water quality at the discharge location. Since there is an existing gage station at the Stony Point Road Bridge crossing Laguna, and streamflows are highest at that location, this was a logical area to begin baseline water quality monitoring.

In order to begin detailed discussions with the RWQCB on the feasibility of discharging to the Bellevue-Wilfred Channel, the Project elected to begin collect receiving water quality data near the Stony Point Road Bridge. This data would help the RWQCB evaluate the background water quality of the receiving waters, identify potential water quality restrictions, and understand the impacts of the proposed new discharge on the aquatic habitat. These parameters were selected in order to better determine if the proposed surface water discharge would impact the beneficial uses of the Bellevue-Wilfred Channel and the Laguna. Since no water quality data

was immediately available, it was recommended that monthly samples be collected and analyzed for the water quality parameters identified in **Table 4-2**. All samples collected in the field were grab samples collected near the Stony Point Road bridge crossing of Laguna.

**Table 4-2: Receiving Water Quality Baseline Monitoring Program**

Parameter	Sample Frequency
pH	Monthly (lab)
TDS (mg/L)	Monthly (lab)
TSS (mg/L)	Monthly (lab)
Specific Conductivity (umho/cm)	Monthly (lab)
Hardness (mg CaCO <sub>3</sub> /L)	Monthly (lab)
Turbidity (NTU)	Monthly (lab)
Nitrate (mg-N/L)	Monthly (lab)
Nitrite (mg-N/L)	Monthly (lab)
Ammonia (mg-N/L)	Monthly (lab)
TKN (mg/L)	Monthly (lab)
Total Phosphorous (mg-P/L)	Monthly (lab)
Orthophosphate (mg-P/L)	Monthly (lab)
Alkalinity (mg CaCO <sub>3</sub> /L)	Monthly (lab)
Carbonate Alkalinity (mg CaCO <sub>3</sub> /L)	Monthly (lab)
Bicarbonate Alkalinity (mg CaCO <sub>3</sub> /L)	Monthly (lab)
Hydroxide Alkalinity (mg CaCO <sub>3</sub> /L)	Monthly (lab)
Total Coliform (MPN/100 mL)	Monthly (lab)
Fecal Coliform (MPN/100 mL)	Monthly (lab)
Oil and Grease (mg/L)	Monthly (lab)

The results of the above baseline monitoring program are presented in **Table 4-3**. The reader is referred to the Engineering Report and NPDES Permit Application for more in depth information regarding the laboratory results.

**Table 4-3: 2004 Analytical Results for the Laguna de Santa Rosa at Stony Point Road Bridge**

ANALYTE	Method	MDL	Date						Avg
			01/05	02/06	03/04	04/07	05/05	05/20	
pH (units)	EPA 150.1	NA	7.06	7.22	7.42	7.37	7.26	7.3	7.27
TDS (mg/L)	EPA 160.1	10	260	180	1100	360	430	370	450
TSS (mg/L)	EPA 160.2	10	ND	ND	17	ND	30	260	56
Specific Cond. (umho/cm)	SM 2510	1.0	410	380	440	680	760	640	552
Hardness (mg CaCO <sub>3</sub> /L)	EPA 130.2	10	160	140	240	270	270	240	220
Turbidity (NTU)	EPA 180.1	4.0	9.4	19	8.8	4.8	24	89	25.8
Nitrate (mg-N/L)	EPA 300.0	0.20	2.3	1	1	0.39	ND	ND	0.85
Nitrite (mg-N/L)	EPA 300.0	0.20	0.07	0.076	ND	ND	NA	ND	0.15
Ammonia (mg-N/L)	EPA 350.3	0.25	0.38	0.22	0.38	0.15	0.099	0.42	0.27
TKN (mg/L)	EPA 351.2	0.50	3	4	1.4	0.82	0.83	1.6	1.9
Total Phosphorous (mg-P/L)	EPA 365.3	0.050	0.49	0.52	0.6	0.32	0.51	0.5	0.5
Orthophosphate (mg-P/L)	EPA 365.3	0.050	0.34	0.48	0.56	0.29	0.45	0.37	0.42
Alkalinity (mg CaCO <sub>3</sub> /L)	EPA 310.1	20	120	130	160	260	280	260	202
Carbonate Alkalinity (mg CaCO <sub>3</sub> /L)	EPA 310.1	20	ND	ND	ND	ND	ND	ND	ND
Bicarbonate Alkalinity (mg CaCO <sub>3</sub> /L)	EPA 310.1	20	120	130	160	260	280	260	202
Hydroxide Alkalinity (mg CaCO <sub>3</sub> /L)	EPA 310.1	20	ND	ND	ND	ND	ND	ND	ND
Total Coliform (MPN/100 mL)	SM 9221	2.0	900	1600	220	900	240	1600	910
Fecal Coliform (MPN/100mL)	SM 9221	2.0	900	1600	300	80	240	1600	787
Oil and Grease (mg/L)	EPA 413.1	5.0	ND	ND	ND	ND	ND	ND	ND

Notes:

MDL = Method Detection Limit, the minimum concentration of a substance that can be measured

ND = Not Detected

NA = Not Available

<sup>1</sup> Not detected results were assumed to be present at the Reporting Limit for the calculation of the average value.

Two special samples, one during the wet season and one during the dry season, were collected and analyzed for trace metals and California Toxics Rule pollutants. The laboratory analysis methods identified in Table 4-4 were used to test for 126 pollutants and approximately 40 trace metals.

**Table 4-4: California Toxics Rule and Trace Metals Laboratory Tests**

Parameter	Laboratory Analysis Method
Volatile Organics	EPA 624
Semivolatile Organics	EPA 625
Pesticides & PCBs	EPA 608
Polynuclear Aromatic Hydrocarbons	EPA 610
Organophosphorus Pesticides	EPA 614

Parameter	Laboratory Analysis Method
Low Level Mercury	EPA 1631
Metals by EPA 6020/200.8	EPA 6020/200.8
Cyanide, total	EPA 335.2
TriButyl Tin	GCFPD
EPA 1613 2,3,7,8 TCDD (Dioxin)	EPA 1613
Asbestos TEM	TEM
Chromium, hexavalent (colorimetric)	EPA 7196

The results for the California Toxics Rule and the Trace Metals laboratory tests results can be found in Appendix A.

The laboratory results indicated that metals at a concentration higher than the most strict, pertinent water quality criterion were not found. No CTR compounds were detected above the strictest applicable water quality criteria. Only four chemicals were found to be in valid samples: Toluene, Aldrin, Heptachlor, and acetone. The reader is referred to the Permitting Memorandum in the NPDES Application Package and Engineering Report for a more detailed discussion of the laboratory results.

#### 4.3.2 Sludge Disposal

Sludge (biosolids) produced by the treatment plant must also be disposed of in accordance with the California Code of Regulations, Water Code, Resource Conservation and Recovery Act, and the RWQCB policy. These regulations are commonly referred to as the 40 CFR Part 503 Biosolids Rule promulgated by the USEPA. It is anticipated that biosolids produced by the project wastewater treatment plant will be disposed of to an off-site landfill in accordance with all regulatory requirements. Prior to off-site disposal, biosolids will be stored on-site in a solids stabilization basin. Periodically, as biosolids accumulate in the solids stabilization basin, biosolids will be trucked off-site for disposal.

## SECTION 5: WATER FACILITY REQUIREMENTS

This section identifies preliminary water supply, water treatment, water storage, and pumping requirements to supply Alternative A with water. Alternative A is referred to in this section as the Project, since the requirements for Alternative A either meet or exceed those for the other alternatives in relation to water supply issues.

The facilities identified in this section are based on HSe's experience with similar projects. The general concept for the water supply facility is that the Project will maximize the reuse of recycled water in order to minimize the water supply requirements for the Project. This section describes the following facilities:

- Water Production Wells
- Water Treatment Plant
- Water Storage Tank and Pump Station

The overall water facilities will be located based on the final design of the Project facilities. All of the recommended water supply facilities described in this Chapter are preliminary, and should be utilized for planning purposes only.

### 5.1 Water Production Wells

The potable water supply system must have a firm reliable supply based on projected water demands. By definition, firm capacity is the remaining water supply capacity with the largest single source out of service. In a well system, it is generally recommended to have a minimum of two wells available for service, so one can be serviced without interrupting the water supply.

The wells are expected to alternate in use based on water supply requirements in order to equalize run times for equipment located on each well. Alternating well operation also helps maintain the viability of each well.

A key design requirement that must be addressed during the construction of the wells is the need to minimize impacts to neighboring domestic wells. The test hole should be drilled a minimum of approximately 650 feet deep, and screen sections should be placed primarily in the deeper aquifer sections, and not in the upper aquifers above 200 feet. The wells would be located in the proximity of the existing City Well #24, or in an area determined to be suitable within the developed area. The area near City Well #24 was selected due to its known water bearing capability and the anticipated negligible impact to City wells. The City has shutdown their only nearby well, which was known to contain high concentrations of iron and manganese. The utilization of a water treatment plant to remove iron and manganese, as described in *Section 5.2*, will probably be required to treat the well water. **Table 5-1** shows the recommended design criteria for on-site wells. Each well is expected to have an approximate footprint of 20 feet by 30 feet, including the pump, well, piping, and miscellaneous equipment.

**Table 5-1: Recommended Water Production Well Design Criteria**

Parameter	Value
Approximate depth	650 ft
Casing diameter	12-inch
Surface seal depth	100 feet minimum
Casing material	Copper bearing steel
Screen material	Wire-wrapped stainless steel
Approximate screen depth range	Between 200 ft and 650 ft
Pump type	Vertical turbine multistage
Method of control	On/off by tank level

## 5.2 Water Treatment Plant

Based on the groundwater conditions identified in Section 3, and the known iron and manganese issues found in local wells described in Section 4, it is anticipated that water supplied from any on-site well will exceed the State secondary drinking water standards for iron and manganese. Thus, an on-site water treatment plant to remove iron and manganese will be required. It is recommended that the treatment plant utilize a manganese greensand pressure filtration process, to remove iron and manganese to levels below 0.3 mg/L, and 0.05 mg/L, respectively. The backwash waste stream would be directed into a holding tank, and settled water would be recycled back into the front of the plant at a rate not exceeding 10% of the plant's rated capacity. Iron and manganese sludge would be periodically discharged from the tank to the sewer system. A typical layout of the iron and manganese plant is shown in **Figure 5-1**. A process flow diagram showing how water is treated within the treatment plant is shown as **Figure 5-2**.

The manganese filtration process consists of oxidation using a feed stream of sodium hypochlorite, and filtration through a manganese greensand filtration media. The function of the manganese greensand is to provide a catalyst to fully oxidize manganese, which may not be accomplished solely with a sodium hypochlorite oxidant. Potassium permanganate will be used to initially condition and prepare the media, and it may be used continuously or intermittently to aid in oxidation, if required. Sodium Hypochlorite would be used to disinfect the water before distribution. A continuous monitoring residual analyzer will monitor chlorine residual at the end of the filters, before entering a water storage tank. Chlorine dosage control would be manual, with options for automatic pacing based on residual. The water treatment plant process facilities would be located within an enclosed building.

Significant features of the plant would include:

- PLC control system interlinked to a common water/wastewater SCADA system.
- Surface wash to reduce the possibility of "mudball" formation on the media surface.
- Fail-safe control valves that would fail in the filter-forward mode of operation.

The recommended Water Treatment Plant design criteria are summarized in **Table 5-2**.



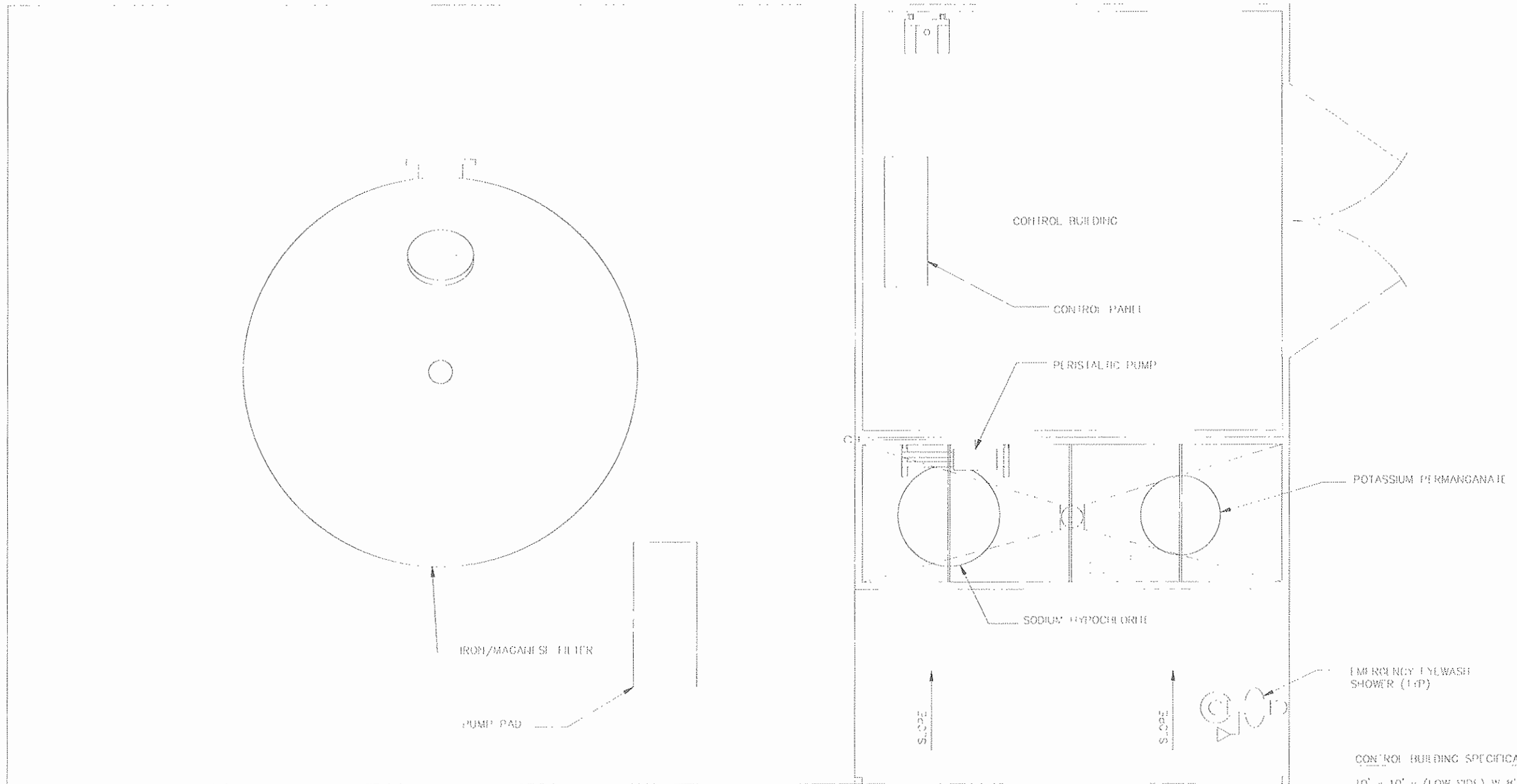

**SITE PLAN**  
SCALE: 1/2" = 1'-0"

**CONTROL BUILDING SPECIFICATIONS.**  
 10' x 10' x (LOW SIDE) W 8' x 10' CANOPY -  
 SHED STYLE 1:12 SLOPE  
 FRAME: 2" x 2" x 120 STEEL TUB  
 ALL WELDED WALL SECTIONS TO BE BOLTED IN FIELD  
 ROOF/SIDING: MLE ROY "MULTI-RIB"  
 28 GA RIBBED METAL PAINTED  
 DOOR: 6' x 6' 8" DOUBLE SWING STEEL OR ALU 16  
 SERIES FRAME W/ AIR SERIES DOOR W/ POLYSTYRENE CORE  
 LOCKS: L D SERIES 2/ORBIT STEEL KNOB AND  
 ENTRANCE LOCK  
 VENTS: 2 EACH 12" x 12" (NOMINAL)

**FIGURE 5-1**  
**STATION CASINOS**  
**GRATON RANCHERIA HOTEL AND CASINO PROJECT**  
**PRELIMINARY WATER TREATMENT PLANT LAYOUT**

PIPE SERVICE KEY

- BW BACKWASH
- D DRAIN
- FW FILTERED WATER
- KMN POTASSIUM PERMANGANATE
- OF OVERFLOW
- RW RAW WATER
- SW SURFACE WASH
- SCLS SODIUM HYPOCHLORITE
- SAM SAMPLE
- W WATER

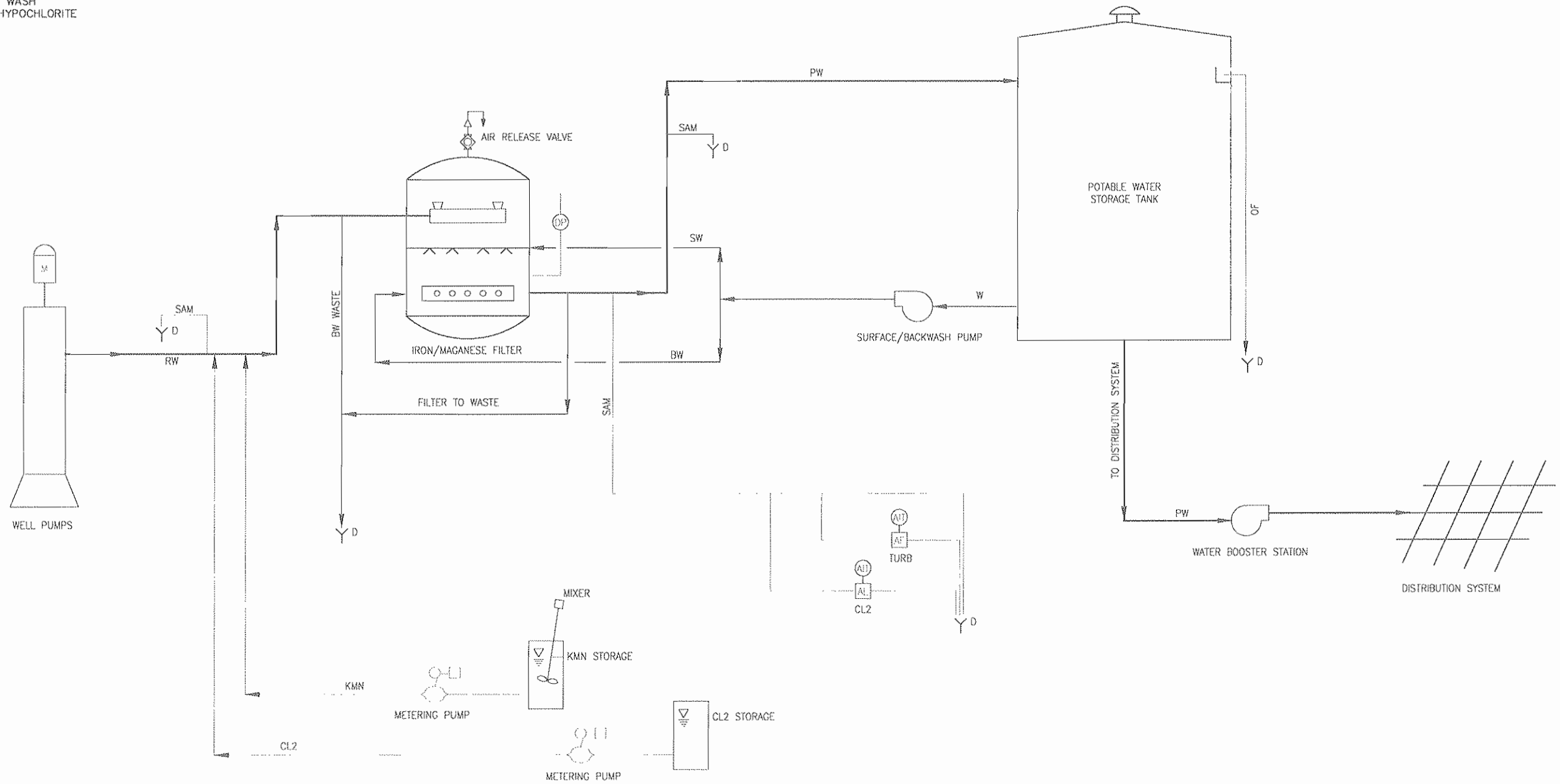

**FIGURE 5-2**  
**STATION CASINOS**  
**GRATON RANCHERIA HOTEL AND CASINO PROJECT**  
**PRELIMINARY PROCESS FLOW DIAGRAM**

**Table 5-2: Recommended Water Treatment Plant Design Criteria**

Parameter	Value
Process	Pressure filtration
Media	Anthracite/greensand
Number of filters	1
Filter loading rate	3 gpm/sf
Filter size	6 ft diameter x 72 in. high
Oxidant	Sodium Hypochlorite
Process control	PLC/on with service well

### 5.3 Water Storage Tank and Pump Station

A water storage tank would be constructed to store water produced by the water treatment plant. The actual required capacity of the tank is dependant on the Wilfred site's fire flow requirements, however, the anticipated capacity is approximately 1.2 million gallons (MG), and would be of welded steel construction meeting all American Water Works Association (AWWA) specifications for welded steel tanks. A typical section of a tank is shown in **Figure 5-3**. The tank would be a cylindrical shape. Having a shorter tank will make it easier to camouflage, and would hide the tank better from the site's guests. The tank sizing would be based on standard pre-engineered tank dimensions, which are typically in 8-foot increments. It is also possible that the tank would be partially or completely buried, but for the purposes of this analysis, it is assumed that the tank would be located at grade.

Since the site is largely flat, with no land at an elevation suitable for gravity feed to the distribution system, it is recommended that this tank be utilized as the supply, and a pump station be utilized to maintain pressure in the distribution system. This potable water pump station will be required to convey water from the storage tank to the facilities requiring potable water, and would be sized to handle both fire flow and domestic demands. The ultimate pumping capacity will be dependent on fire flow requirements, and would be satisfied by two fixed-speed high-service pumps that are half the capacity of the projected flow requirement. **Table 5-3** shows the design criteria for the water storage tank and pump station.

**Table 5-3: Recommended Water Storage Tank and Pump Station Design Criteria**

Parameter	Value
<b>Water Storage Tank</b>	
Approximate size	1.2 MG
Approximate diameter	80 feet
Approximate height	32 feet
Construction	Welded steel
<b>Potable Water Pump Station</b>	
Low service pump number	2
Low service pump type	Variable speed turbine
High service pump number	2
Hydropneumatic tank approximate size	2000 gallons

## SECTION 6: WASTEWATER FACILITY REQUIREMENTS

This section identifies preliminary wastewater collection, wastewater treatment, discharge, and recycled water facilities required to manage wastewater generated by the proposed Alternative A. Alternative A is referred to in this section as the Project, since the requirements for Alternative A either meet or exceed those for the other alternatives in relation to wastewater and recycled water issues.

The general concept for the wastewater facilities are to comply with all applicable permitting requirements, maximize on-site water reuse, and ensure that the wastewater and recycled water facilities are designed in a manner that does not limit existing uses or future expansion. This section describes the following facilities:

- Collection System
- Treatment Plant
- Discharge Facilities
- Operations and Maintenance
- Recycled Water Facilities

The overall wastewater facilities will be located based on the final design of the Project facilities. All of the recommended water supply facilities described in this Chapter are preliminary, and should be utilized for planning purposes only.

### 6.1 Wastewater Collection System

The backbone of the wastewater collection system will be a sewage transmission pipeline from the casino lift station to the headworks of the wastewater treatment plant. It is believed that due to the relatively flat site topography, the main pipeline to the wastewater treatment plant will be a pressurized force main. It is likely that a duplex wet well sewage lift station with a standby pump will be required to convey sanitary sewage to the treatment plant.

Recommended design criteria for the lift station are shown in **Table 6-1**. A figure showing a typical sewage lift station layout is shown in **Figure 6-1**. The station should be designed to lift the maximum daily flow with one pump out of service.

**Table 6-1: Recommended Sanitary Sewage Lift Station Design Criteria**

Parameter	Value
Purpose	Lift raw water to WWTP facilities
Type	Submersible non-clog centrifugal
Quantity	Three (2 duty, 1 standby)
Controls	Constant speed, level switch start and shutoff

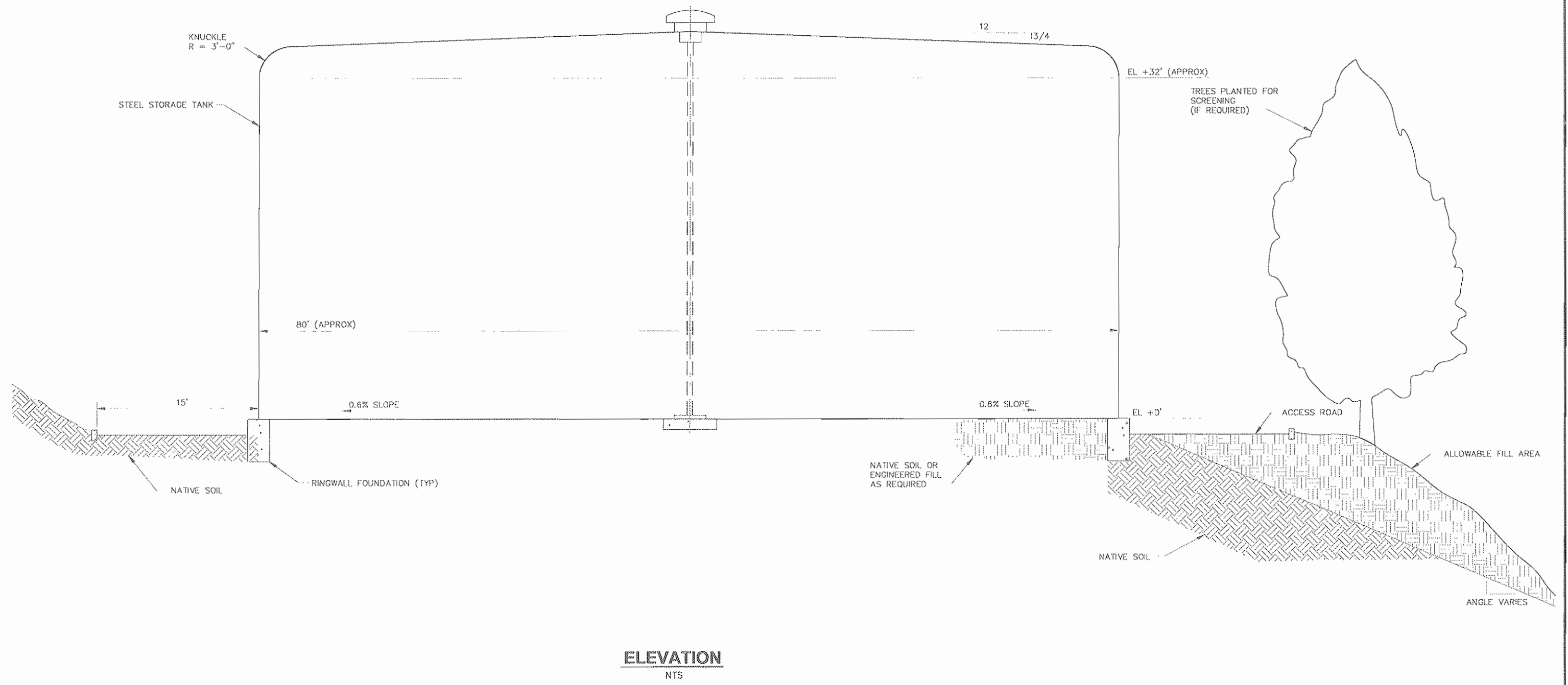

**FIGURE 5-3**  
 STATION CASINOS  
 GRATON RANCHERIA HOTEL AND CASINO PROJECT  
 TYPICAL POTABLE WATER STORAGE TANK

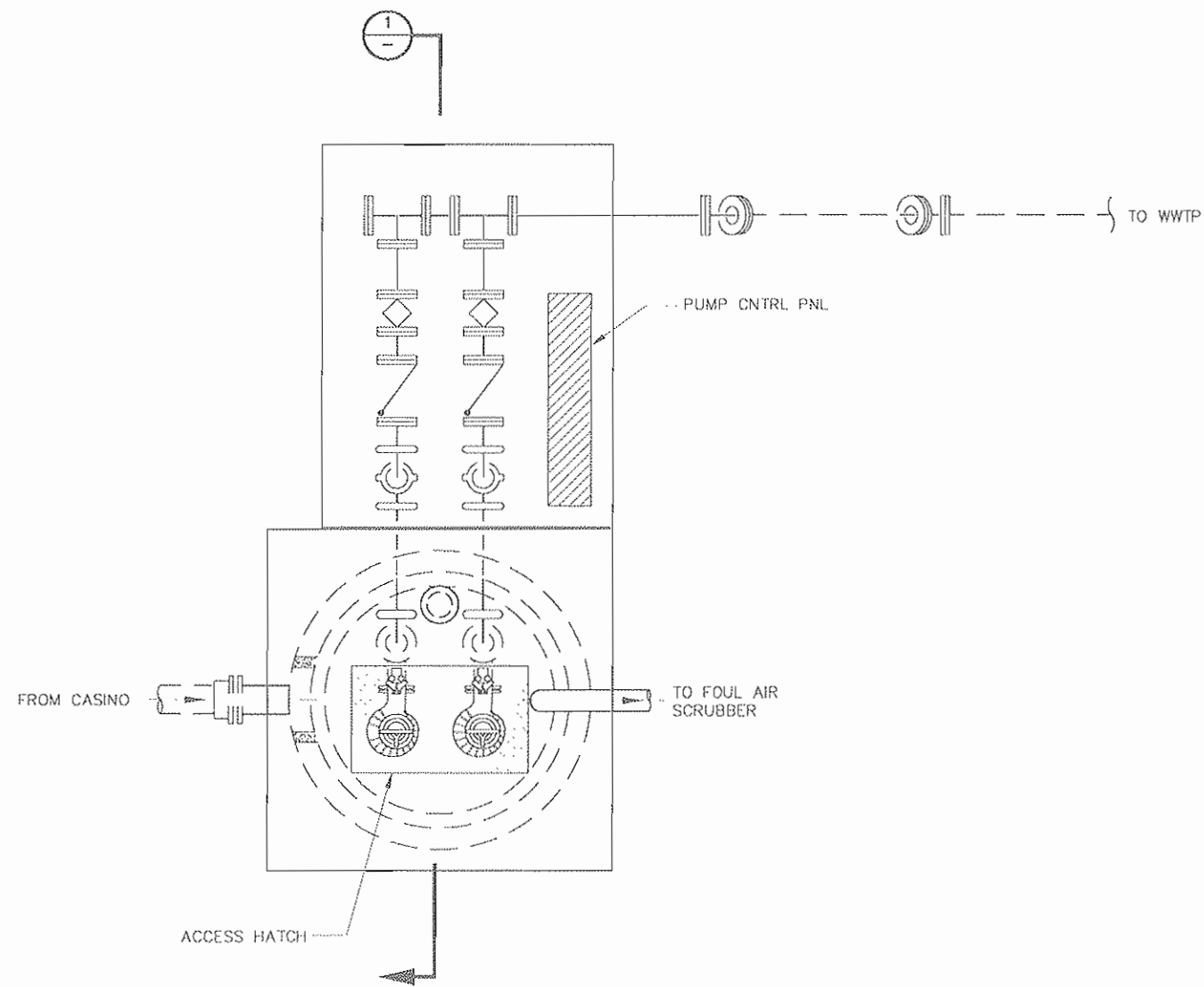

**TYPICAL LIFT STATION PLAN**  
SCALE: 1/4" = 1'-0"

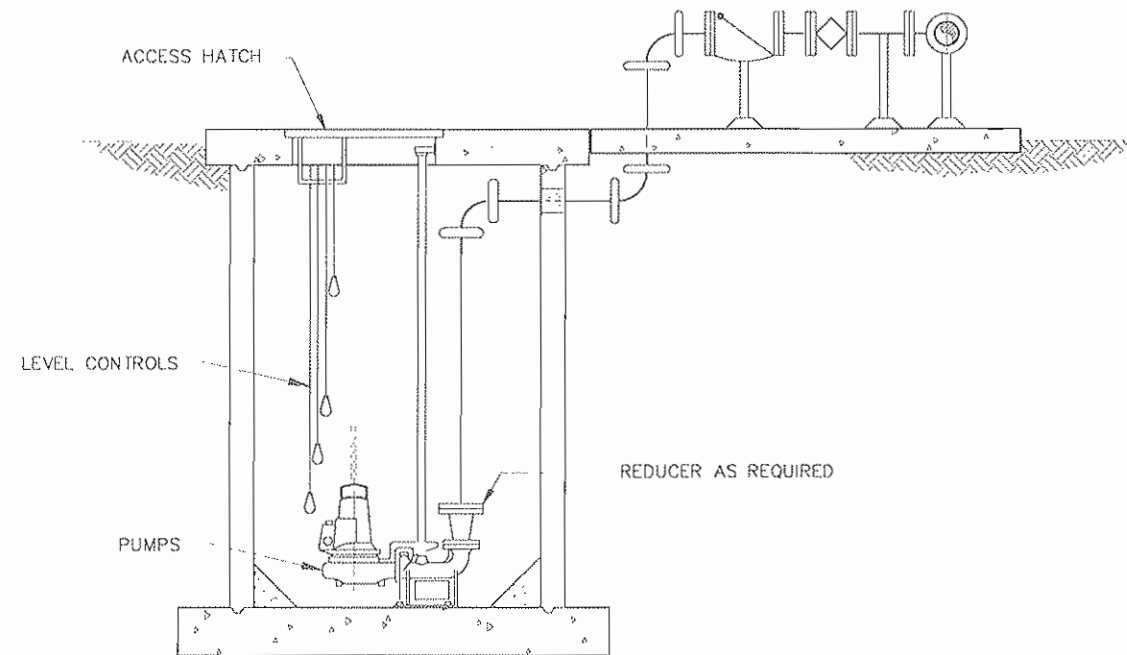

**SECTION 1**  
SCALE: 1/4" = 1'-0"



## 6.2 Wastewater Treatment Plant

This section provides a description of the recommended wastewater treatment facilities required for the Project. Each of the following major process components is described below:

- Headworks;
- Immersed Membrane Bioreactors;
- UV Disinfection;
- Chlorine Disinfection;

### 6.2.1 Headworks

The headworks for the wastewater treatment plant would typically include influent flow measurement, bar screens, and any required grit removal facilities. Due to the sources and quality of the wastewater, it is not expected that grit removal facilities are required at this time. However, bar screens are required to protect excessive fouling of the MBR membranes.

The raw influent would be pumped by the collection system pump station through the headworks facility. After flow measurement, influent would be routed to a covered headworks influent box for distribution to two influent channels. During normal operation, one channel would be in-service, with the other available as a standby. Slide gates would control flow to each channel. Each headworks channel would be sized to match the hydraulic capacity of the plant. Within the channels would be bar screens to remove large materials from the raw influent. A map showing a typical layout for the headworks facility is shown as **Figure 6-2**. **Table 6-2** shows some of the design criteria for the headworks facility.

**Table 6-2: Headworks Design Criteria**

Parameter	Value
Screening facilities	Enclosed cylindrical screen with 3-mm circular perforations, integral shaftless helical scraper/conveyor and compactor, mechanical washer to break up fecal material
Metering facilities	Magnetic flow meter on influent pipe
Odor control	Corrosion resistant plate covered channels, soil filter
Control	Continuous operation

### 6.2.2 Immersed Membrane Bioreactor System

An MBR wastewater treatment plant is recommended because of the ease of permitting the plant due to the high quality effluent, and the effluent's potential suitability for discharge. Sewage would travel between the headworks and the MBRs within a covered influent distribution force main. The force main would pass through headworks to an influent splitter box that would evenly distribute the flow to the two MBR process trains. Sluice gates would be provided to isolate basins for maintenance.

Each MBR process train is divided into two sections; an anoxic section, and an aerobic section containing the immersed membranes. A typical layout for the MBR is shown as **Figure 6-3**. The proposed design criteria for MBRs are shown in **Table 6-3**.

**Table 6-3: MBR Design Criteria**

Parameter	Value
<b>Design Flows</b>	
Average daily flow:	250,000 gpd
Peak daily flow:	400,000 gpd
Peak hour flow:	445,000 gpd
MBR process trains:	2
Process train basins:	Anoxic basin, aeration/microfiltration membrane (all basins concrete)
Membrane Type:	Hollow fiber, outside-in flow
Number of cassettes (@ 22 modules max. per cassette):	4 per process train (8 total)
Backpulse hypochlorite design dose:	5 mg/L
Hypochlorite solution strength:	5%

**Anoxic Basin:** Within the anoxic basin, the influent is mixed with mixed liquor in a tank with a dissolved oxygen equal to zero. The mixed liquor is pumped back to the anoxic basin from the immersed membrane section of the MBR. The introduction of new influent wastewater to the basin provides a substrate for the return activated sludge to respire and synthesize. The lack of dissolved oxygen in the basin facilitates nitrification and denitrification. Ammonia compounds are converted to nitrates by nitrifying bacteria. Denitrifying bacteria convert nitrates to nitrogen gas, which volatilize out of the basin. The proportion of recirculated mixed liquor to the volume of influent is approximately 6:1. The anoxic basin has a relatively small retention time compared to the aeration basin or the immersed membrane section, due to its smaller volume.

**Aeration Basins with Immersed Membranes:** The mixed liquor produced by the anoxic basin would flow by gravity through a short channel to the adjacent aeration basin. The aeration basin differs from the anoxic basin in that this basin contains dissolved oxygen, which is introduced to the tank through a series of fine bubble diffusers, connected by headers and pumped by a series of blowers. The dissolved oxygen is required to convert dissolved organic material into a filterable solid material. In this process, aerobic bacteria utilize the carbon in the wastewater for respiration and cell synthesis. The primary outcome result from this basin is an overall reduction in the biochemical oxygen demand (BOD), and the production of a filterable floc.

The microfiltration membranes are long, hollow, spaghetti-like fibers with a nominal pore size of between 0.1 – 0.4 microns. Each of the individual microfiltration membranes is bundled together into modules, and each module is approximately 6 inches in diameter and 5 feet tall. The modules are grouped into sets, called cassettes, which are immersed into the mixed liquor solution. Each of the membrane modules is attached to headers, which create a suction and force water (permeate) through the membrane into the hollow center and onwards to the disinfection process. The mixed liquor that is not forced through the membrane is recirculated back to the anoxic zone. A portion of this recirculated mixed liquor is wasted to sludge stabilization basins for disposal.

Each MBR train contains one permeate pump to force water through the membrane, and there is one standby permeate pump for the overall process that can draw from either train. These pumps can also pump permeate to the backpulse tanks, where water is stored in order to backwash the membrane. The permeate pumps also function as backpulse pumps, which

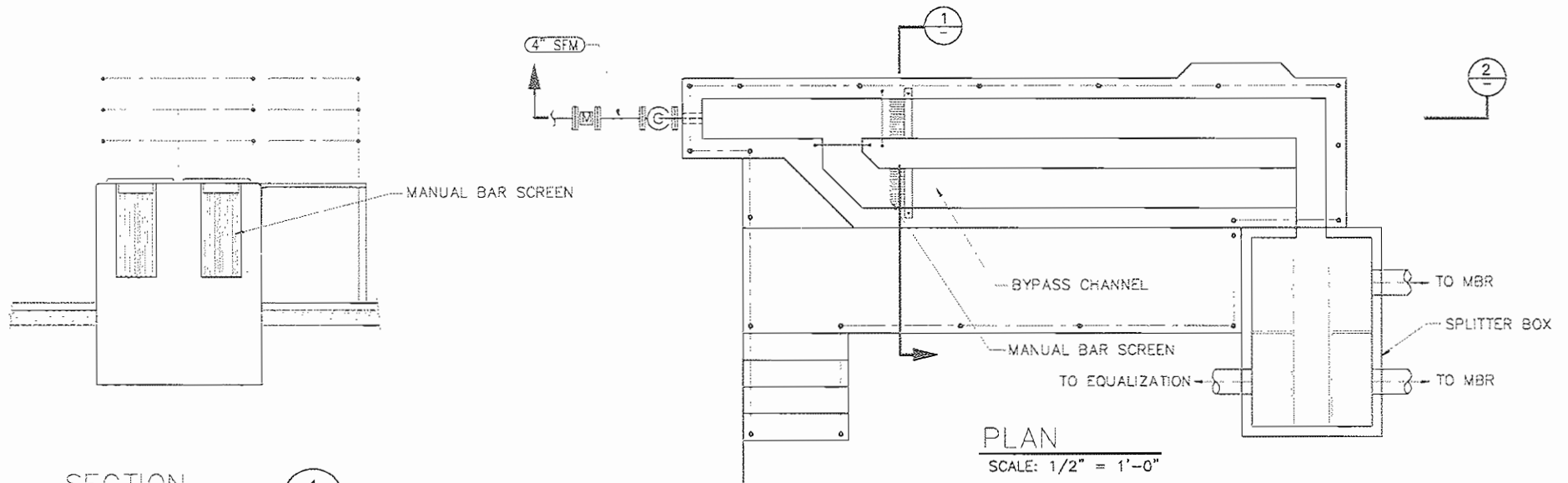

SECTION 1  
SCALE: 1/2" = 1'-0"

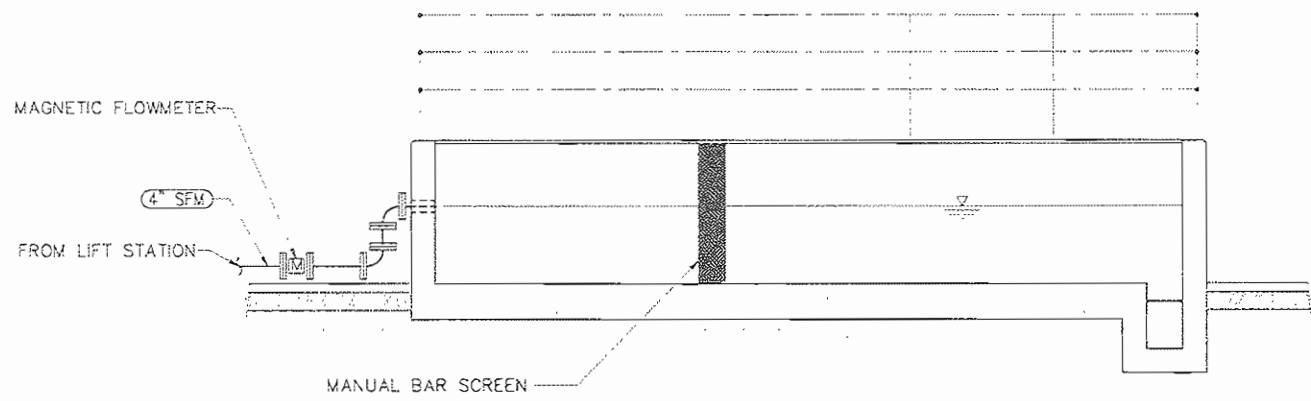

SECTION 2  
SCALE: 1/2" = 1'-0"

**FIGURE 6-2**  
**STATION CASINOS**  
**GRATON RANCHERIA HOTEL AND CASINO PROJECT**  
**TYPICAL HEADWORKS PLAN AND SECTION**

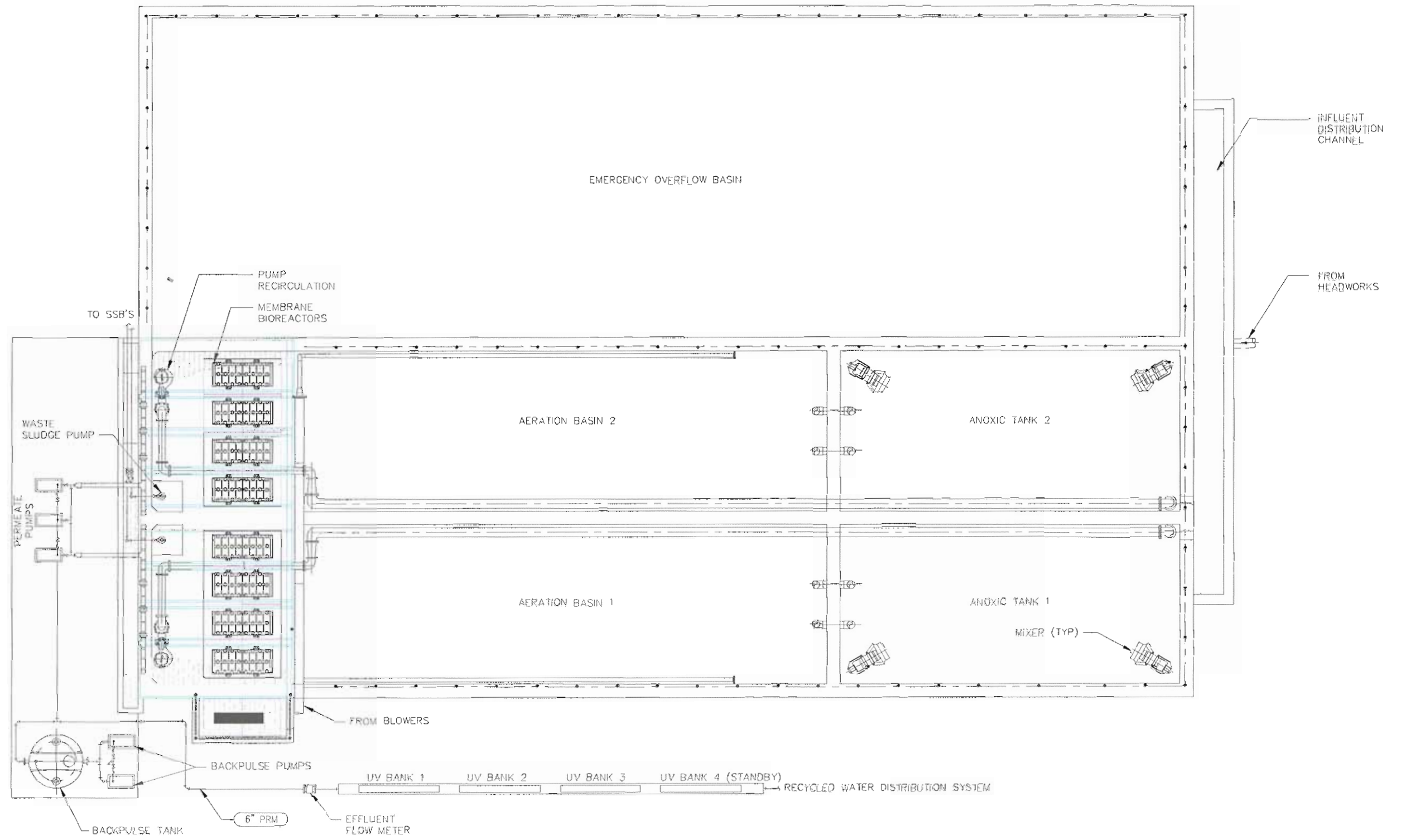

**PLAN**  
SCALE: 3/32" = 1'-0"

**FIGURE 6-3**  
**STATION CASINOS**  
**GRATON RANCHERIA HOTEL AND CASINO PROJECT**  
**TYPICAL WASTEWATER TREATMENT FACILITY PLAN**

C:\Compass\Projects\192\_05\_Station\_Casinos\_Solomon\_Plan\Locality\_Plan\Station\_Casinos\_Solomon\_Plan\_Vis\_E-3.dwg DATE: 11/27/08



pump permeate from the permeate tanks back to the membranes, and keeps solids from accumulating on the membrane surface. The membranes are typically backwashed every 15 minutes, and each backwash lasts about two minutes. The entire backwash process is controlled by a PLC, which operates automatic control valves and isolates the membranes from the permeate pumping process. Sodium hypochlorite and/or citric acid is typically injected into the backpulse flow to facilitate membrane cleaning, and prevent regrowth in the membrane modules.

**Other facilities:** A number of pumps, blowers, chemical storage, chemical metering, control, and electronic facilities are required in order to operate the MBR process. These are typically located in a building near the MBR process. It is also possible for an operations building to be constructed, which could house plant controls, the motor control center, blowers for the MBR process, maintenance facilities, a laboratory, and offices/space for staff. During design development, these facilities will be further defined. **Figure 6-4** shows the proposed electrical, controls, and operations building.

The expected volume required for equalization is 80,000 gallons. Further detail can be found in **Appendix C**. This will moderate the peak daily flows entering the WWTP. Emergency storage is also expected to be included with sufficient capacity for the average weekday flow. The equalization tank would consist of a concrete tank either at or below grade, of a to-be-determined volume and size.

### 6.2.3 UV Disinfection

Disinfection to meet discharge and reclamation virus and coliform water quality standards would be provided by constructing an ultraviolet (UV) disinfection system adjacent to the MBR. UV disinfection facilities are typically contained within a long, narrow steel channel tank, with banks of UV lamps situated in a laminar flowing channel. A weir would control the water level in the channel, ensuring that the lamps are always submerged. Each UV lamp emits a light with a specific wavelength that is capable of inactivating bacteria and virus, preventing them from reproducing. A proposed location for UV facilities is shown adjacent to the MBR tanks on **Figure 6-3**. **Table 6-4** shows a summary of the recommended UV Disinfection design criteria.

**Table 6-4: UV Disinfection Design Criteria**

Parameter	Value
Lamp location	In-line
Type of lamps	2020W medium pressure UV lamps
Transmittance	65% through quartz sleeve
Flow metering	Magnetic flow meter

### 6.2.4 Chlorine Disinfection

Though the UV facilities would be designed to disinfect the treated wastewater, they do not continue to disinfect the wastewater after it leaves the UV channel. In order to prevent regrowth of bacteria in the recycled water distribution system, sodium hypochlorite is typically added in small quantities. The introduction of this chemical creates a residual concentration of chlorine that persists in the recycled water, and ensures that it is safe to use after it leaves the

wastewater treatment facility. Typical recycled water distribution systems require at least a positive chlorine residual at the point of use, and the dosing of sodium hypochlorite will be adjusted to meet this goal. It is believed that a dose of between 2-3 mg/L for recycled water used for on-site irrigation, cooling, or toilet/urinal flushing would suffice. Chlorine would be dosed at a location downstream of the UV disinfection facilities, and before recycled water is pumped to the recycled water storage tank. Any water discharged to surface waters would be fully de-chlorinated prior to discharge.

Chlorine is a very common disinfectant in the treatment and disinfection of wastewater. Sodium hypochlorite is used throughout the wastewater industry for chlorine disinfection, and when used in accordance with that chemical's MSDS, is safe for use for this purpose.

### **6.3 Discharge Facilities**

If a discharge permit is obtained from the RWQCB, the preferred location for locating a discharge facility is on the main channel of the Laguna, just upstream of the Stony Point Road Bridge. Streamflow rates near the Wilfred site are highest in this location, which maximize the dilution of effluent discharged. However, there is no current discharge pipeline at this location. Should this site be chosen for the discharge facility, a new pipeline would need to be constructed for discharge to the Laguna.

A review of a map showing the existing storm drain inlets identified a number of inlets to the Bellevue-Wilfred Channel. These pipelines would allow effluent to be discharged within the tribal trust lands, flow off-site, and then enter the Bellevue-Wilfred Channel through an existing storm drain inlet. The preferred storm drain for discharge would be 54-inch inlet located approximately 1900 ft from the Rohnert Park Expressway. Though discharge directly to the Laguna would be preferred, external issues may require that an existing pipeline be utilized as the point of discharge. Additional information about the location, size, and design of the outfall will be developed after additional consultation with the RWQCB.

### **6.4 Operations and Maintenance**

This section contains a brief description of the expected operations and maintenance requirements for the facility. A detailed description of the operations and maintenance program will be prepared following completion of the wastewater treatment plant design. However, it is expected that the wastewater treatment plant would be operated and maintained similarly to the standards of other tertiary treatment plants in California.

To this effect, this wastewater plant will be staffed with operators who are qualified to operate the plant safely, effectively, and in compliance with all permit requirements and regulations. It is expected that the operators will have qualifications similar to those required by the State Water Resources Control Board Operator Certification Program. This program specifies that for tertiary level wastewater treatment plants with design capacities of 1.0 MGD or less, the chief plant operator must be at least a Grade III operator. Supervisors and Shift Supervisors must be at least a Grade II.





## 6.5 Recycled Water

This section discusses the recommended design criteria for the Project's recycled water facilities. The recommended on-site recycled water facilities include:

- Recycled Water Storage Tank
- Recycled Water Pump Station
- On-site Irrigation/Dual Plumbing Facilities
- Seasonal Storage Ponds
- Spray Fields

Each of the recycled water facilities is described in the following sections. The overall recycled facilities will be located based on the final design of the Project facilities. All of the recommended water supply facilities described in this Section are preliminary, and should be utilized for planning purposes only.

### 6.5.1 Storage Tank

The purpose of this tank would be to provide equalization storage for on-site recycled water use used by the Project for toilet flushing, on-site landscaping, spray field irrigation, and other uses. Should seasonal storage facilities be constructed, the water would also be pumped to the seasonal storage basins from this storage tank. If desired, recycled water could be utilized to supply water for fire protection, such as the sprinkler systems and fire hydrants.

A typical section for the tank is shown as **Figure 6-5**. The recycled water storage tank would be constructed near the wastewater treatment plant site. Since the Wilfred site is relatively flat, the tank would not maintain pressure in the recycled water distribution system. This storage tank would be similar to the potable water storage tank with respect to construction methods.

**Table 6-5: Recycled Water Storage Tank Design Criteria**

Parameter	Value
Approximate size	0.5 MG
Approximate diameter	60 feet
Approximate height	24 feet
Construction	Welded steel

### 6.5.2 Recycled Water Pump Station

Three separate recycled water pump stations are required for the recycled water facilities. All of the required pump sizes and configuration would be determined during design. However, the strategy described below assumes that seasonal storage is utilized, recycled water is produced and maximized on-site, and that the flows are similar to those identified in the project description for Alternative A in Section 2.

The first pump station would pump water from the wastewater treatment plant to the recycled water storage tank. This pump station is expected to be a low head pump station with a hydropneumatic tank that fills the recycled water tank to provide system storage.

The second pump station would pump water from the recycled water storage tank to the recycled water distribution system. This pump station would likely need to continuously operate, since there will be no system storage. There are no suitable locations at the Wilfred site for a recycled water storage tank at an elevation that would allow gravity to maintain distribution system pressure.

The third pump station would pump out of the seasonal storage ponds to the spray fields for irrigation. These pumps will operate seasonally, typically between April and October, and would be sized to convey the entire volume of recycled water stored in the seasonal storage ponds plus a portion of the daily summertime wastewater flows within a 5-day a week, 8 hours per day time period between March and October.

### **6.5.3 On-site Water Reuse Facilities**

This report assumes that the casino building will be dual-plumbed with both potable and recycled water. The primary uses of recycled water will be for toilet flushing, on-site landscape irrigation, and cooling water. The on-site recycled water reuse facilities will be designed to ensure that they comply with all DHS standards. The required on-site facilities will be identified upon completion of a site plan and preliminary engineering. The primary on-site design requirements include:

- Recycled water irrigation facilities marked in a purple color.
- Signage informing the public recycled water is used.
- Pipelines in separate trenches a minimum distance away from other water pipelines.
- Labeling of recycled water valves, boxes, and sprinkler heads.

Within the building, the interior plumbing system will have to be plumbed separately from the building's potable water system, and contain no cross connections. The dual plumbing piping systems must be distinctly marked and color-coded.

### **6.5.4 Seasonal Storage Ponds**

The proposed seasonal discharge strategy will rely heavily on spray fields for the summer application of recycled water that cannot be discharged off-site. Seasonal holding ponds, if required, would be constructed using semi-buried ponds and berms. The ponds would need to be lined with a relatively impermeable material such as clay or concrete to minimize percolation into the groundwater and are expected to be located outside of the 100-year flood plain.

### **6.5.5 Spray Field Irrigation System**

There is an existing network of recycled water conveyance pipes located on the proposed Wilfred site. Some of this piping may potentially be utilized to convey on-site recycled water for spray field disposal. It may be necessary to construct additional recycled water transmission piping from the treatment plant and seasonal storage reservoir to the spray fields, depending on site layout.

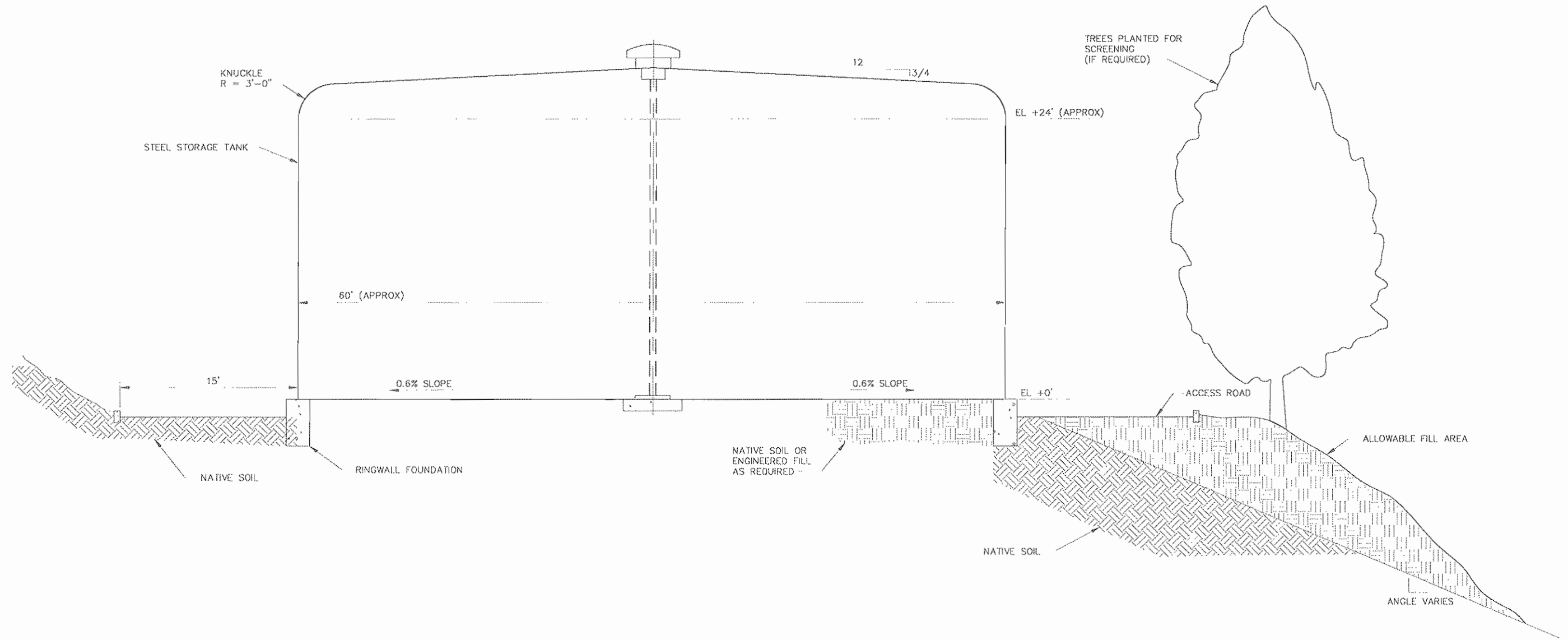

**ELEVATION**  
NTS

**FIGURE 6-5**  
STATION CASINOS  
GRATON RANCHERIA HOTEL AND CASINO PROJECT  
TYPICAL RECYCLED WATER STORAGE TANK

P:\COMPS\PROJECTS\STATION CASINOS\FIGURE 6-5.TIF 12/14/11 10:24 AM

The spray fields would be irrigated using traditional rows of impact head sprinklers mounted on wheels. The sprinklers would be moved within the spray field site as needed to ensure even application of recycled water and to minimize the piping infrastructure required.

## SECTION 7: RECOMMENDATIONS

This feasibility study report makes the following preliminary recommendations with respect to the proposed Project. This section identifies the recommendations for Alternative A, and is referred to as the Project, since the requirements for Alternative A either meet or exceed those for the other four alternatives.

### 7.1 Water Supply

1. The Project should drill two on-site water supply wells to a depth of approximately 600 feet. Each well should be capable of meeting the peak day Project water demands.
2. The wells should screen off the more shallow aquifers above approximately 200 feet.
3. The Project should plan on constructing the following water supply facilities:
  - Two on-site wells
  - Iron and Manganese water treatment plant
  - Steel water storage tank
  - Water distribution pump station

### 7.2 Wastewater Handling

1. The Project should explore opportunities to connect to the City's sanitary sewer collection system.
2. Should a City sanitary sewer connection not be available for any reason, the Project should construct an on-site wastewater treatment plant to treat an average weekend flow of 400,000 gpd.
3. The Project should maximize the on-site recycling of wastewater.
4. The Project should apply for a NPDES permit to discharge effluent to the Bellevue-Wilfred Channel.
5. Flow limitations for off-site discharged should be monitored with the existing USGS gauging station at the intersection of Stony Point Road and the Laguna.
6. The Project should prepare contingency plans for on-site disposal of wastewater in the event that the NPDES permit is delayed or denied.
7. The Project should plan on constructing the following wastewater handling facilities:
  - Immersed membrane bioreactor wastewater treatment plant with UV Disinfection & Chlorination
  - Recycled water storage tank
  - Recycled water distribution pump station
  - Seasonal storage ponds
  - Spray fields



## SECTION 8: REFERENCES

1. City of Rohnert Park, *Final Water Supply Assessment*, January 2005.
2. City of Rohnert Park, *Summary of Well Logs*, 2003.
3. City of Santa Rosa, *Incremental Recycled Water Program, Draft EIR*, 2003
4. Economic & Planning Systems Inc, *Northwest Specific Plan Market Analysis*, August 2004.
5. Geocon, Inc., *Draft Geologic and Geotechnical Feasibility Investigation*, 2003.
6. Geocon, Inc., *Project Geological Report*, 2003.
7. HydroScience Engineers, *NPDES Permit Application and Engineering Report for the Graton Rancheria Hotel and Casino Project*, 2004.
8. Komex, Inc. (Roseville, CA), *Draft Groundwater Study for the Proposed Graton Rancheria Casino and Hotel*, Prepared for AES, October 2005
9. Parsons, *Northwest Specific Plan Environmental Impact Report*, 2004.
10. Parsons, *Northwest Specific Plan, Southern Area ("Part B") Final Draft*, 2004
11. Personal communication, Darrin Jenkins, August 2005 telephone conversation.
12. Personal communication, Darrin Jenkins, November 2005 email.
13. Regional Water Quality Control Board, North Coast, *North Coast RWQCB Basin Plan*, June 2001 (last amended).
14. United States Geological Survey, *Daily Streamflow for the Nation USGS 11465680 LAGUNA DE SANTA ROSA AT STONY PT RD NR COTATI CA*, [http://nwis.waterdata.usgs.gov/nwis/discharge/?site\\_no=11465680&agency\\_cd=USGS](http://nwis.waterdata.usgs.gov/nwis/discharge/?site_no=11465680&agency_cd=USGS), 1998 – 2004.
15. Winzler and Kelly Consulting Engineers, *Draft Initial Study/Proposed Mitigated Negative Declaration for the Rohnert Park Sewer Interceptor/Outfall Project*, December 2004.

## APPENDIX A

Laguna de Santa Rosa Water Quality Results

Appendix A: Laguna de Santa Rosa Water Quality Results - January-May 2004  
 General Water Chemistry

ANALYTE	Method	01/05/04	02/06/04	03/04/04	04/07/04	05/05/04	05/20/04	Average <sup>1</sup>
General Water Chemistry								
pH	EPA 150.1	7.06	7.22	7.42	7.37	7.26	7.30	7.27
TDS (mg/L)	EPA 160.1	260	180	1100	360	430	370	450
TSS (mg/L)	EPA 160.2	ND	ND	17	ND	30	260	56
Specific Cond. (umho/cm)	SM 2510	410	380	440	680	760	640	552
Hardness (mg CaCO <sub>3</sub> /L)	EPA 130.2	160	140	240	270	270	240	220
Turbidity (NTU)	EPA 180.1	9.4	19	8.8	4.8	24	89	25.8
Nitrate (mg-N/L)	EPA 300.0	2.3	1	1	0.39	ND	ND	0.82
Nitrite (mg-N/L)	EPA 300.0	0.07	0.076	ND	ND	NA	ND	0.06
Ammonia (mg-N/L)	EPA 350.3	0.38	0.22	0.38	0.15	0.099	0.42	0.27
TKN (mg/L)	EPA 351.2	3.00	4.00	1.40	0.82	0.83	1.60	1.94
Organic N (mg-N/L)	calc <sup>2</sup>	2.62	3.78	1.02	0.67	0.73	1.18	1.67
Total N (mg-N/L)	calc <sup>3</sup>	5.37	5.08	2.45	1.26	0.98	1.75	2.81
Total Phosphorous (mg-P/L)	EPA 365.3	0.49	0.52	0.60	0.32	0.51	0.50	0.49
Orthophosphate (mg-P/L)	EPA 365.3	0.34	0.48	0.56	0.29	0.45	0.37	0.42
Alkalinity (mg CaCO <sub>3</sub> /L)	EPA 310.1	120	130	160	260	280	260	202
Carbonate Alkalinity (mg CaCO <sub>3</sub> /L)	EPA 310.1	ND	ND	ND	ND	ND	ND	ND
Bicarbonate Alkalinity (mg CaCO <sub>3</sub> /L)	EPA 310.1	120	130	160	260	280	260	202
Hydroxide Alkalinity (mg CaCO <sub>3</sub> /L)	EPA 310.1	ND	ND	ND	ND	ND	ND	ND
Total Coliform (MPN/100 mL)	SM 9221	900	1600	220	900	240	1600	910
Fecal Coliform (MPN/100mL)	SM 9221	900	1600	300	80	240	1600	787
Oil and Grease (mg/L)	EPA 413.1	ND	ND	ND	ND	ND	ND	ND

ND = Not Detected

NA = Not Available

<sup>1</sup> Non-detect (ND) results were assumed to be present at the Reporting Limit for the calculation of the average value

<sup>2</sup> Organic N = TKN minus ammonia-N

<sup>3</sup> Total N = TKN plus nitrate-N plus nitrite-N



## **APPENDIX B**

Spray Field and Seasonal Storage Pond Sizing Calculations

#### Assumptions:

- A one-year analysis was conducted based on the assumption that the reservoir would be sized to be empty at the end of the September during a 100-year event.
- If surface water discharge is permitted, it was assumed that any water accumulated in the reservoir during the summer could be discharged over the course of the winter at rates limited to those allowed by the NPDES permit. It was also assumed that any precipitation into the reservoir would be discharged.
- To account for the 100-year event, monthly rainfall averages were increased by a factor of 1.83. These increased values were used for both precipitation into the storage ponds and in calculating the irrigation demands.
- Evaporation from the Seasonal Storage Ponds was also reduced by 20% from December to April to account for reduced evaporation in the 100-year event.
- The reservoir area, evaporative surface, and area receiving precipitation were all assumed to be identical and uniform regardless of depth.
- Precipitation data was an average of 1990 to 2003 CIMIS data
- ETO values were an average of 1990 to 2003 CIMIS data
- The Crop Coefficient was assumed to be 0.8, consistent with cool turf grass species.
- Pan Evaporation values were taken from Table 1 of "Vegetative Water Use in California", 1974. Bulletin No. 113-3. Sacramento. Department of Water Resources. April, 1975
- The Pan Evaporation Coefficient for open water was assumed to be 0.75
- The loss rate was assumed to be 1.1.
- The irrigation efficiency was assumed to vary throughout the year from 0.6 in the summer to 0.95 in the winter.



**TABLE 2**  
**Spray Field/Seasonal Storage Sizing**  
 Rohnert Park Wastewater Treatment Plant  
 Alternative A Seasonal Discharge

100-YR MODIFIERS		WWTP INFLUENT FLOWS				STORAGE RESERVOIR						DISPOSAL OPTIONS				
100-year Return Ratio	1.83 unitless	Influent Flow	260,000 gpd			Reservoir Watershed Area						Capacity (gpd)		Area (acres)		
100-YR modifier - Pan Evaporation	0.8 unitless	Annual Influent Flow	94.9 mg/yr									2.20 acres		Leachfields	0	0
100-YR I/I Volume	0.0 %	Pan Evap Coefficient	0.75 unitless									Sprayfields	0	53.46095977	Landscaping	0
		<b>100-YEAR ANNUAL PRECIPITATION RETURN PERIOD</b>														
	<b>Units</b>	<b>October</b>	<b>November</b>	<b>December</b>	<b>January</b>	<b>February</b>	<b>March</b>	<b>April</b>	<b>May</b>	<b>June</b>	<b>July</b>	<b>August</b>	<b>September</b>	<b>Season Total</b>	<b>AVG PREC. Season Total</b>	
<b>Climate Inputs</b>																
Precipitation (Average)	in	1.56	3.89	6.40	7.19	6.57	4.15	2.04	1.58	1.46	0.56	0.75	0.36	36.49	36.49	
Precipitation (100-YR)	in	2.84	7.10	11.57	13.12	11.99	7.57	3.73	2.88	2.67	1.01	1.36	0.66	66.60	66.60	
Pan Evaporation	in	3.60	1.60	1.00	1.20	1.60	3.10	4.40	6.40	7.60	9.10	8.00	6.00	53.60	53.60	
Effective Lake Evaporation	in	2.70	1.20	0.75	0.90	1.20	2.33	3.30	4.80	5.70	6.83	6.00	4.50	40.20	40.20	
Lake Evap - 100YR Effective	in	2.70	1.20	0.60	0.72	0.96	1.86	2.64	4.80	5.70	6.83	6.00	4.50	38.51	38.51	
Percolation	in	0	0	0	0	0	0	0	0	0	0	0	0	0.00	0.00	
<b>Rohnert Park WWTP</b>																
# Days in Month	days	31	30	31	31	28	31	30	31	30	31	31	30	365	365	
Wastewater Influent	MG	8.06	0.00	0.00	0.00	0.00	0.00	7.80	8.06	7.80	8.06	8.06	7.80	55.64	55.64	
Wastewater Influent	ac-ft	24.74	0.00	0.00	0.00	0.00	0.00	23.94	24.74	23.94	24.74	24.74	23.94	170.76	170.76	
WW Influent + 100-YR I/I	ac-ft	24.74	0.00	0.00	0.00	0.00	0.00	23.94	24.74	23.94	24.74	24.74	23.94	170.76	170.76	
Site Run-off/Precip/Evap	ac-ft	NA	NA	NA	NA	NA	NA	NA	NA	NA	NA	NA	NA	0.00	0.00	
<b>Storage Reservoir Contribution</b>																
Reservoir Vol	ac-ft	0.00	21.71	21.71	21.71	21.71	21.71	0.00	18.92	24.66	23.48	11.15	4.68	NA	NA	
Reservoir Depth	ft	0.0	9.9	9.9	9.9	9.9	9.9	0.0	8.6	11.2	10.7	5.1	2.1	NA	NA	
Reservoir Surface Area	acre	2.2	0.0	0.0	0.0	0.0	0.0	2.2	2.2	2.2	2.2	2.2	2.2	NA	NA	
Reservoir Precip (direct)	ac-ft	0.52	0.00	0.00	0.00	0.00	0.00	0.68	0.53	0.49	0.19	0.25	0.12	2.78	6.70	
Reservoir Evaporation	ac-ft	-0.50	0.00	0.00	0.00	0.00	0.00	-0.48	-0.88	-1.05	-1.25	-1.10	-0.83	-6.08	-8.04	
<b>Disposal</b>																
<b>Leachfields</b>																
Percent Used	%	0	0	0	0	0	0	0	0	0	0	0	0	NA	NA	
Total Disposed	ac-ft	0.0	0.0	0.0	0.0	0.0	0.0	0.0	0.0	0.0	0.0	0.0	0.0	0.00	0.00	
<b>Spray Fields</b>																
Percent Used	%	0	0	0	0	0	0	0	0	0	0	0	0	NA	NA	
Total Disposed	ac-ft	0.0	0.0	0.0	0.0	0.0	0.0	0.0	0.0	0.0	0.0	0.0	0.0	0.00	0.00	
<b>Landscaping</b>																
Total Disposed	ac-ft	-3.1	0.0	0.0	0.0	0.0	0.0	-5.2	-18.6	-24.6	-36.0	-30.4	-30.4	-148.19	-141.26	
<b>Effluent Storage</b>																
Beginning Water Volume in Res	ac-ft	0.0	21.7	21.7	21.7	21.7	21.7	0.0	18.9	24.7	23.5	11.2	4.7	NA	NA	
Change in Water Volume	ac-ft	21.7	0.0	0.0	0.0	0.0	0.0	18.9	5.7	-1.2	-12.3	-6.5	-7.1	19.27	28.16	
Final Water Volume in Res	MG	7.1	7.1	7.1	7.1	7.1	0.0	6.2	8.0	7.6	3.6	1.5	0.0	6.3	9.2	
Final Water Volume in Res	ac-ft	21.7	21.7	21.7	21.7	21.7	0.0	18.9	24.7	23.5	11.2	4.7	0.0	NA	NA	

Areas	acres
Grass	96.00
EGS	0.0
EGT	0.0
Landscape Irrigation	53.5
<b>Total</b>	<b>53.5</b>

Rainfall efficiency: 0.75  
 leachate factor: 1.10  
 Irrigation efficiency: 0.85

EGS= evergreen shrubbery  
 EGT = evergreen tree

Days	Rainfall (inches)	Month	Normal ET <sub>0</sub> (inches)	Grass				EGS				EGT				Total Demand (acre-feet)
				k	ET (inches)	Unit Demand		k	ET (inches)	Unit Demand		k	ET (inches)	Unit Demand		
						(inches)	(acre-feet)			(inches)	(acre-feet)			(inches)	(acre-feet)	
30	3.88	Nov	1.51	0.8	1.21	0.00	0.00	1.15	1.74	0.00	0.00	1.20	1.81	0.00	0.00	0.00
31	5.40	Dec	1.01	0.8	0.81	0.00	0.00	1.15	1.16	0.00	0.00	1.20	1.21	0.00	0.00	0.00
31	7.18	Jan	1.02	0.8	0.82	0.00	0.00	1.15	1.17	0.00	0.00	1.20	1.22	0.00	0.00	0.00
28	6.57	Feb	1.61	0.8	1.29	0.00	0.00	1.15	1.85	0.00	0.00	1.20	1.93	0.00	0.00	0.00
31	4.15	Mar	3.12	0.8	2.50	0.00	0.00	1.15	3.59	0.62	0.00	1.20	3.74	0.82	0.00	0.00
30	2.24	Apr	4.36	0.8	3.49	2.53	20.25	1.15	5.01	4.51	0.00	1.20	5.23	4.79	0.00	20.25
31	1.88	May	5.55	0.8	4.44	4.22	33.73	1.15	6.38	6.73	0.00	1.20	6.66	7.09	0.00	33.73
30	1.46	Jun	6.26	0.8	5.01	5.06	40.50	1.15	7.20	7.90	0.00	1.20	7.51	8.30	0.00	40.50
31	0.56	Jul	6.46	0.8	5.17	6.15	49.19	1.15	7.43	9.07	0.00	1.20	7.75	9.49	0.00	49.19
31	0.75	Aug	5.92	0.8	4.74	5.41	43.25	1.15	6.81	8.09	0.00	1.20	7.10	8.47	0.00	43.25
30	5.36	Sep	4.50	0.8	3.60	4.31	34.48	1.15	5.18	6.35	0.00	1.20	5.40	6.64	0.00	34.48
31	1.56	Oct	3.25	0.8	2.60	1.86	14.82	1.15	3.74	3.32	0.00	1.20	3.90	3.54	0.00	14.82
##	3.04 Average		3.71		2.97	2.46	19.68	1.15	4.27	3.88	0.00	1.20	4.46	4.09	0.00	19.68
##	36.49 Total		44.57		35.66	29.53	236.21	13.80	51.26	46.58	0.00	14.40	53.48	49.13	0.00	236.21

Month	Normal ET <sub>0</sub> (inches)	k	ET (inches)	Irrigation Efficiency	Unit Demand	Demand
					(inches)	(acre-feet)
Nov	1.51	0.8	1.21	0.95	0.00	0.00
Dec	1.01	0.8	0.81	0.95	0.00	0.00
Jan	1.02	0.8	0.82	0.95	0.00	0.00
Feb	1.61	0.8	1.29	0.95	0.00	0.00
Mar	3.12	0.8	2.50	0.70	0.00	0.00
Apr	4.36	0.8	3.49	0.65	1.17	5.22
May	5.55	0.8	4.44	0.60	4.18	18.64
Jun	6.26	0.8	5.01	0.60	5.51	24.57
Jul	6.46	0.8	5.17	0.60	8.08	36.09
Aug	5.92	0.8	4.74	0.60	6.81	30.35
Sep	4.50	0.8	3.60	0.65	5.26	23.43
Oct	3.25	0.8	2.60	0.75	0.89	3.06
	3.71	0.80	2.97		2.64	11.77
	44.57	9.60	35.66		31.71	141.26

Weighted Average of the GRASS, EGS, and EGT together in this one  
 Because could variate the landscaping irrigation per month

**TABLE 2**  
**Spray Field/Seasonal Storage Sizing**  
 Rohnert Park Wastewater Treatment Plant  
 Alternative A No Seasonal Discharge

100-YR MODIFIERS		WWTP INFLUENT FLOWS		STORAGE RESERVOIR		DISPOSAL OPTIONS	
100-year Return Ratio	1.83 unitless	Influent Flow	280,000 gpd	Reservoir Watershed Area	12.70 acres	Capacity (gpd)	Area (acres)
100-YR modifier - Pan Evaporation	0.8 unitless	Annual Influent Flow	94.9 mg/yr	Leachfields	0	0	0
100-YR I/I Volume	0.0 %	Pan Evap Coefficient	0.75 unitless	Sprayfields	5,000	118.0520184	40.20
				Landscaping	0	0	0

	Units	100-YEAR ANNUAL PRECIPITATION RETURN PERIOD												AVG PREC.	
		Octbr	Novembr	Decembr	Janary	Febary	March	April	May	de	Uy	Agst	Septembr		Season Total
<b>Climate Inputs</b>															
Precipitation (Average)	in	1.56	3.89	6.40	7.19	6.57	4.15	2.04	1.58	1.46	0.56	0.75	0.36	36.49	36.49
Precipitation (100-YR)	in	2.84	7.10	11.67	13.12	11.99	7.57	3.73	2.88	2.67	1.01	1.38	0.66	66.60	66.60
Pan Evaporation	in	3.60	1.60	1.00	1.20	1.60	3.10	4.40	6.40	7.60	9.10	8.00	6.00	53.60	53.60
Effective Lake Evaporation	in	2.70	1.20	0.75	0.90	1.20	2.33	3.30	4.80	5.70	6.83	6.00	4.50	40.20	40.20
Lake Evap - 100YR Effective	in	2.70	1.20	0.60	0.72	0.96	1.86	2.64	4.80	5.70	6.83	6.00	4.50	38.51	38.51
<b>Rohnert Park WWTP</b>															
# Days in Month	days	31	30	31	31	28	31	30	31	30	31	31	30	365	365
Wastewater Influent	MG	8.06	7.80	8.06	8.06	7.35	8.06	7.80	8.06	7.80	8.06	8.06	7.80	94.97	94.97
Wastewater Influent	ac-ft	24.74	23.94	24.74	24.74	22.54	24.74	23.94	24.74	23.94	24.74	24.74	23.94	291.46	291.46
WW Influent + 100-YR I/I	ac-ft	24.74	23.94	24.74	24.74	22.54	24.74	23.94	24.74	23.94	24.74	24.74	23.94	291.46	291.46
<b>Storage Reservoir Contribution</b>															
Reservoir Vol	ac-ft	0.00	18.14	48.33	84.78	122.64	156.85	187.64	201.19	182.74	149.22	88.32	41.12	NA	NA
Reservoir Depth	ft	0.0	1.4	3.8	5.7	9.7	12.4	14.8	15.8	14.4	11.7	7.0	3.2	NA	NA
Reservoir Surface Area	acre	12.7	12.7	12.7	12.7	12.7	12.7	12.7	12.7	12.7	12.7	12.7	12.7	NA	NA
Reservoir Precip (direct)	ac-ft	3.01	7.52	12.35	13.88	12.68	8.02	3.94	3.04	2.82	1.07	1.44	0.70	70.49	9.85
Reservoir Evaporation	ac-ft	-2.86	-1.27	-0.64	-0.76	-1.02	-1.97	-2.79	-5.08	-6.03	-7.22	-6.35	-4.76	-40.75	-11.58
<b>Disposal</b>															
<u>Leachfields</u>															
Percent Used	%	0	0	0	0	0	0	0	0	0	0	0	0	NA	NA
Total Disposed	ac-ft	0.0	0.0	0.0	0.0	0.0	0.0	0.0	0.0	0.0	0.0	0.0	0.0	0.00	0.00
<u>Spray Fields</u>															
Percent Used	%	0	0	0	0	0	0	0	0	0	0	0	0	NA	NA
Total Disposed	ac-ft	0.0	0.0	0.0	0.0	0.0	0.0	0.0	0.0	0.0	0.0	0.0	0.0	0.00	-3.98
<u>Landscaping</u>															
Total Disposed	ac-ft	-6.7	0.0	0.0	0.0	0.0	0.0	-11.5	-41.2	-54.2	-79.5	-67.0	-67.0	-327.23	-311.93
<b>Effluent Storage</b>															
Beginning Water Volume in Res	ac-ft	0.0	18.1	48.3	84.8	122.6	156.9	187.6	201.2	182.7	149.2	88.3	41.1	NA	NA
Change in Water Volume	ac-ft	18.1	30.2	36.5	37.9	34.2	30.8	13.6	-18.5	-33.5	-60.9	-47.2	-47.2	-6.03	-26.18
Final Water Volume in Res	MG	5.9	15.7	27.6	40.0	51.1	61.1	65.6	59.5	48.6	28.8	13.4	0.0	-2.0	-8.5
Final Water Volume in Res	ac-ft	18.1	48.3	84.8	122.6	156.9	187.6	212	182.7	149.2	88.3	41.1	0.0	NA	NA

Areas	acres
Grass	96.00
EGS	0.0
EGT	0.0
Landscape Irrigation	118.1
<b>Total</b>	<b>118.1</b>

Rainfall efficiency: 0.75  
 leachate factor: 1.10  
 Irrigation efficiency: k: 0.80 for cool turf grasses

EGS= evergreen shrubbery  
 EGT = evergreen tree

Days	Rainfall (inches)	Month	Normal ET <sub>0</sub> (inches)	Grass				EGS				EGT				Total Demand (acre-feet)
				k	ET (inches)	Unit Demand (inches)	Demand (acre-feet)	k	ET (inches)	Unit Demand (inches)	Demand (acre-feet)	k	ET (inches)	Unit Demand (inches)	Demand (acre-feet)	
30	3.29	Nov	1.51	0.8	1.21	0.00	0.00	1.15	1.74	0.00	0.00	1.20	1.81	0.00	0.00	0.00
31	3.45	Dec	1.01	0.8	0.81	0.00	0.00	1.15	1.16	0.00	0.00	1.20	1.21	0.00	0.00	0.00
31	7.19	Jan	1.02	0.8	0.82	0.00	0.00	1.15	1.17	0.00	0.00	1.20	1.22	0.00	0.00	0.00
28	6.57	Feb	1.81	0.8	1.29	0.00	0.00	1.15	1.85	0.00	0.00	1.20	1.93	0.00	0.00	0.00
31	4.15	Mar	3.12	0.8	2.50	0.00	0.00	1.15	3.59	#DIV/0!	#DIV/0!	1.20	3.74	#DIV/0!	#DIV/0!	#DIV/0!
30	2.04	Apr	4.36	0.8	3.49	#DIV/0!	#DIV/0!	1.15	5.01	#DIV/0!	#DIV/0!	1.20	5.23	#DIV/0!	#DIV/0!	#DIV/0!
31	7.36	May	5.55	0.8	4.44	#DIV/0!	#DIV/0!	1.15	6.38	#DIV/0!	#DIV/0!	1.20	6.66	#DIV/0!	#DIV/0!	#DIV/0!
30	1.46	Jun	6.26	0.8	5.01	#DIV/0!	#DIV/0!	1.15	7.20	#DIV/0!	#DIV/0!	1.20	7.51	#DIV/0!	#DIV/0!	#DIV/0!
31	0.23	Jul	6.46	0.8	5.17	#DIV/0!	#DIV/0!	1.15	7.43	#DIV/0!	#DIV/0!	1.20	7.75	#DIV/0!	#DIV/0!	#DIV/0!
31	0.25	Aug	5.92	0.8	4.74	#DIV/0!	#DIV/0!	1.15	6.81	#DIV/0!	#DIV/0!	1.20	7.10	#DIV/0!	#DIV/0!	#DIV/0!
30	0.35	Sep	4.50	0.8	3.60	#DIV/0!	#DIV/0!	1.15	5.18	#DIV/0!	#DIV/0!	1.20	5.40	#DIV/0!	#DIV/0!	#DIV/0!
31	1.56	Oct	3.25	0.8	2.60	#DIV/0!	#DIV/0!	1.15	3.74	#DIV/0!	#DIV/0!	1.20	3.90	#DIV/0!	#DIV/0!	#DIV/0!
##	3.04	Average	3.71		2.97	#DIV/0!	#DIV/0!	1.15	4.27	#DIV/0!	#DIV/0!	1.20	4.46	#DIV/0!	#DIV/0!	#DIV/0!
##	36.49	Total	44.57		35.66	#DIV/0!	#DIV/0!	13.80	51.26	#DIV/0!	#DIV/0!	14.40	53.48	#DIV/0!	#DIV/0!	#DIV/0!

Month	Normal ET <sub>0</sub> (inches)	Landscape Irrigation				
		k	ET (inches)	Irrigation Efficiency	Unit Demand (inches)	Demand (acre-feet)
Nov	1.51	0.80	1.21	0.95	0.00	0.00
Dec	1.01	0.80	0.81	0.95	0.00	0.00
Jan	1.02	0.80	0.82	0.95	0.00	0.00
Feb	1.61	0.80	1.29	0.95	0.00	0.00
Mar	3.12	0.80	2.50	0.70	0.00	0.00
Apr	4.36	0.80	3.49	0.65	1.17	11.53
May	5.55	0.80	4.44	0.60	4.18	41.16
Jun	6.26	0.80	5.01	0.60	5.51	54.24
Jul	6.46	0.80	5.17	0.60	8.08	79.49
Aug	5.92	0.80	4.74	0.60	6.81	67.03
Sep	4.50	0.80	3.60	0.65	5.26	51.73
Oct	3.25	0.80	2.60	0.75	0.69	6.75
	3.71	0.80	2.97		2.64	25.99
	44.57	9.60	35.66		31.71	311.93

Weighted Average of the GRASS, EGS, and EGT together in this one  
 Because could variate the landscaping irrigation per month

**TABLE 2**  
**Spray Field/Seasonal Storage Sizing**  
 Rohnert Park Wastewater Treatment Plant  
 Alternative D Seasonal Discharge

<b>100-YR MODIFIERS</b>		<b>WWTP INFLUENT FLOWS</b>				<b>STORAGE RESERVOIR</b>				<b>DISPOSAL OPTIONS</b>						
100-year Return Ratio	1.83 unitless	Influent Flow	180,000 gpd			Reservoir Watershed Area				Capacity (gpd)		Area (acres)				
100-YR modifier - Pan Evaporation	0.8 unitless	Annual Influent Flow	65.7 mg/yr			1.60 acres				Leachfields	0	0				
100-YR I/I Volume	0.0 %	Pan Evap Coefficient	0.75 unitless							Sprayfields	0	36.3478202				
										Landscaping	0	0				
			<b>100-YEAR ANNUAL PRECIPITATION RETURN PERIOD</b>													
	<b>Units</b>	<b>October</b>	<b>November</b>	<b>December</b>	<b>January</b>	<b>February</b>	<b>March</b>	<b>April</b>	<b>May</b>	<b>June</b>	<b>July</b>	<b>August</b>	<b>September</b>	<b>Season Total</b>	<b>AVG PREC. Season Total</b>	
<b>Climate Inputs</b>																
Precipitation (Average)	in	1.56	3.89	6.40	7.19	6.57	4.15	2.04	1.58	1.46	0.56	0.75	0.36	36.49	36.49	
Precipitation (100-YR)	in	2.84	7.10	11.67	13.12	11.99	7.57	3.73	2.88	2.67	1.01	1.36	0.66	66.60	66.60	
Pan Evaporation	in	3.60	1.60	1.00	1.20	1.60	3.10	4.40	6.40	7.60	9.10	6.00	6.00	53.60	53.60	
Effective Lake Evaporation	in	2.70	1.20	0.75	0.90	1.20	2.33	3.30	4.80	5.70	6.83	6.00	4.50	40.20	40.20	
Lake Evap - 100YR Effective	in	2.70	1.20	0.60	0.72	0.96	1.86	2.64	4.80	5.70	6.83	6.00	4.50	38.51	38.51	
Percolation	in	0	0	0	0	0	0	0	0	0	0	0	0	0.00	0.00	
<b>Rohnert Park WWTP</b>																
# Days in Month	days	31	30	31	31	28	31	30	31	30	31	31	30	365	365	
Wastewater Influent	MG	5.58	0.00	0.00	0.00	0.00	0.00	5.40	5.58	5.40	5.58	5.58	5.40	38.52	38.52	
Wastewater Influent	ac-ft	17.13	0.00	0.00	0.00	0.00	0.00	16.57	17.13	16.57	17.13	17.13	16.57	118.22	118.22	
WW Influent + 100-YR I/I	ac-ft	17.13	0.00	0.00	0.00	0.00	0.00	16.57	17.13	16.57	17.13	17.13	16.57	118.22	118.22	
Site Run-off/Precip/Evap	ac-ft	NA	NA	NA	NA	NA	NA	NA	NA	NA	NA	NA	NA	0.00	0.00	
<b>Storage Reservoir Contribution</b>																
Reservoir Vol	ac-ft	0.00	15.07	0.00	0.00	0.00	0.00	0.00	13.17	17.36	16.83	8.71	4.58	NA	NA	
Reservoir Depth	ft	0.0	9.4	0.0	0.0	0.0	0.0	0.0	8.2	10.9	10.5	5.4	2.9	NA	NA	
Reservoir Surface Area	acre	1.6	0.0	0.0	0.0	0.0	0.0	1.6	1.6	1.6	1.6	1.6	1.6	NA	NA	
Reservoir Precip (direct)	ac-ft	0.38	0.00	0.00	0.00	0.00	0.00	0.50	0.38	0.36	0.14	0.18	0.09	2.02	6.20	
Reservoir Evaporation	ac-ft	-0.36	0.00	0.00	0.00	0.00	0.00	-0.35	-0.64	-0.76	-0.91	-0.80	-0.60	-4.42	-7.34	
<b>Disposal</b>																
<b>Leachfields</b>																
Percent Used	%	0	0	0	0	0	0	0	0	0	0	0	0	NA	NA	
Total Disposed	ac-ft	0.0	0.0	0.0	0.0	0.0	0.0	0.0	0.0	0.0	0.0	0.0	0.0	0.00	0.00	
<b>Spray Fields</b>																
Percent Used	%	0	0	0	0	0	0	0	0	0	0	0	0	NA	NA	
Total Disposed	ac-ft	0.0	0.0	0.0	0.0	0.0	0.0	0.0	0.0	0.0	0.0	0.0	0.0	0.00	0.00	
<b>Landscaping</b>																
Total Disposed	ac-ft	-2.1	0.0	0.0	0.0	0.0	0.0	-3.6	-12.7	-16.7	-24.5	-20.6	-20.6	-100.75	-96.04	
<b>Effluent Storage</b>																
Beginning Water Volume in Res	ac-ft	0.0	15.1	0.0	0.0	0.0	0.0	0.0	13.2	17.4	16.8	8.7	4.6	NA	NA	
Change in Water Volume	ac-ft	15.1	0.0	0.0	0.0	0.0	0.0	13.2	4.2	-0.5	-8.1	-4.1	-4.6	15.07	21.04	
Final Water Volume in Res	MG	4.9	0.0	0.0	0.0	0.0	0.0	4.3	5.7	5.5	2.8	1.5	0.0	4.9	6.9	
Final Water Volume in Res	ac-ft	15.1	0.0	0.0	0.0	0.0	0.0	13.2	17.4	16.8	8.7	4.6	0.0	NA	NA	

Areas	acres
Grass	96.00
EGS	0.0
EGT	0.0
Landscape Irrigation	36.3
<b>Total</b>	<b>36.3</b>

Rainfall efficiency: 0.75  
 leachate factor: 1.10  
 Irrigation efficiency: 0.85

EGS= evergreen shrubbery  
 EGT = evergreen tree

Days	Rainfall (inches)	Month	Normal ET <sub>0</sub> (inches)	Grass				EGS				EGT				Total Demand (acre-feet)
				k	ET (inches)	Unit Demand (inches)	Demand (acre-feet)	k	ET (inches)	Unit Demand (inches)	Demand (acre-feet)	k	ET (inches)	Unit Demand (inches)	Demand (acre-feet)	
30	5.33	Nov	1.51	0.8	1.21	0.00	0.00	1.15	1.74	0.00	0.00	1.20	1.81	0.00	0.00	0.00
31	5.40	Dec	1.01	0.8	0.81	0.00	0.00	1.15	1.16	0.00	0.00	1.20	1.21	0.00	0.00	0.00
31	7.18	Jan	1.02	0.8	0.82	0.00	0.00	1.15	1.17	0.00	0.00	1.20	1.22	0.00	0.00	0.00
28	8.57	Feb	1.61	0.8	1.29	0.00	0.00	1.15	1.85	0.00	0.00	1.20	1.93	0.00	0.00	0.00
31	4.15	Mar	3.12	0.8	2.50	0.00	0.00	1.15	3.59	0.62	0.00	1.20	3.74	0.82	0.00	0.00
30	2.04	Apr	4.36	0.8	3.49	2.53	20.25	1.15	5.01	4.51	0.00	1.20	5.23	4.79	0.00	20.25
31	1.58	May	5.55	0.8	4.44	4.22	33.73	1.15	6.38	6.73	0.00	1.20	6.66	7.09	0.00	33.73
30	1.46	Jun	6.26	0.8	5.01	5.06	40.50	1.15	7.20	7.90	0.00	1.20	7.51	8.30	0.00	40.50
31	0.80	Jul	6.46	0.8	5.17	6.15	49.19	1.15	7.43	9.07	0.00	1.20	7.75	9.49	0.00	49.19
31	0.75	Aug	5.92	0.8	4.74	5.41	43.25	1.15	6.81	8.09	0.00	1.20	7.10	8.47	0.00	43.25
30	0.36	Sep	4.50	0.8	3.60	4.31	34.48	1.15	5.18	6.35	0.00	1.20	5.40	6.64	0.00	34.48
31	1.58	Oct	3.25	0.8	2.60	1.85	14.82	1.15	3.74	3.32	0.00	1.20	3.90	3.54	0.00	14.82
##	3.04 Average		3.71		2.97	2.46	19.68	1.15	4.27	3.88	0.00	1.20	4.46	4.09	0.00	19.68
##	36.49 Total		44.57		35.66	29.53	236.21	13.80	51.26	46.58	0.00	14.40	53.48	49.13	0.00	236.21

Month	Normal ET <sub>0</sub> (inches)	Landscape Irrigation				
		k	ET (inches)	Irrigation Efficiency	Unit Demand (inches)	Demand (acre-feet)
Nov	1.51	0.8	1.21	0.95	0.00	0.00
Dec	1.01	0.8	0.81	0.95	0.00	0.00
Jan	1.02	0.8	0.82	0.95	0.00	0.00
Feb	1.61	0.8	1.29	0.95	0.00	0.00
Mar	3.12	0.8	2.50	0.70	0.00	0.00
Apr	4.36	0.8	3.49	0.65	1.17	3.55
May	5.55	0.8	4.44	0.60	4.18	12.67
Jun	6.26	0.8	5.01	0.60	5.51	16.70
Jul	6.46	0.8	5.17	0.60	8.08	24.47
Aug	5.92	0.8	4.74	0.60	6.81	20.64
Sep	4.50	0.8	3.60	0.65	5.26	15.93
Oct	3.25	0.8	2.60	0.75	0.69	2.08
	3.71	0.80	2.97		2.64	8.00
	44.57	9.60	35.66		31.71	96.04

Weighted Average of the GRASS, EGS, and EGT together in this one  
 Because could variate the landscaping irrigation per month



**TABLE 2**  
**Spray Field/Seasonal Storage Sizing**  
 Rohnert Park Wastewater Treatment Plant  
 Alternative D No Seasonal Discharge

<b>100-YR MODIFIERS</b>		<b>WWTP INFLUENT FLOWS</b>				<b>STORAGE RESERVOIR</b>				<b>DISPOSAL OPTIONS</b>					
100year Return Ratio	1.83 unitless	Influent Flow	180,000 gpd	Reservoir Watershed Area	11.00 acres	Leachfields	0	Capacity (gpd)	0	Area (acres)	0				
100R modifier -Bn Evaporation	0.8 unitless	Annual Influent Flow	65.7 mg/yr	Sprayfields	0	Landscaping	0	82,085,623.09	0						
100R II Blume	0.0 %	Bn Evap Coefficient	0.75 unitless												
	<b>Units</b>	<b>October</b>	<b>November</b>	<b>December</b>	<b>January</b>	<b>February</b>	<b>March</b>	<b>April</b>	<b>May</b>	<b>June</b>	<b>July</b>	<b>August</b>	<b>September</b>	<b>Season Total</b>	<b>AVG PREC. Season Total</b>
<b>Climate Inputs</b>															
Precipitation (Average)	in	1.56	3.89	6.40	7.19	6.57	4.15	2.04	1.58	1.46	0.56	0.75	0.36	36.49	36.49
Precipitation (100R)	in	2.84	7.10	11.67	13.12	11.99	7.57	3.73	2.88	2.67	1.01	1.35	0.65	66.50	66.50
Bn Evaporation	in	3.60	1.60	1.00	1.20	1.60	3.10	4.40	6.40	7.60	9.10	8.00	6.00	53.60	53.60
Effective Lab Evaporation	in	2.70	1.20	0.75	0.90	1.20	2.33	3.30	4.80	5.70	6.83	6.00	4.50	40.20	40.20
Lab Evap -100R Effective	in	2.70	1.20	0.60	0.72	0.96	1.86	2.64	4.80	5.70	6.83	6.00	4.50	38.51	38.51
Evaporation	in	0	0	0	0	0	0	0	0	0	0	0	0	0.00	0.00
<b>Rohnert Park WWTP</b>															
# Days in Month	days	31	30	31	31	28	31	30	31	30	31	31	30	365	365
Wastewater Influent	MG	5.58	5.40	5.58	5.58	5.09	5.58	5.40	5.58	5.40	5.58	5.58	5.40	65.75	65.75
Wastewater Influent	acft	17.13	16.57	17.13	17.13	15.61	17.13	16.57	17.13	16.57	17.13	17.13	16.57	201.78	201.78
WW Influent #100R II	acft	17.13	16.57	17.13	17.13	15.61	17.13	16.57	17.13	16.57	17.13	17.13	16.57	201.78	201.78
Site Runoff/Recip/Evap	acft	NA	NA	NA	NA	NA	NA	NA	NA	NA	NA	NA	NA	0.00	0.00
<b>Storage Reservoir Contribution</b>															
Reservoir Bl	acft	0.00	12.57	34.55	61.83	90.32	116.03	138.39	147.94	134.69	110.76	67.29	33.55	NA	NA
Reservoir Depth	ft	0.0	1.1	3.1	5.6	8.2	10.5	12.6	13.4	12.2	10.1	6.1	3.1	NA	NA
Reservoir Surface Area	acre	11.0	11.0	11.0	11.0	11.0	11.0	11.0	11.0	11.0	11.0	11.0	11.0	NA	NA
Reservoir Recip (direct)	acft	2.51	6.51	10.70	12.03	10.99	6.94	3.42	2.64	2.44	0.93	1.25	0.60	61.05	8.46
Reservoir Evaporation	acft	2.48	4.10	0.55	0.66	0.88	4.71	2.42	4.40	6.23	6.26	6.50	4.13	35.30	9.90
<b>Disposal</b>															
<b>Leachfields</b>															
Percent Disposed	%	0	0	0	0	0	0	0	0	0	0	0	0	NA	NA
Total Disposed	acft	0.0	0.0	0.0	0.0	0.0	0.0	0.0	0.0	0.0	0.0	0.0	0.0	0.00	0.00
<b>Spray Fields</b>															
Percent Disposed	%	0	0	0	0	0	0	0	0	0	0	0	0	NA	NA
Total Disposed	acft	0.0	0.0	0.0	0.0	0.0	0.0	0.0	0.0	0.0	0.0	0.0	0.0	0.00	0.00
<b>Landscaping</b>															
Total Disposed	acft	4.7	0.0	0.0	0.0	0.0	0.0	8.0	28.6	37.7	55.3	46.6	46.6	227.53	216.90
<b>Effluent Storage</b>															
Beginning Water Volume in Res	acft	0.0	12.6	34.5	61.8	90.3	116.0	138.4	147.9	134.7	110.8	67.3	33.6	NA	NA
Change in Water Volume	acft	12.6	22.0	27.3	28.5	25.7	22.4	9.6	13.3	23.9	43.5	23.7	23.6	0.00	46.55
Final Water Volume in Res	MG	4.1	11.3	20.1	29.4	37.8	45.1	48.2	43.9	36.1	21.9	10.9	0.0	0.0	6.4
Final Water Volume in Res	acft	12.6	34.5	61.8	90.3	116.0	138.4	147.9	134.7	110.8	67.3	33.6	0.0	NA	NA

Areas	acres
Grass	96.00
EGS	0.0
EGT	0.0
Landscape Irrigation	82.1
<b>Total</b>	<b>82.1</b>

Rainfall efficiency: 0.75  
 leachate factor: 1.10  
 Irrigation efficiency: 0.85

EGS= evergreen shrubbery  
 EGT = evergreen tree

Days	Rainfall (inches)	Month	Normal ET <sub>0</sub> (inches)	Grass				EGS				EGT				Total Demand (acre-feet)
				k	ET (inches)	Unit Demand (inches)	Demand (acre-feet)	k	ET (inches)	Unit Demand (inches)	Demand (acre-feet)	k	ET (inches)	Unit Demand (inches)	Demand (acre-feet)	
30	3.35	Nov	1.51	0.8	1.21	0.00	0.00	1.15	1.74	0.00	0.00	1.20	1.81	0.00	0.00	0.00
31	5.40	Dec	1.01	0.8	0.81	0.00	0.00	1.15	1.16	0.00	0.00	1.20	1.21	0.00	0.00	0.00
31	7.15	Jan	1.02	0.8	0.82	0.00	0.00	1.15	1.17	0.00	0.00	1.20	1.22	0.00	0.00	0.00
28	9.57	Feb	1.61	0.8	1.29	0.00	0.00	1.15	1.85	0.00	0.00	1.20	1.93	0.00	0.00	0.00
31	4.15	Mar	3.12	0.8	2.50	0.00	0.00	1.15	3.59	0.62	0.00	1.20	3.74	0.82	0.00	0.00
30	2.04	Apr	4.36	0.8	3.49	2.53	20.25	1.15	5.01	4.51	0.00	1.20	5.23	4.79	0.00	20.25
31	1.58	May	5.55	0.8	4.44	4.22	33.73	1.15	6.38	6.73	0.00	1.20	6.66	7.09	0.00	33.73
30	1.45	Jun	6.26	0.8	5.01	5.06	40.50	1.15	7.20	7.90	0.00	1.20	7.51	8.30	0.00	40.50
31	0.56	Jul	6.48	0.8	5.17	6.15	49.19	1.15	7.43	9.07	0.00	1.20	7.75	9.49	0.00	49.19
31	0.75	Aug	5.92	0.8	4.74	5.41	43.25	1.15	6.81	8.09	0.00	1.20	7.10	8.47	0.00	43.25
30	0.36	Sep	4.50	0.8	3.60	4.31	34.46	1.15	5.18	6.35	0.00	1.20	5.40	6.64	0.00	34.46
31	1.56	Oct	3.25	0.8	2.60	1.85	14.82	1.15	3.74	3.32	0.00	1.20	3.90	3.54	0.00	14.82
##	3.04 Average		3.71		2.97	2.46	19.68	1.15	4.27	3.88	0.00	1.20	4.46	4.09	0.00	19.68
##	36.49 Total		44.57		35.66	29.53	236.21	13.80	51.26	46.58	0.00	14.40	53.48	49.13	0.00	236.21

Month	Normal ET <sub>0</sub> (inches)	Landscape Irrigation				
		k	ET (inches)	Irrigation Efficiency	Unit Demand (inches)	Demand (acre-feet)
Nov	1.51	0.8	1.21	0.95	0.00	0.00
Dec	1.01	0.8	0.81	0.95	0.00	0.00
Jan	1.02	0.8	0.82	0.95	0.00	0.00
Feb	1.61	0.8	1.29	0.95	0.00	0.00
Mar	3.12	0.8	2.50	0.70	0.00	0.00
Apr	4.36	0.8	3.49	0.65	1.17	8.02
May	5.55	0.8	4.44	0.60	4.18	28.62
Jun	6.26	0.8	5.01	0.60	5.51	37.72
Jul	6.48	0.8	5.17	0.60	8.08	55.27
Aug	5.92	0.8	4.74	0.60	6.81	46.61
Sep	4.50	0.8	3.60	0.65	5.26	35.97
Oct	3.25	0.8	2.60	0.75	0.69	4.69
	3.71	0.80	2.97		2.64	18.07
	44.57	9.80	35.66		31.71	216.90

Weighted Average of the GRASS, EGS, and EGT together in this one  
 Because could variate the landscaping irrigation per month

**TABLE 2**  
**Spray Field/Seasonal Storage Sizing**  
**Rohnert Park Wastewater Treatment Plant**  
**Alternative E Seasonal Discharge**

<b>100-YR MODIFIERS</b>		<b>WWTP INFLUENT FLOWS</b>	<b>STORAGE RESERVOIR</b>	<b>DISPOSAL OPTIONS</b>	
100year Return Ratio	1.83 unitless	Influent Flow	67,000 gpd	Capacity (gpd)	Area (acres)
100R modifier - In Evaporation	0.8 unitless	Annual Influent Flow	24.5 mgyr	Reservoir Watershed Area	0.70 acres
100R If Volume	0.0 %	In Evap Coefficient	0.75 unitless	Leachfields	0
				Sprayfields	0
				Landscaping	0
					13.47125672
					0

	Units	100-YEAR ANNUAL PRECIPITATION RETURN PERIOD												AVG PREC. Season Total	
		October	November	December	January	February	March	April	May	June	July	August	September		Season Total
<b>Climate Inputs</b>															
Precipitation Average)	in	1.56	3.89	6.40	7.19	6.57	4.15	2.04	1.58	1.46	0.56	0.75	0.36	36.49	36.49
Precipitation (100R)	in	2.84	7.10	11.67	13.12	11.99	7.57	3.73	2.88	2.67	1.01	1.36	0.66	66.60	66.60
In Evaporation	in	3.60	1.60	1.00	1.20	1.50	3.10	4.40	6.40	7.60	9.10	8.00	6.00	53.60	53.60
Effective La Evaporation	in	2.70	1.20	0.75	0.90	1.20	2.33	3.30	4.80	5.70	6.83	6.00	4.50	40.20	40.20
La Evap -100R Effective	in	2.70	1.20	0.60	0.72	0.96	1.86	2.64	4.80	5.70	6.83	6.00	4.50	38.51	38.51
Evaporation	in	0	0	0	0	0	0	0	0	0	0	0	0	0.00	0.00
<b>Rohnert Park WWTP</b>															
# Days in Month	days	31	30	31	31	26	31	30	31	30	31	31	30	365	365
Wastewater Influent	MG	2.08	0.00	0.00	0.00	0.00	0.00	2.01	2.08	2.01	2.08	2.08	2.01	14.34	14.34
Wastewater Influent	acft	6.37	0.00	0.00	0.00	0.00	0.00	6.17	6.37	6.17	6.37	6.37	6.17	44.00	44.00
WW Influent -100R If	acft	6.37	0.00	0.00	0.00	0.00	0.00	6.17	6.37	6.17	6.37	6.37	6.17	44.00	44.00
Site Runoff/Recip/Evap	acft	NA	NA	NA	NA	NA	NA	NA	NA	NA	NA	NA	NA	0.00	0.00
<b>Storage Reservoir Contribution</b>															
Reservoir Volume	acft	0.00	5.61	0.00	0.00	0.00	0.00	0.00	4.92	6.48	6.28	3.25	1.70	NA	NA
Reservoir Depth	ft	0.0	8.0	0.0	0.0	0.0	0.0	0.0	7.0	9.3	9.0	4.6	2.4	NA	NA
Reservoir Surface Area	acre	0.7	0.0	0.0	0.0	0.0	0.0	0.7	0.7	0.7	0.7	0.7	0.7	NA	NA
Reservoir Recip (direct)	acft	0.17	0.00	0.00	0.00	0.00	0.00	0.22	0.17	0.16	0.06	0.08	0.04	0.88	5.47
Reservoir Evaporation	acft	0.16	0.00	0.00	0.00	0.00	0.00	0.15	0.28	0.33	0.40	0.35	0.26	1.93	6.26
<b>Disposal</b>															
<b>Leachfields</b>															
Percent Disposed	%	0	0	0	0	0	0	0	0	0	0	0	0	NA	NA
Total Disposed	acft	0.0	0.0	0.0	0.0	0.0	0.0	0.0	0.0	0.0	0.0	0.0	0.0	0.00	0.00
<b>Spray Fields</b>															
Percent Disposed	%	0	0	0	0	0	0	0	0	0	0	0	0	NA	NA
Total Disposed	acft	0.0	0.0	0.0	0.0	0.0	0.0	0.0	0.0	0.0	0.0	0.0	0.0	0.00	0.00
<b>Landscaping</b>															
Total Disposed	acft	0.8	0.0	0.0	0.0	0.0	0.0	4.3	4.7	6.2	9.1	7.6	7.6	37.34	35.60
<b>Effluent Storage</b>															
Beginning Water Volume in Res	acft	0.0	5.6	0.0	0.0	0.0	0.0	0.0	4.9	6.5	6.3	3.2	1.7	NA	NA
Change in Water Volume	acft	5.6	0.0	0.0	0.0	0.0	0.0	4.9	1.6	0.2	3.0	4.5	4.7	5.61	7.62
Final Water Volume in Res	MG	1.8	0.0	0.0	0.0	0.0	0.0	1.6	2.1	2.0	1.1	0.6	0.0	1.8	2.5
Final Water Volume in Res	acft	5.6	0.0	0.0	0.0	0.0	0.0	4.9	6.5	6.3	3.2	1.7	0.0	NA	NA

Areas	acres
Grass	96.00
EGS	0.0
EGT	0.0
Landscape Irrigation	13.5
<b>Total</b>	<b>13.5</b>

Rainfall efficiency: 0.75  
 leachate factor: 1.10  
 Irrigation efficiency: 0.85

EGS= evergreen shrubbery  
 EGT = evergreen tree

Days	Rainfall (inches)	Month	Normal ET <sub>0</sub> (inches)	Grass				EGS				EGT				Total Demand (acre-feet)
				k	ET (inches)	Unit Demand (inches)	Demand (acre-feet)	k	ET (inches)	Unit Demand (inches)	Demand (acre-feet)	k	ET (inches)	Unit Demand (inches)	Demand (acre-feet)	
30	3.29	Nov	1.51	0.8	1.21	0.00	0.00	1.15	1.74	0.00	0.00	1.20	1.81	0.00	0.00	0.00
31	3.49	Dec	1.01	0.8	0.81	0.00	0.00	1.15	1.16	0.00	0.00	1.20	1.21	0.00	0.00	0.00
31	7.19	Jan	1.02	0.8	0.82	0.00	0.00	1.15	1.17	0.00	0.00	1.20	1.22	0.00	0.00	0.00
29	6.67	Feb	1.61	0.8	1.29	0.00	0.00	1.15	1.85	0.00	0.00	1.20	1.93	0.00	0.00	0.00
31	4.15	Mar	3.12	0.8	2.50	0.00	0.00	1.15	3.59	0.62	0.00	1.20	3.74	0.82	0.00	0.00
30	2.04	Apr	4.36	0.8	3.49	2.53	20.25	1.15	5.01	4.51	0.00	1.20	5.23	4.79	0.00	20.25
31	1.58	May	5.55	0.8	4.44	4.22	33.73	1.15	6.38	6.73	0.00	1.20	6.66	7.09	0.00	33.73
30	1.46	Jun	6.26	0.8	5.01	5.06	40.50	1.15	7.20	7.90	0.00	1.20	7.51	8.30	0.00	40.50
31	0.59	Jul	6.46	0.8	5.17	6.15	49.19	1.15	7.43	9.07	0.00	1.20	7.75	9.49	0.00	49.19
31	0.75	Aug	5.92	0.8	4.74	5.41	43.25	1.15	6.81	8.09	0.00	1.20	7.10	8.47	0.00	43.25
30	0.36	Sep	4.50	0.8	3.60	4.31	34.48	1.15	5.18	6.35	0.00	1.20	5.40	6.64	0.00	34.48
31	1.06	Oct	3.25	0.8	2.60	1.85	14.82	1.15	3.74	3.32	0.00	1.20	3.90	3.54	0.00	14.82
##	3.04 Average		3.71		2.97	2.46	19.68	1.15	4.27	3.68	0.00	1.20	4.46	4.09	0.00	19.68
##	36.49 Total		44.57		35.66	29.53	236.21	13.80	51.26	46.58	0.00	14.40	53.48	49.13	0.00	236.21

Month	Normal ET <sub>0</sub> (inches)	Landscape Irrigation				
		k	ET (inches)	Irrigation Efficiency	Unit Demand (inches)	Demand (acre-feet)
Nov	1.51	0.8	1.21	0.95	0.00	0.00
Dec	1.01	0.8	0.81	0.95	0.00	0.00
Jan	1.02	0.8	0.82	0.95	0.00	0.00
Feb	1.61	0.8	1.29	0.95	0.00	0.00
Mar	3.12	0.8	2.50	0.70	0.00	0.00
Apr	4.36	0.8	3.49	0.65	1.17	1.32
May	5.55	0.8	4.44	0.60	4.18	4.70
Jun	6.26	0.8	5.01	0.60	5.51	6.19
Jul	6.46	0.8	5.17	0.60	8.08	9.07
Aug	5.92	0.8	4.74	0.60	6.81	7.65
Sep	4.50	0.8	3.60	0.65	5.26	5.90
Oct	3.25	0.8	2.60	0.75	0.69	0.77
	3.71	0.80	2.97		2.64	2.97
	44.57	9.60	35.66		31.71	35.60

Weighted Average of the GRASS, EGS, and EGT together in this one  
 Because could variate the landscaping irrigation per month

**TABLE 2**  
**Spray Field/Seasonal Storage Sizing**  
 Rohnert Park Wastewater Treatment Plant  
 Alternative E No Seasonal Discharge

<b>100-YR MODIFIERS</b>		<b>WWTP INFLUENT FLOWS</b>				<b>STORAGE RESERVOIR</b>				<b>DISPOSAL OPTIONS</b>					
100year Return Ratio	1.83 unitless	Influent Flow	67,000 gpd			Reservoir Watershed Area	4.60 acres			Leachfields	Capacity (gpd) Area (acres)				
100R modifier -En Evaporation	0.8 unitless	Annual Influent Flow	24.5 mg/yr							Sprayfields	0 30.98118267				
100R II blume	0.0 %	En Evap Coefficient	0.75 unitless							Landscaping	0 0 0				
	<b>Units</b>	<b>October</b>	<b>November</b>	<b>December</b>	<b>January</b>	<b>February</b>	<b>March</b>	<b>April</b>	<b>May</b>	<b>June</b>	<b>July</b>	<b>August</b>	<b>September</b>	<b>Season Total</b>	<b>AVG PREC. Season Total</b>
<b>Climate Inputs</b>															
Precipitation (Average)	in	1.56	3.89	6.40	7.19	6.57	4.15	2.04	1.58	1.48	0.56	0.75	0.36	36.49	36.49
Precipitation (100R)	in	2.84	7.10	11.67	13.12	11.99	7.57	3.73	2.88	2.67	1.01	1.36	0.66	66.60	66.60
En Evaporation	in	3.60	1.60	1.00	1.20	1.60	3.10	4.40	6.40	7.60	9.10	8.00	6.00	53.60	53.60
Effective Lab Evaporation	in	2.70	1.20	0.75	0.90	1.20	2.33	3.30	4.80	5.70	6.83	6.00	4.50	40.20	40.20
Lab Evap -100R Effective	in	2.70	1.20	0.60	0.72	0.96	1.86	2.64	4.80	5.70	6.83	6.00	4.50	38.51	38.51
Infiltration	in	0	0	0	0	0	0	0	0	0	0	0	0	0.00	0.00
<b>Rohnert Park WWTP</b>															
# Days in Month	days	31	30	31	31	28	31	30	31	30	31	31	30	365	365
Wastewater Influent	MG	2.08	2.01	2.08	2.08	1.89	2.08	2.01	2.08	2.01	2.08	2.08	2.01	24.47	24.47
Wastewater Influent	acft	6.37	6.17	6.37	6.37	5.81	6.37	6.17	6.37	6.17	6.37	6.37	6.17	75.11	75.11
WW Influent +100R II	acft	6.37	6.17	6.37	6.37	5.81	6.37	6.17	6.37	6.17	6.37	6.37	6.17	75.11	75.11
Site Runoff/precip/evap	acft	NA	NA	NA	NA	NA	NA	NA	NA	NA	NA	NA	NA	0.00	0.00
<b>Storage Reservoir Contribution</b>															
Reservoir bl	acft	0.00	4.66	13.09	23.71	34.84	44.87	53.44	57.00	51.83	42.60	25.89	12.89	NA	NA
Reservoir Depth	ft	0.0	1.0	2.8	5.2	7.6	9.8	11.6	12.4	11.3	9.3	5.6	2.8	NA	NA
Reservoir Surface Area	acre	4.6	4.6	4.6	4.6	4.6	4.6	4.6	4.6	4.6	4.6	4.6	4.6	NA	NA
Reservoir Precip (direct)	acft	1.09	2.72	4.47	5.03	4.59	2.90	1.43	1.10	1.02	0.39	0.52	0.25	25.53	6.33
Reservoir Evaporation	acft	4.04	0.46	0.23	0.28	0.37	0.71	4.01	4.84	2.19	2.62	2.30	4.73	44.76	7.22
<b>Disposal</b>															
<b>Leachfields</b>															
Percent bsd	%	0	0	0	0	0	0	0	0	0	0	0	0	NA	NA
Total Disposed	acft	0.0	0.0	0.0	0.0	0.0	0.0	0.0	0.0	0.0	0.0	0.0	0.0	0.00	0.00
<b>Spray Fields</b>															
Percent bsd	%	0	0	0	0	0	0	0	0	0	0	0	0	NA	NA
Total Disposed	acft	0.0	0.0	0.0	0.0	0.0	0.0	0.0	0.0	0.0	0.0	0.0	0.0	0.00	0.00
<b>Landscaping</b>															
Total Disposed	acft	4.8	0.0	0.0	0.0	0.0	0.0	3.0	40.8	44.2	20.9	47.6	47.6	65.88	81.86
<b>Effluent Storage</b>															
Beginning Water blume in Res	acft	0.0	4.7	13.1	23.7	34.8	44.9	53.4	57.0	51.6	42.6	25.9	12.9	NA	NA
Change in Water blume	acft	4.7	8.4	10.6	11.1	10.0	8.6	3.6	5.2	9.2	46.7	43.0	42.9	0.00	7.65
Final Water blume in Res	MG	1.5	4.3	7.7	11.4	14.6	17.4	18.6	16.9	13.9	8.4	4.2	0.0	0.0	2.5
Final Water blume in Res	acft	4.7	13.1	23.7	34.8	44.9	53.4	57.0	51.8	42.6	25.9	12.9	0.0	NA	NA

Areas	acres
Grass	96.00
EGS	0.0
EGT	0.0
Landscape Irrigation	31.0
<b>Total</b>	<b>31.0</b>

Rainfall efficiency: 0.75  
 leachate factor: 1.10  
 Irrigation efficiency: 0.85

EGS= evergreen shrubbery  
 EGT = evergreen tree

Days	Rainfall (inches)	Month	Normal ET <sub>0</sub> (inches)	Grass			EGS			EGT			Total Demand (acre-feet)			
				k	ET (inches)	Unit Demand (inches)	Demand (acre-feet)	k	ET (inches)	Unit Demand (inches)	Demand (acre-feet)	k		ET (inches)	Unit Demand (inches)	Demand (acre-feet)
30	3.35	Nov	1.51	0.8	1.21	0.00	0.00	1.15	1.74	0.00	0.00	1.20	1.81	0.00	0.00	0.00
31	5.40	Dec	1.01	0.8	0.81	0.00	0.00	1.15	1.16	0.00	0.00	1.20	1.21	0.00	0.00	0.00
31	7.19	Jan	1.02	0.8	0.82	0.00	0.00	1.15	1.17	0.00	0.00	1.20	1.22	0.00	0.00	0.00
28	6.37	Feb	1.61	0.8	1.29	0.00	0.00	1.15	1.85	0.00	0.00	1.20	1.93	0.00	0.00	0.00
31	4.15	Mar	3.12	0.8	2.50	0.00	0.00	1.15	3.59	0.62	0.00	1.20	3.74	0.82	0.00	0.00
30	2.24	Apr	4.35	0.8	3.49	2.53	20.25	1.15	5.01	4.51	0.00	1.20	5.23	4.79	0.00	20.25
31	1.33	May	5.55	0.8	4.44	4.22	33.73	1.15	6.38	6.73	0.00	1.20	6.66	7.09	0.00	33.73
30	1.45	Jun	6.26	0.8	5.01	5.06	40.50	1.15	7.20	7.90	0.00	1.20	7.51	8.30	0.00	40.50
31	0.55	Jul	6.45	0.8	5.17	6.15	49.19	1.15	7.43	9.07	0.00	1.20	7.75	9.49	0.00	49.19
31	0.75	Aug	5.92	0.8	4.74	5.41	43.25	1.15	6.81	8.09	0.00	1.20	7.10	8.47	0.00	43.25
30	0.35	Sep	4.50	0.8	3.60	4.31	34.48	1.15	5.18	6.35	0.00	1.20	5.40	6.64	0.00	34.48
31	1.55	Oct	3.25	0.8	2.60	1.85	14.82	1.15	3.74	3.32	0.00	1.20	3.90	3.54	0.00	14.82
##	3.04 Average		3.71		2.97	2.46	19.68	1.15	4.27	3.88	0.00	1.20	4.46	4.09	0.00	19.68
##	36.49 Total		44.57		35.66	29.53	236.21	13.80	51.26	46.58	0.00	14.40	53.48	49.13	0.00	236.21

Month	Normal ET <sub>0</sub> (inches)	Landscape Irrigation				
		k	ET (inches)	Irrigation Efficiency	Unit Demand (inches)	Demand (acre-feet)
Nov	1.51	0.8	1.21	0.95	0.00	0.00
Dec	1.01	0.8	0.81	0.95	0.00	0.00
Jan	1.02	0.8	0.82	0.95	0.00	0.00
Feb	1.61	0.8	1.29	0.95	0.00	0.00
Mar	3.12	0.8	2.50	0.70	0.00	0.00
Apr	4.35	0.8	3.49	0.65	1.17	3.03
May	5.55	0.8	4.44	0.60	4.18	10.80
Jun	6.26	0.8	5.01	0.60	5.51	14.24
Jul	6.45	0.8	5.17	0.60	6.08	20.86
Aug	5.92	0.8	4.74	0.60	6.81	17.59
Sep	4.50	0.8	3.60	0.65	5.26	13.58
Oct	3.25	0.8	2.60	0.75	0.69	1.77
	3.71	0.80	2.97		2.64	6.82
	44.57	9.60	35.66		31.71	81.86

Weighted Average of the GRASS, EGS, and EGT together in this one  
 Because could variate the landscaping irrigaiton per month



## **APPENDIX C**

Equalization Basin and Emergency Storage Sizing Calculations

Alternative A, B, C and F: Equalization and Emergency Storage Sizing  
 Graton Rancheria Wastewater Treatment Plant

Weekday Flow (gpd) 218,000	Weekend Flow (gpd) 354,000	Design Flow (gpd) (gph) 400,000 16,667
----------------------------------	----------------------------------	--

Start Time	End Time	Factor	Weekday		Weekend		Excess Flows
			Hourly Flow (gph)	(gpd)	Hourly Flow (gph)	(gpd)	
12:00 PM	1:00 PM	0.58	5,268	126,440	8,555	205,320	0
1:00 PM	2:00 PM	0.65	5,904	141,700	9,588	230,100	0
2:00 PM	3:00 PM	0.75	6,813	163,500	11,063	265,500	0
3:00 PM	4:00 PM	0.90	8,175	196,200	13,275	318,600	0
4:00 PM	5:00 PM	1.15	10,446	250,700	16,963	407,100	296
5:00 PM	6:00 PM	1.40	12,717	305,200	20,650	495,600	3,983
6:00 PM	7:00 PM	1.70	15,442	370,600	25,075	601,800	8,408
7:00 PM	8:00 PM	1.90	17,258	414,200	28,025	672,600	11,358
8:00 PM	9:00 PM	2.00	18,167	436,000	29,500	708,000	12,833
9:00 PM	10:00 PM	2.00	18,167	436,000	29,500	708,000	12,833
10:00 PM	11:00 PM	1.90	17,258	414,200	28,025	672,600	11,358
11:00 PM	12:00 AM	1.60	14,533	348,800	23,600	566,400	6,933
12:00 AM	1:00 AM	1.25	11,354	272,500	18,438	442,500	1,771
1:00 AM	2:00 AM	0.95	8,629	207,100	14,013	336,300	0
2:00 AM	3:00 AM	0.75	6,813	163,500	11,063	265,500	0
3:00 AM	4:00 AM	0.60	5,450	130,800	8,850	212,400	0
4:00 AM	5:00 AM	0.50	4,542	109,000	7,375	177,000	0
5:00 AM	6:00 AM	0.50	4,542	109,000	7,375	177,000	0
6:00 AM	7:00 AM	0.50	4,542	109,000	7,375	177,000	0
7:00 AM	8:00 AM	0.50	4,542	109,000	7,375	177,000	0
8:00 AM	9:00 AM	0.50	4,542	109,000	7,375	177,000	0
9:00 AM	10:00 AM	0.50	4,542	109,000	7,375	177,000	0
10:00 AM	11:00 AM	0.50	4,542	109,000	7,375	177,000	0
11:00 AM	12:00 PM	0.52	4,723	113,360	7,670	184,080	0
<b>Total=</b>		<b>1.00</b>	<b>218,908</b>	<b>218,908</b>	<b>355,475</b>	<b>355,475</b>	<b>69,775</b>

Cumulative Excess Flow = 69,775  
 Additional Factor = 0.15  
 Equalization Size = 80,241

Emergency Storage = 218,000  
 (sufficient capacity for a full weekday)

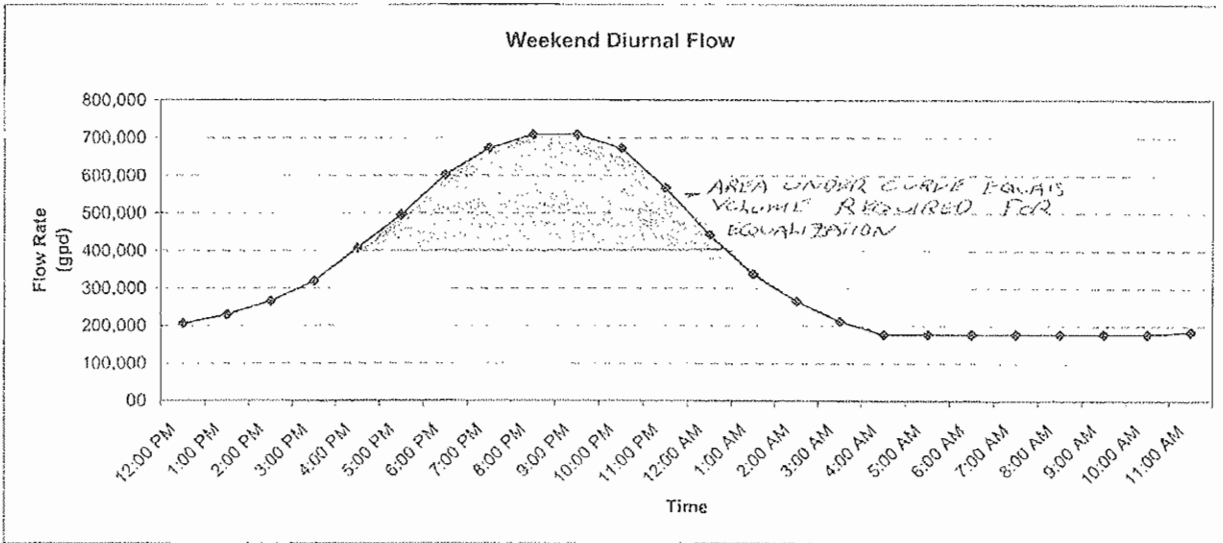

**Alternative D: Equalization and Emergency Storage Sizing**  
**Graton Rancheria Wastewater Treatment Plant**

Weekday Flow (gpd)	Weekend Flow (gpd)	Design Flow (gpd)	(gph)
160,000	227,000	275,000	11,458

Start Time	End Time	Factor	Weekday		Weekend		Excess Flows
			Hourly Flow (gph)	(gpd)	Hourly Flow (gph)	(gpd)	
12:00 PM	1:00 PM	0.58	3,867	92,800	5,486	131,660	0
1:00 PM	2:00 PM	0.65	4,333	104,000	6,148	147,550	0
2:00 PM	3:00 PM	0.75	5,000	120,000	7,094	170,250	0
3:00 PM	4:00 PM	0.90	6,000	144,000	8,513	204,300	0
4:00 PM	5:00 PM	1.15	7,667	184,000	10,877	261,050	0
5:00 PM	6:00 PM	1.40	9,333	224,000	13,242	317,900	1,783
6:00 PM	7:00 PM	1.70	11,333	272,000	16,079	385,900	4,621
7:00 PM	8:00 PM	1.90	12,667	304,000	17,971	431,300	6,513
8:00 PM	9:00 PM	2.00	13,333	320,000	18,917	454,000	7,458
9:00 PM	10:00 PM	2.00	13,333	320,000	18,917	454,000	7,458
10:00 PM	11:00 PM	1.90	12,667	304,000	17,971	431,300	6,513
11:00 PM	12:00 AM	1.60	10,667	256,000	15,133	363,200	3,675
12:00 AM	1:00 AM	1.25	8,333	200,000	11,823	283,750	365
1:00 AM	2:00 AM	0.95	6,333	152,000	8,985	215,650	0
2:00 AM	3:00 AM	0.75	5,000	120,000	7,094	170,250	0
3:00 AM	4:00 AM	0.60	4,000	96,000	5,675	136,200	0
4:00 AM	5:00 AM	0.50	3,333	80,000	4,729	113,500	0
5:00 AM	6:00 AM	0.50	3,333	80,000	4,729	113,500	0
6:00 AM	7:00 AM	0.50	3,333	80,000	4,729	113,500	0
7:00 AM	8:00 AM	0.50	3,333	80,000	4,729	113,500	0
8:00 AM	9:00 AM	0.50	3,333	80,000	4,729	113,500	0
9:00 AM	10:00 AM	0.50	3,333	80,000	4,729	113,500	0
10:00 AM	11:00 AM	0.50	3,333	80,000	4,729	113,500	0
11:00 AM	12:00 PM	0.52	3,467	83,200	4,918	118,040	0
Total=		1.00	160,667		227,946		38,385

Cumulative Excess Flow = 38,385  
 Additional Factor = 0.15  
 Equalization Size = 44,143  
  
 Emergency Storage = 160,000  
 (sufficient capacity for a full weekday)

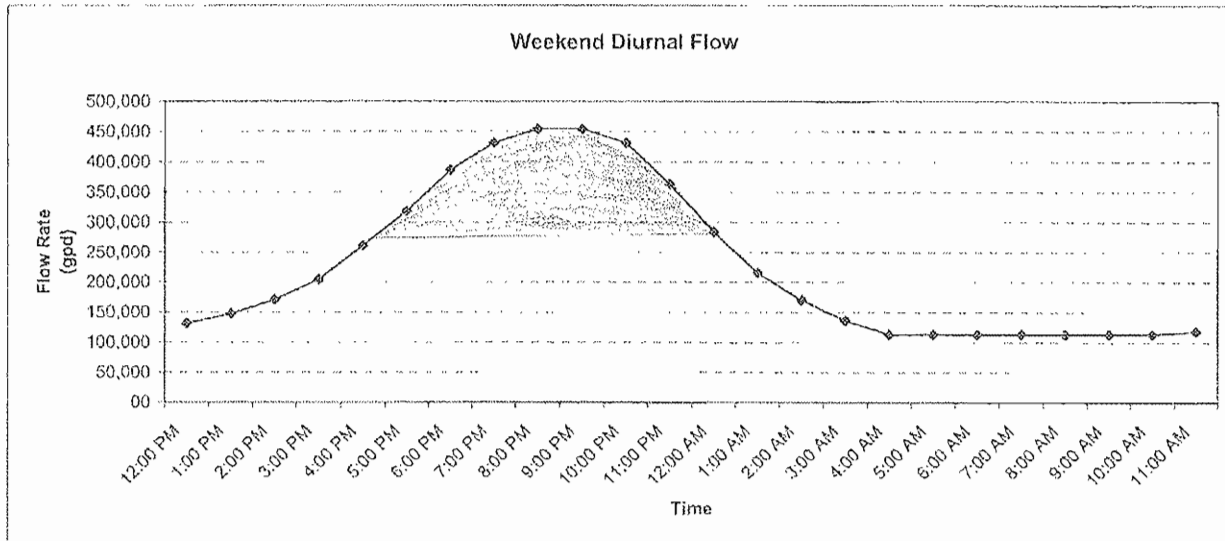

**Alternative E: Equalization and Emergency Storage Sizing**  
**Graton Rancheria Wastewater Treatment Plant**

Weekday Flow (gpd) 78,000      Weekend Flow (gpd) 39,000      Design Flow (gpd) 90,000      (gph) 3,750

Start Time	End Time	Factor	Weekday		Weekend		Excess Flows
			Hourly Flow (gph)	(gpd)	Hourly Flow (gph)	(gpd)	
12:00 PM	1:00 PM	1.70	5,525	132,600	2,763	66,300	1,775
1:00 PM	2:00 PM	1.75	5,688	136,500	2,844	68,250	1,938
2:00 PM	3:00 PM	1.75	5,688	136,500	2,844	68,250	1,938
3:00 PM	4:00 PM	1.70	5,525	132,600	2,763	66,300	1,775
4:00 PM	5:00 PM	1.65	5,363	128,700	2,681	64,350	1,613
5:00 PM	6:00 PM	1.50	4,875	117,000	2,438	58,500	1,125
6:00 PM	7:00 PM	1.20	3,900	93,600	1,950	46,800	150
7:00 PM	8:00 PM	0.95	3,088	74,100	1,544	37,050	0
8:00 PM	9:00 PM	0.70	2,275	54,600	1,138	27,300	0
9:00 PM	10:00 PM	0.52	1,690	40,560	845	20,280	0
10:00 PM	11:00 PM	0.40	1,300	31,200	650	15,600	0
11:00 PM	12:00 AM	0.30	975	23,400	488	11,700	0
12:00 AM	1:00 AM	0.25	813	19,500	406	9,750	0
1:00 AM	2:00 AM	0.20	650	15,600	325	7,800	0
2:00 AM	3:00 AM	0.20	650	15,600	325	7,800	0
3:00 AM	4:00 AM	0.20	650	15,600	325	7,800	0
4:00 AM	5:00 AM	0.30	975	23,400	488	11,700	0
5:00 AM	6:00 AM	0.50	1,625	39,000	813	19,500	0
6:00 AM	7:00 AM	0.90	2,925	70,200	1,463	35,100	0
7:00 AM	8:00 AM	1.20	3,900	93,600	1,950	46,800	150
8:00 AM	9:00 AM	1.40	4,550	109,200	2,275	54,600	800
9:00 AM	10:00 AM	1.50	4,875	117,000	2,438	58,500	1,125
10:00 AM	11:00 AM	1.60	5,200	124,800	2,600	62,400	1,450
11:00 AM	12:00 PM	1.65	5,363	128,700	2,681	64,350	1,613
<b>Total=</b>		<b>1.00</b>	<b>78,065</b>		<b>39,033</b>		<b>15,450</b>

Cumulative Excess Flow = 15,450  
 Additional Factor = 0.15  
 Equalization Size = 17,768

Emergency Storage = 78,000  
 (sufficient capacity for a full weekday)

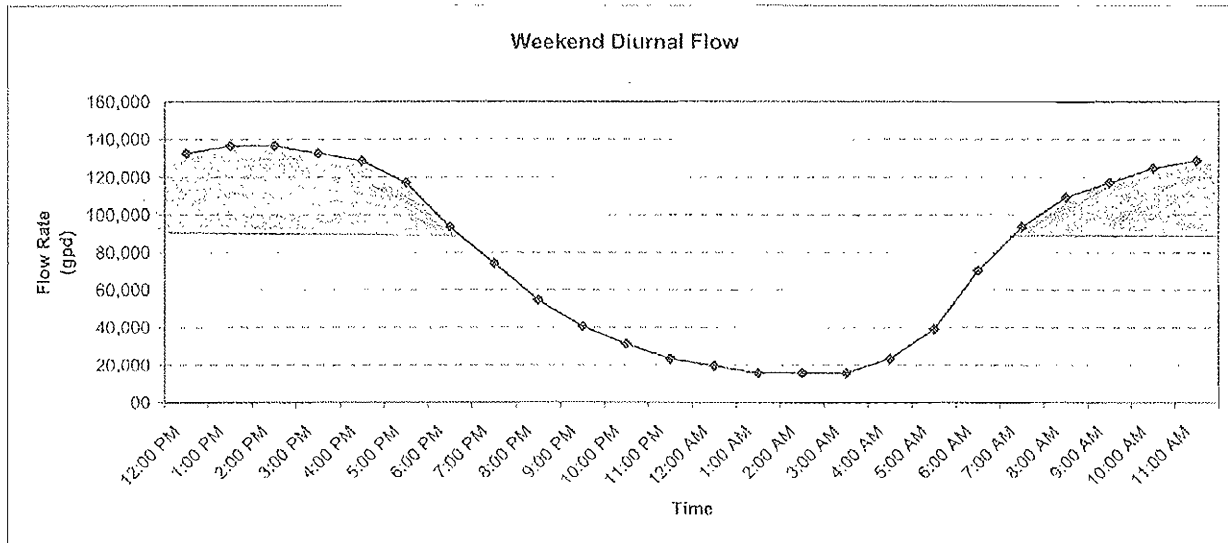

# **54-Inch Culvert Flow Capacity Estimate**

Graton Rancheria Hotel and Casino Project

**Capacity Estimate Basis:**

The capacity of the 54-inch culvert at the terminus of a ditch draining several fields on the east side of the Bellevue-Wilfred Channel was estimated for worst case flood conditions. It was assumed that this would occur when the culvert discharge is fully submerged by the water level in the Bellevue-Wilfred Channel, resulting in Type-4 (fully submerged) culvert flow. This would occur at an approximate elevation of 80 ft.

If the water level were to drop below this level, leaving the discharge only partially submerged, the flow is expected to be considerably larger than under the submerged scenario. This was not evaluated as a part of the worst case flow analysis.

General survey data was combined with field work to give approximate dimensions and elevations for this estimate.

In Type-4 culvert flow, tailwater elevation becomes the controlling factor for the discharge capacity. The flow through the culvert becomes a function of drainage ditch water surface elevation (headwater) and the elevation in the Bellevue-Wilfred Channel (tailwater). The maximum headwater elevation was assumed to be 84.7 ft, roughly 0.5 ft below the lowest adjacent field elevation. It was assumed that if the water level were to exceed this elevation, wastewater treatment plant discharge would be temporarily stored until the water level had receded. If the water level dropped below this maximum in the drainage ditch, the flow through the culvert would be reduced. However, it was assumed that if this reduced flow rate were insufficient, the water level in the ditch could rise to increase flow rate, up to the maximum elevation at which point discharge would be temporarily stored.

Under Type-4 culvert flow, it was assumed that flow was dependent on headwater and tailwater elevation, as discussed above, as well as culvert diameter, roughness, length, and hydraulic radius when flowing full. Flow was assumed to be independent of slope under fully submerged conditions.

The culvert capacity was estimated using the following equation, as found in *The Civil Engineering Reference Manual*, Tenth Edition, Michael R Lindeburg, 2006.

$$Q = C_d A_0 \sqrt{2g \left( \frac{h_1 - h_4}{1 + \frac{29C_d^2 n^2 L}{R^{4/3}}} \right)}$$

Q = Flow Rate (cfs)

$C_d$  = Discharge Coefficient (0.6 to 1.0), dependent on entrance geometry

$A_0$  = Culvert Cross Section Area

g = Gravitational Constant (32.2 ft/s<sup>2</sup>)

$h_1$  = Headwater Elevation (ft)

$h_4$  = Tailwater Elevation (ft)

n = Manning's Constant (0.024 for Corrugated Metal Pipe)

L = Culvert Length (ft)

R = Hydraulic Radius (Culvert Area / Wetted Perimeter = D/4 for a pipe flowing full).



**Discharge Impact:**

The projected average weekend wastewater discharge from the Graton Rancheria Hotel and Casino Project is around 0.35 mgd or 0.54 cfs. This is much less than the projected culvert capacity of 69 cfs with a 1 ft difference in elevation between the headwater and tailwater elevations. The pre-development peak storm water flow from the area of the site to be developed was estimated to be 25 cfs, with attenuation, the peak flow post-development should be the same, including the impact of the wastewater discharge. Additional capacity was provided in the storm water detention basin to store a day of wastewater discharge to attenuate the increase in the peak flow from this discharge ("Site Grading and Storm Drainage," Robert A Karn and Associates, Inc., 2006).

The Culvert is expected to receive water draining from the entire developed portion of the site as well as a number of other areas.

**Assumptions:**

- Under flood conditions, wastewater would be temporarily stored.
- Worst case capacity occurs when the culvert discharge end is fully submerged and Type-4 culvert flow occurs.
- The maximum water elevation in the drainage ditch would be approximately 84.7 ft, roughly 0.5 ft below the lowest adjacent field elevation.
- Discharge would only occur when the water elevation in the Bellevue-Wilfred Channel was at least 1 ft below this elevation.
- Entrance velocity head, entrance friction loss, and the exit friction loss are all neglected.
- The discharge coefficient  $C_d$  was assumed to be 0.6.  $C_d$  can range from 0.6 to 1.0, the most conservative value was used.
- The Manning's constant  $n$  for corrugated metal pipe was assumed to be 0.024, consistent with standard practice.



HydroScience Engineers, Inc.

PROJECT: GRATION RANCHERIA  
 SUBJECT: CONVERT ALLOCATION  
 JOB NO. 129-045-100

DESIGNED BY: KPH  
 CHECKED BY: \_\_\_\_\_  
 DATE: \_\_\_\_\_  
 SHEET NO. \_\_\_\_\_

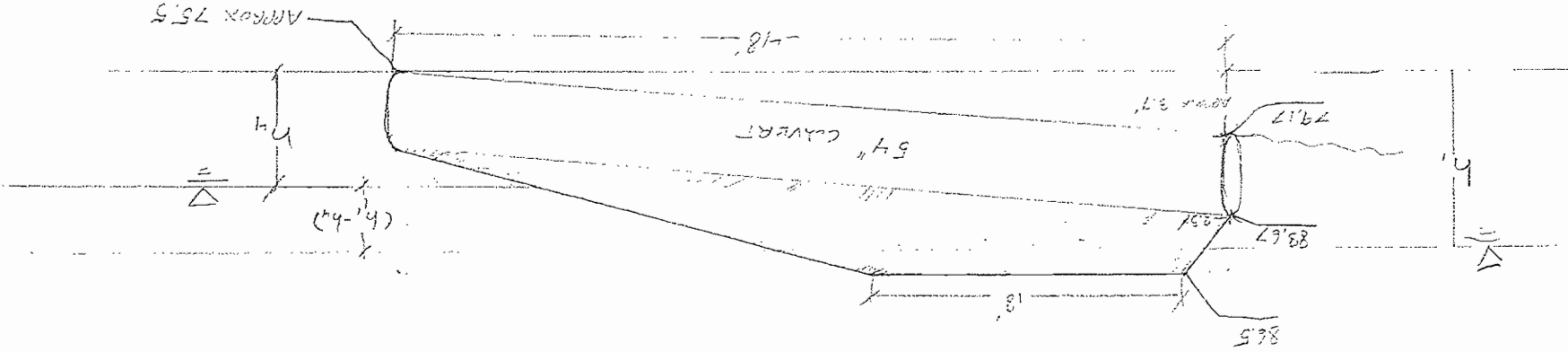

EXIT FULLY SUBMERGED  
 ALL ELEVATIONS APPROXIMATE

TYPE II FLOW

$$Q = Cd A_0 \sqrt{2gh} \left( \frac{h_1 - h_2}{1 + 29 \frac{Cd^2 n^2 L}{R^{4/3}}} \right)$$

$$A_0 = \pi D^2 \frac{h}{4} = \pi 4.5^2 \frac{h}{4} = 15.9 \text{ ft}^2$$

$$R = A/P = \pi r^2 / \pi r = r = 4.5 \text{ ft} = 1.125 \text{ ft}$$

$$Cd = 0.6 - 1.0 \text{ (ASSUMED } 0.6)$$

$$n = 0.024 \text{ FOR CMP}$$

FOR  $h_1 - h_2 = 1'$

$$Q = 0.6 \cdot 15.9 \text{ ft}^2 \sqrt{2 \left( 32.2 \frac{\text{ft}}{\text{s}^2} \right)} \left( \frac{1 \text{ ft}}{1.125 \text{ ft}^{4/3}} \right) \left( \frac{1 + 29 (0.6)^2 (0.024)^2 (-18 \text{ ft})}{(1.125 \text{ ft}^{4/3})} \right)$$

$$= 9.54 \text{ ft}^3 \cdot \sqrt{51.66 \frac{\text{ft}}{\text{s}^2}} = 68.57 \frac{\text{ft}^3}{\text{s}} = 69 \text{ CFS}$$

## Culvert Analysis

Type 4 Flow: Submerged outlet

Entered	Calculated		
$h_1 = 9.2$ max (84.7-75.5 ft elevation)	$R =$	1.125 ft	(Hydraulic Radius D/4)
$n = 0.024$ (Manning's Roughness Coefficient for CMP)	$A_0 =$	15.9 ft <sup>2</sup>	(Culvert Flowing Full)
$C_d = 0.6$ (discharge coefficient assumed)			
$h_4 = 4.5$ to 8.2			
$g = 32.2$ ft/s <sup>2</sup>			
$L = 48$ ft			
$D = 4.5$ ft			
$Q_{\text{wastewater}} = 0.4$ mgd			

$$Q = C_d A_0 (2g(h_1 - h_4) / (1 + 29C_d^2 n^2 L / R^{4/3}))^{0.5}$$

Type 4: Full flow, submerged outlet			
( $h_1 - h_4$ )	Q (cfs)	Q (gpm)	Q (mgd)
1.0	69	30,800	44.3
1.5	84	37,700	54.3
2.0	97	43,500	62.7
2.5	108	48,700	70.1
3.0	119	53,300	76.8
3.5	128	57,600	82.9
4.0	137	61,600	88.6
4.5	145	65,300	94.0
4.7	149	66,700	96.1