

APPENDIX C

Site Grading and Storm Drainage

SITE GRADING AND STORM DRAINAGE

**Proposed Gaming Facility
Federated Indians of Graton Rancheria
Sonoma County, California**

**ALTERNATE SITES
Wilfred, Stony Point and Lakeville**



**ROBERT A. KARN
& ASSOCIATES, INC.**

707 BECK AVENUE
FAIRFIELD, CALIFORNIA 94533
Phone: (707) 435-9999 Fax: (707) 435-9988
e-mail: rakerakengineers.com

**January 2004
Rev. October 2004
Rev. January 2006
Rev. August 2007
Rev. September 2007**

TABLE OF CONTENTS

Section I

Wilfred Site

INTRODUCTION 2

EXISTING SITE DESCRIPTION 5

FLOODPLAIN 5

STORMWATER HYDROLOGY 6

STORMWATER DETENTION ANALYSIS 8

DRAINAGE IMPROVEMENTS 11

 Overland Drainage Release 11

 Detention Basin Grading 11

 Building and Parking Lot Grading & Drainage 11

EROSION CONTROL 13

SUMMARY..... 13

LIST OF TABLES

Table 1 – Hydrologic Parameters 7

Table 2 – Increased Volumes & Storage Volumes 8

LIST OF FIGURES

Figure 1 Wilfred Site Layouts A & H 1

Figure 2 Project Boundary & Location Map 3

Figure 3 Floodplain Boundary Wilfred Site 4

Figure 4 Layouts A & H Southern Storm Drainage Detention 9

Figure 5 Wilfred Site Layout A On-Site Storm Drainage Detention 10

Figure 6 Wilfred Site Overland Drainage Release 12

Section II

Stony Point Site

INTRODUCTION	15
EXISTING SITE DESCRIPTION	21
FLOODPLAIN ENCROACHMENT	21
STORMWATER HYDROLOGY	22
STORMWATER DETENTION ANALYSIS	24
DRAINAGE IMPROVEMENTS	25
Overland Drainage Release	25
Detention Basin Grading	25
Building and Parking Lot Grading & Drainage	25
EROSION CONTROL	30
SUMMARY	30

LIST OF TABLES

Table 3 – Floodplain Encroachment.....	21
Table 4 – Hydrologic Parameters	23
Table 5 – Increased Volumes and Storage Volumes	24

LIST OF FIGURES

Figure 7 Stony Point Site Alternate Layouts B, C, D, & E	14
Figure 8 Stony Point Site Boundary	16
Figure 9 Floodplain Boundary Stony Point Site	17
Figure 10a-b Alternate Site Locations Layouts B & C	18
Figure 10c Alternate Layout D.....	19
Figure 10d Alternate Layout E.....	20
Figure 11 Northwest Overland Drainage Release	26

Figure 12	Northeast Overland Drainage Release	27
Figure 13	Northwest Stony Point Site Storm Drainage Detention Basin Location and Volume	28
Figure 14	Northeast Stony Point Site Storm Drainage Detention Basin Location and Volume	29

Section III

Lakeville Site	
INTRODUCTION	32
EXISTING SITE DESCRIPTION	35
FLOODPLAIN ENCROACHMENT	35
STORMWATER HYDROLOGY	36
STORMWATER DETENTION ANALYSIS	37
DRAINAGE IMPROVEMENTS	38
Overland Drainage Release	38
Detention Basin Grading	38
Building and Parking Lot Grading & Drainage.....	38
EROSION CONTROL	41
SUMMARY.....	41

LIST OF TABLES

Table 6 – Floodplain Encroachment.....	35
Table 7 – Increased Volumes and Storage Volumes	37

LIST OF FIGURES

Figure 15 Lakeville Site	31
Figure 16 Project Boundary and Location Map	33
Figure 17 Floodplain Boundary	34
Figure 18 Overland Drainage Release	39
Figure 19 Storm Drainage Detention Basin Location and Volume	40

APPENDICES

- A – SCS Unit Hydrographs & Calculations
- B – Preliminary Grading & Storm Drain Storage Plans
- C – Existing Storm Drain Culverts
- D – Sample Best Management Practices

SECTION-I Wilfred Site Layouts A & H

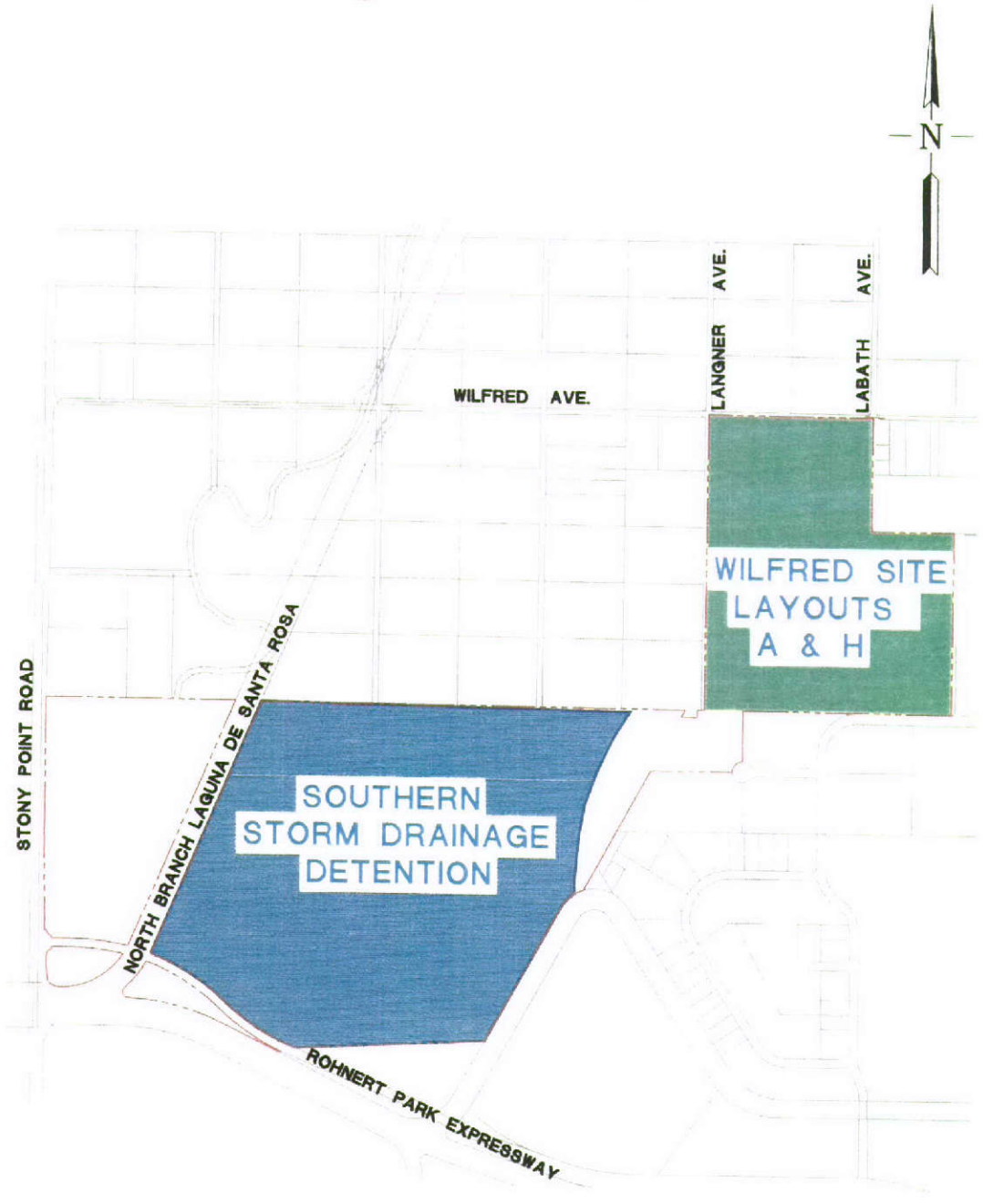

FIGURE 1

**SITE GRADING AND
STORM DRAINAGE (WILFRED SITE)
PROPOSED GAMING FACILITY
FEDERATED INDIANS OF GRATON RANCHERIA
SONOMA COUNTY, CALIFORNIA**

INTRODUCTION

This report presents preliminary site grading and storm drainage plans for the proposed Gaming Facility in Sonoma County located at the northeastern portion of the Wilfred Site in Sonoma County, California. (See Figure 2, the Wilfred Site)

The plans were based upon architectural layout A and a reduced intensity layout H. This report and associated plans were intended to provide information for the environmental analysis of the project. The final architectural design and site development plan for the project may require revisions to the plans presented in this report.

The Flood Insurance Rate Map entitled "Sonoma County, California (Unincorporated Areas) Community Panel Number 060375 0855B" designates the proposed developed portion of the Wilfred Site as located outside of the 100 year floodplain of the Laguna de Santa Rosa and the Bellevue-Wilfred Flood Control Channel.

The proposed Gaming Facility for both layouts A & H are located within an area designated as Zone X. Zone X is defined as: "Areas of 500-year flood; areas of 100-year flood with average depths less than 1 foot or with drainage areas less than 1 square mile; and areas protected by levels from 100-year flood." National floodplain management regulations do not apply to areas designated as a Zone X.

The Flood Insurance Rate Map also designates a portion of the remaining undeveloped Wilfred Site as located within the 100-year floodplain. (See Figure 3).

The grading and drainage plan incorporates two areas for storm water detention to mitigate increase in storm runoff created by the development of the proposed Gaming Facility.

The grading and drainage plan incorporates fill to elevate the proposed Gaming Facility allowing storm water to empty into a detention basin. The storm water detention basin will attenuate the increase in peak flow created by the development of the casino and parking lots. In addition, the storm water

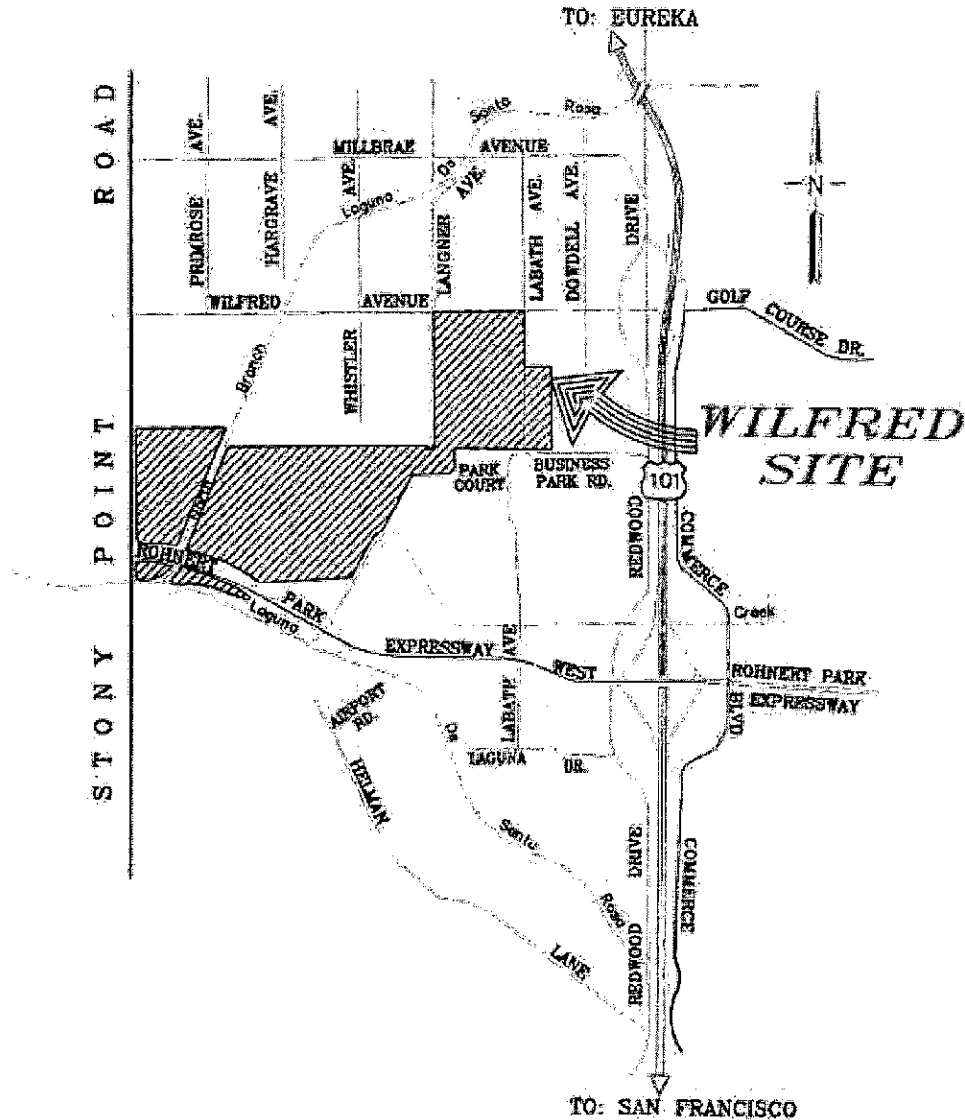

**PROJECT BOUNDARY
& LOCATION MAP**

FIGURE 2

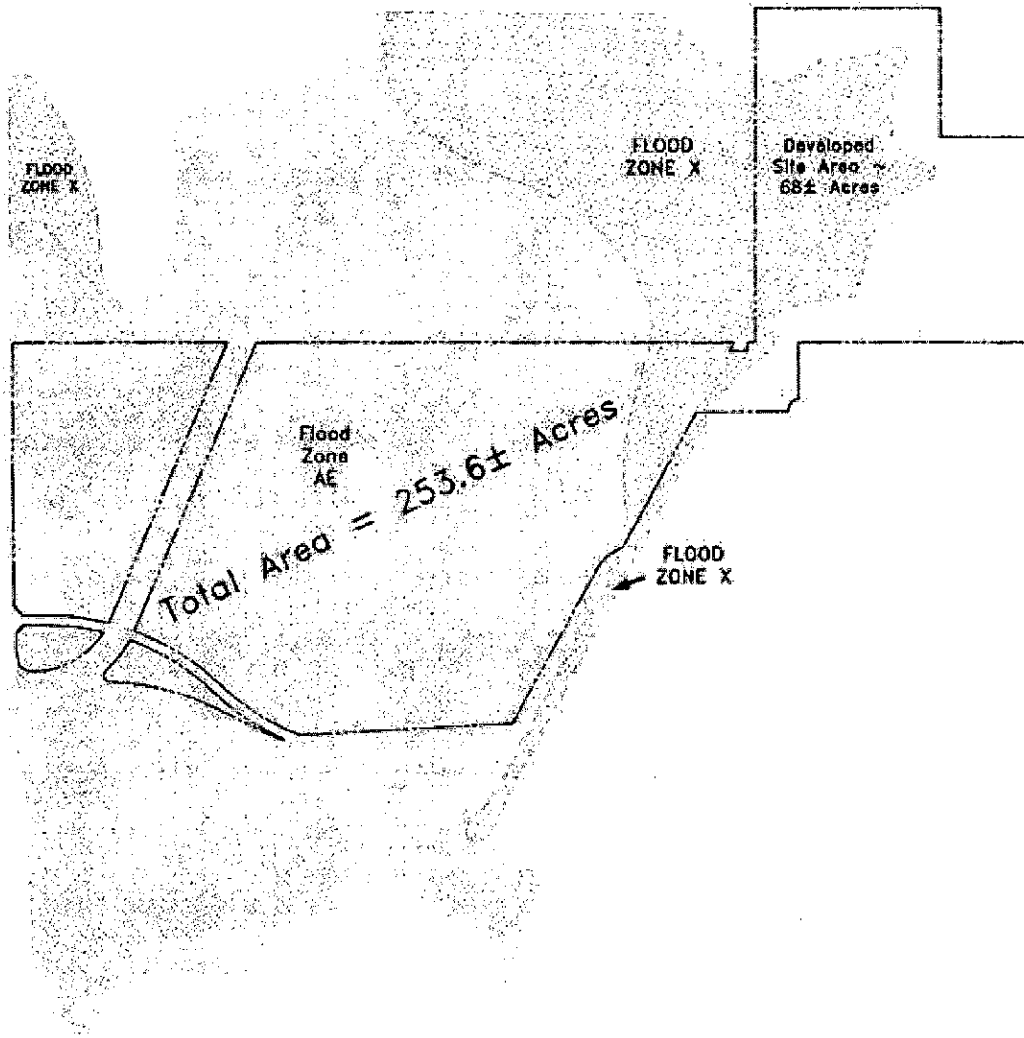

**FLOOD PLAIN BOUNDARY
WILFRED SITE**

FIGURE 3

development of the casino and parking lots. In addition, the storm water detention basin can attenuate the increase in peak flow that would be generated by obtaining a permit to release 300,000 gallons per day of tertiary treated effluent from the proposed onsite sanitary sewage treatment plant.

The second storm water detention area known as the Southern detention basin is proposed to be created in the Southern portion of the Wilfred Site with the area bounded on the west by the Bellevue-Wilfred Channel the south by Rohnert Park Expressway and the East by Hinebaugh Creek. (See Figure 4). This detention area will allow for additional storage area to account for the fill placed in the non-regulated Zone X.

EXISTING SITE DESCRIPTION

The site consists of approximately 253.6 acres of grazing and pasture land. The site is bounded by Wilfred Avenue on the north, Stony Point Road on the west, Dowdell Avenue on the east, and Rohnert Park Expressway on the south.

The existing topography is relatively flat and slopes slightly towards the south. La Bath Creek flows westerly through the northeastern portion of the site to Hinebaugh Creek.

FLOODPLAIN

The proposed Gaming Facility is located within Floodplain Zone X as shown on Flood Insurance Rate Map entitled "Sonoma County, California (Unincorporated Areas) Community Panel Number 060375 0855B." A Zone X is a non-regulated Flood Zone that is located outside the 100-year floodplain. Zone X is an area of 500-year flood; areas of 100-year flood with average depths of less than 1 foot or with drainage areas less than 1 square mile; and areas protected by levees from 100-year flood. Based upon this fact, this project does not encroach into a regulated floodplain and although there is no need to address floodplain encroachment, the project proposes to create two detention ponds.

STORMWATER HYDROLOGY

A hydrologic investigation was performed to estimate the 100 year storm runoff for the pre and post development of the site for both alternative site plans.

The Haestad Pond Pack Software was utilized to develop Soil Conservation Service (SCS) unit hydrographs. The hydrographs were analyzed to determine the volume of storm drainage detention required.

Watershed area was calculated for the site based upon the preliminary architectural site plan.

The soil type was identified by Michelucci & Associates, Inc. field investigation. The SCS curve numbers (CN) for the existing and developed site were determined utilizing the hydrologic soil groups as defined by the Natural Resource Conservation Service. Technical Release 55 (TR55) Table 2-2a and 2-2c were used to establish the CN values.

The time of concentration was assumed to be 0.5 hours for these calculations.

Rainfall-Intensity-Duration curve was generated from the Sonoma County Water Agency Flood Control Design Criteria Manual dated March 29, 1999.

The Rainfall Distribution Type IA was used based upon the approximate geographic boundaries for SCS rainfall distribution as presented in Pond Pack 10.0 User's Guide.

The parameters used are summarized in Table 1.

The SCS Unit Hydrographs and the associated calculations are included with this report as Appendix A.

**Table 1
Hydrologic
Parameters**

Parameter	Value Wilfred Site	Source
Water Shed Area	73.0+ Acres	Measured from Architectural Layout A
Runoff Curve Number	79 Undeveloped Site 94 Developed Site	Curve numbers were estimated using the soils classified by the Natural Resource Conservation, the field Investigations performed by Michelucci & Associates, Inc. and Tables 2-2a, Table 2-2c of 210-VI-TR-55, Second Edition were used (Figures 5,6 & 7).
Time of Concentration	0.5 Hours	Assumption is made per the type of soil and as the existing Conditions.
Rainfall Intensities	1.68 inches / hour	Sonoma County Water Agency, Flood design Criteria Dated March 1999.
Rain Fall Distribution	SCS Type -IA	As per the hydrological boundaries

STORMWATER DETENTION ANALYSIS

To mitigate offsite impacts, the stormwater drainage system for the proposed project is designed to limit the peak flow from the developed site to predevelopment peak flows. To accomplish this, on-site storm water detention has been incorporated into the southerly portion of the developed project site. The basin size takes into account the increase in runoff created by increased impervious surfaces and the potential for 300,000 gallons per day (1AcFt) of treated wastewater effluent.

In addition, the southern detention area is included to mitigate the fill that is proposed to be placed in the non-regulated Zone X Floodplain. The depth of Zone X is considered to be an average of 1 foot. Therefore, the storage required to mitigate the 1 foot of fill over approximately 73 acres is 73 acre-feet for Layout A and 63 acre-feet for Layout H.

The increase in volumes due to development and storage volumes for the site are shown in Table 2.

Although the proposed development of the project increases runoff and peak flow rates, the storage pond temporarily stores the runoff to limit the peak flow. The storage pond will empty into the existing La Bath Creek through 3 – 8” CMP pipes and 2 – 12” CMP pipes to pre-project levels (See Figure 5 for locations). A preliminary grading plan for the detention basin is included as Appendix B.

TABLE 2 – Increased Volumes & Storage Volumes

	Layout A	Layout H
<u>INCREASED RUN-OFF</u>		
INCREASE DUE TO DEVELOPMENT	9.5 AcFt	8.2 AcFt
INCREASE DUE TO EFFLUENT DISCHARGE	1.0 AcFt	1.0 AcFt
ZONE Z FLOOD PLAIN ENCROACHMENT	73.0 AcFt	63.0 AcFt
A = TOTAL STORAGE REQUIRED	83.5 AcFt	72.2 AcFt
<u>STORAGE PROVIDED</u>		
ON-SITE DETENTION POND	14.0 AcFt	14.0 AcFt
SOUTHERN DETENTION POND	178.0 AcFt	178.0 AcFt
B = TOTAL STORAGE PROVIDED	192.0 AcFt	192.0 AcFt
A-B = SURPLUS STORAGE	108.5 AcFt	119.8 AcFt



WILFRED SITE
 LAYOUT A
 ON-SITE STORM DRAINAGE DETENTION

STORM DRAIN
 14.0 AC FT
 STORAGE DUE TO
 DEVELOPMENT

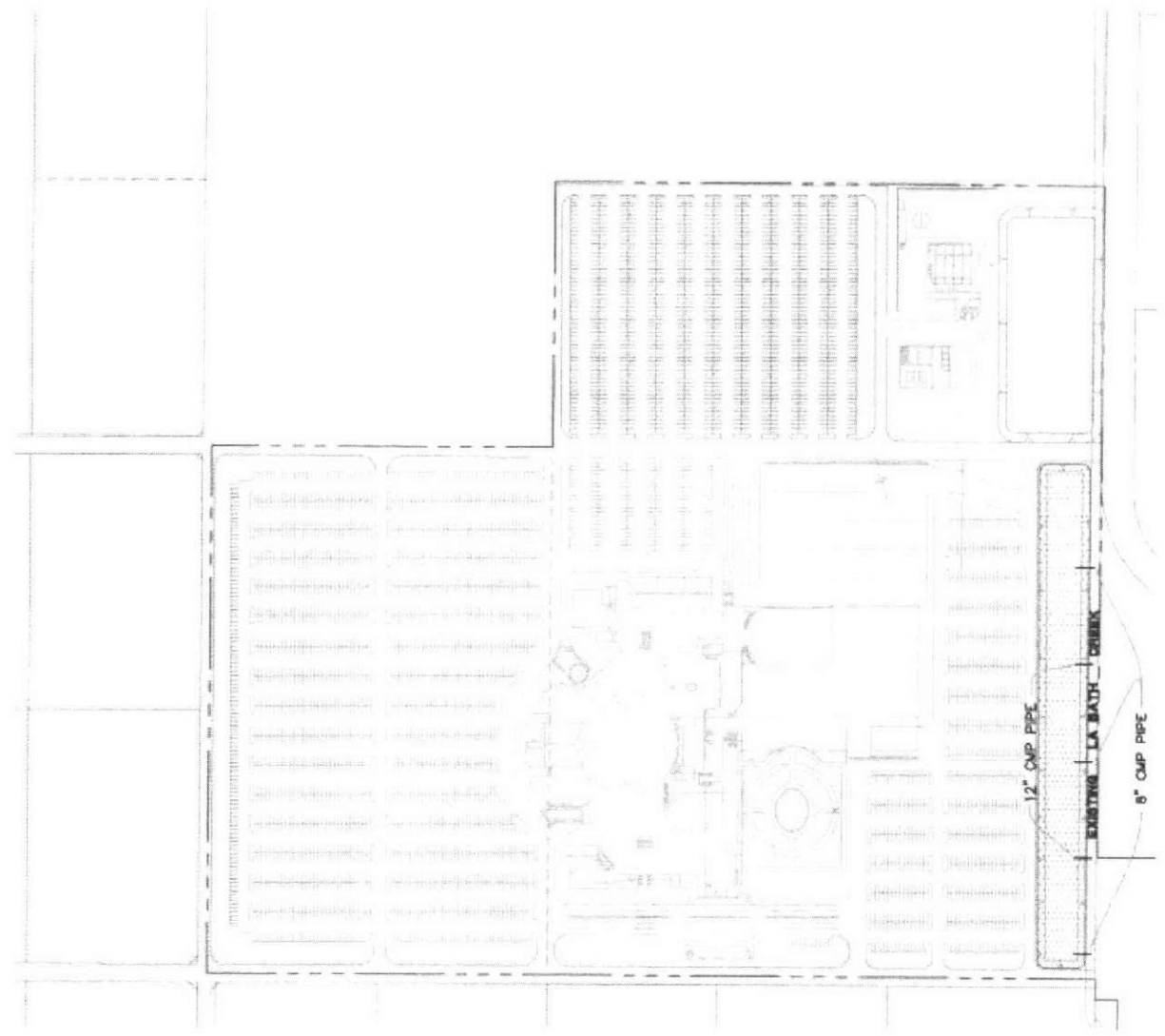

AD30563 Report Revised November 2008 Section 1 - Wilfred Site Attachment 1.dwg

FIGURE 5

DRAINAGE IMPROVEMENTS

The development of the project will include several storm drainage improvements. The following sections describe the recommended improvements.

Overland Drainage Release

As the project is developed, an overland drainage will be created to allow the property to drain under overflow conditions. The overland drainage release will be around the perimeter of the site and is shown on Figure 6. The overland drainage release is identical for Layouts A & H.

On-Site and Southern Detention Basin Grading

Figure 3 shows the proposed location and volume for the on-site detention basin. A preliminary grading plan is included in Appendix B that provides a more detailed grading analysis. Figure 4 shows the proposed locations and volume for the southern detention basin. The construction of the detention basins will be coordinated with the biological consultant to minimize wetland and habitat disturbance and to allow for creation of additional habitat areas.

LAYOUT A

Building and Parking Lot Grading and Drainage

It is estimated that 300,000 cubic yards of earthwork will be required to develop the Layout A site plan. Onsite excavation will yield approximately 25,000 cubic yards of fill material creating the southern detention pond will yield the remaining fill material. It is anticipated that the on-site grading will balance based upon the southern detention system excavation being used on-site. Onsite drainage systems will consist of an underground piped drainage system. Inlets will be placed at appropriate intervals to capture runoff and convey to the detention basins.

The aggregate base and asphalt necessary to pave this site is available from local quarries. In addition, recycled material is available to supplement these sources. The material needs for this project fall within normal production runs for the quarries.

Roof leaders should be connected directly to the pipe system and parking lots should be constructed with a 1% minimum slope and 5% maximum slope toward the inlets.

LAYOUT H

Building and Parking Lot Grading and Drainage

It is estimated that 270,000 cubic yards of earthwork will be required to develop the Layout H site plan. Onsite excavation will yield approximately 25,000 cubic



WILFRED SITE OVERLAND DRAINAGE RELEASE

FIGURE 6

yards of fill material creating the southern detention pond will yield the remaining fill material. It is anticipated that the on-site grading will balance based upon the southern detention system excavation being used on-site. Onsite drainage systems will consist of an underground piped drainage system. Inlets will be placed at appropriate intervals to capture runoff and convey to the detention basins.

Roof leaders should be connected directly to the pipe system and parking lots should be constructed with a 1% minimum slope and 5% maximum slope toward the inlets.

EROSION CONTROL

An erosion control plan will be developed with the primary intent to decrease pollutants entering the water columns, with a secondary intent of trapping pollutants before they exit the site.

A Storm Water Pollution Prevention Plan should be prepared as part of the project to provide a level of protection equivalent to full compliance with the Statewide General Construction Activities Storm Water Permit adopted by the Storm Water Resources Control Board.

A partial list of Best Management Practices (BMP's) is included as Appendix D.

SUMMARY

The impacts associated with an increase in storm runoff as a result of development can be mitigated through the creation of a detention pond on the southern portion of the site.

The excavation associated with the on-site detention pond would create a portion of fill necessary to achieve the design grades. Creating the southern detention pond will yield the remaining fill material. It is anticipated that the on-site grading will balance based upon the off-site detention system excavation being used on-site. In addition, an overland drainage release for the property can be maintained around the perimeter of the developed site.

SECTION-II

Stony Point Site

Alternate Layouts B, C, D, & E

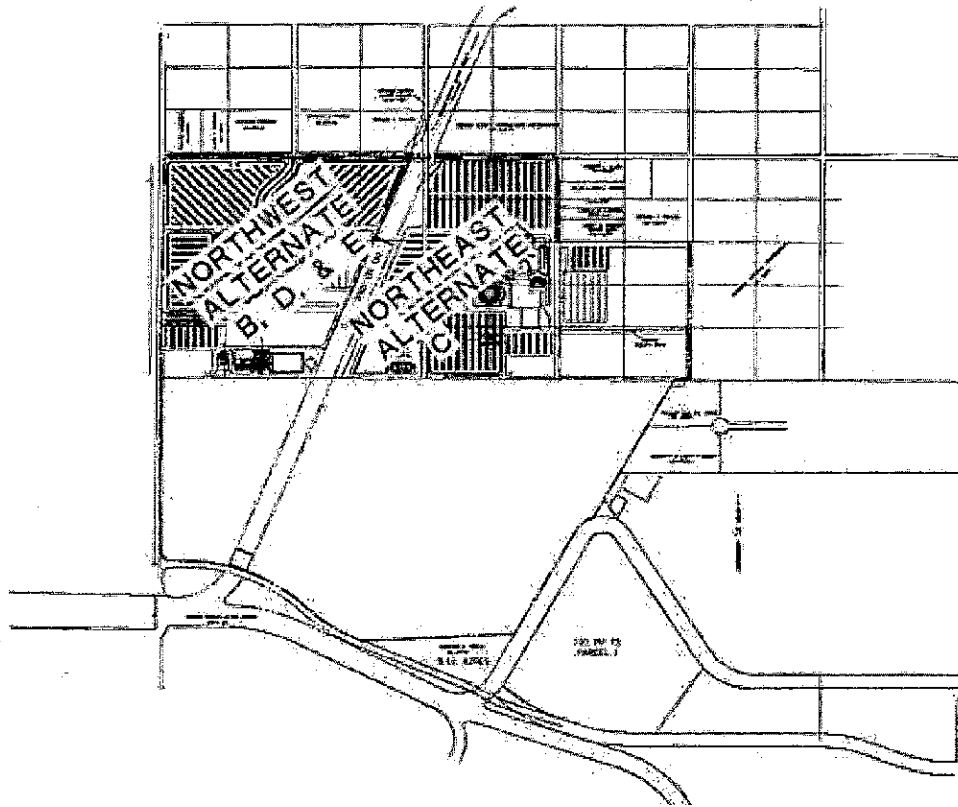

FIGURE 7

**SITE GRADING AND
STORM DRAINAGE (STONY POINT SITE)
PROPOSED GAMING FACILITY
FEDERATED INDIANS OF GRATON RANCHERIA
SONOMA COUNTY, CALIFORNIA**

INTRODUCTION

This report presents preliminary site grading and storm drainage plans for alternative development in Sonoma County near the southwest corner of Stony Point Road and Wilfred Avenue in Sonoma County, California. (See Figure 8, the Stony Point Site).

The plans were based upon preliminary architectural layouts B,C,D&E for two alternate site locations within the Stony Point Site. Architectural layouts B,D&E are alternate layouts for the northwest corner of the site and Layout C is for the northeast corner of the site. This report and associated plans were intended to provide information for the environmental analysis of the project. The final architectural design and site development plan for the project may require revisions to the plans presented in this report.

The Flood Insurance Rate Map entitled "Sonoma County, California (Unincorporated Areas) Community Panel Number 069375 0855B" designates a portion of the Stony Point Site as located within the 100 year floodplain of the Laguna de Santa Rosa and the Bellevue-Wilfred Flood Control Channel. (See Figure 9)

The grading and drainage plan incorporates fill to elevate the proposed Gaming Facility above the 100 year floodplain and creates a series of stormwater detention ponds to attenuate the increase in peak flow of the storm runoff created by the development of the project. The increase in peak flow is created by fill in the flood plain, increase in runoff created by increasing the impervious area and 300,000 gallons per day of tertiary treated effluent from the proposed onsite sanitary sewage treatment plant.

The project has been analyzed with four alternate layouts on two site locations. Both sites are in the northerly portion of the project and are depicted on Figures 10a-b,10c&10d.

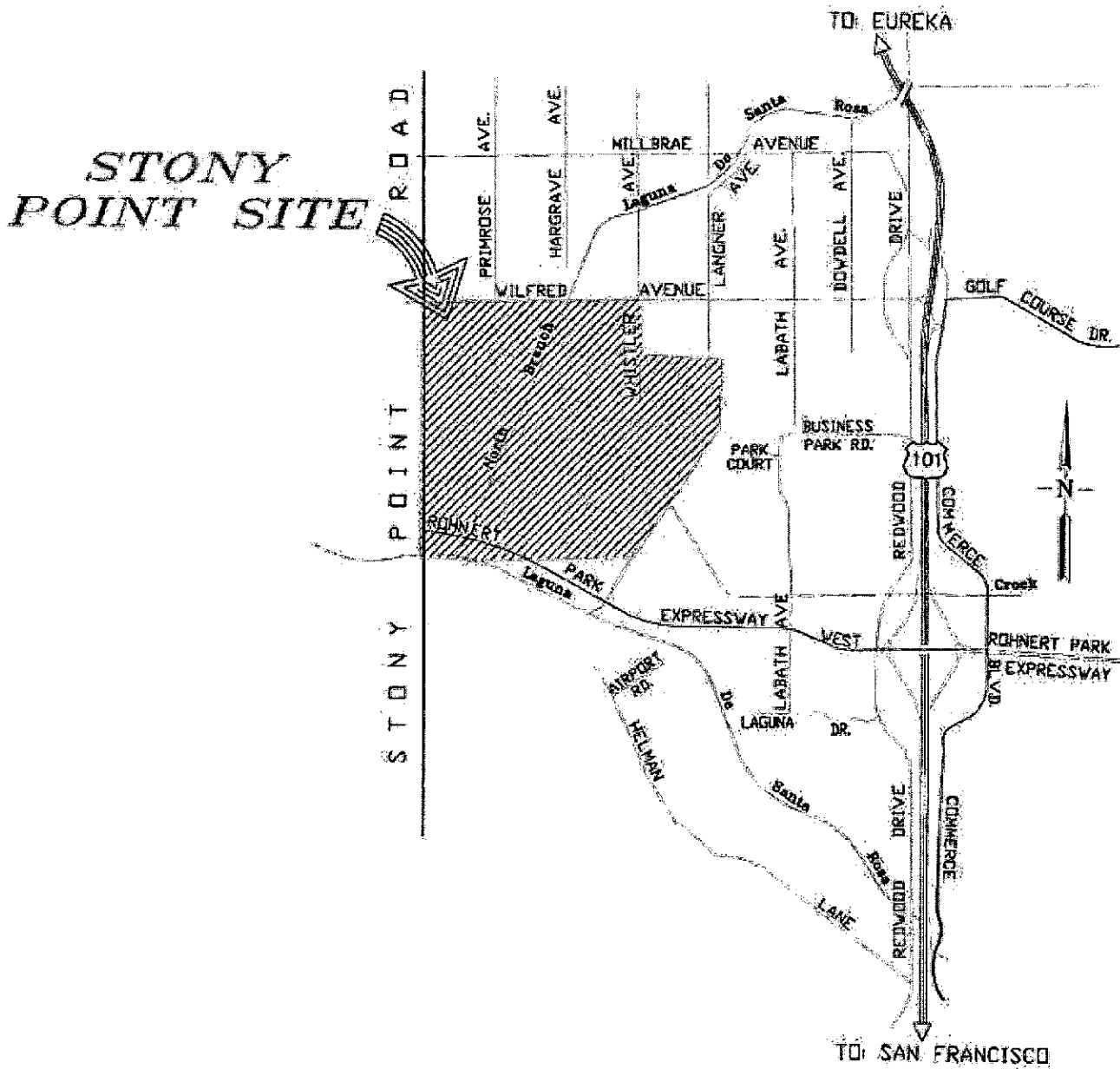

STONY POINT SITE BOUNDARY

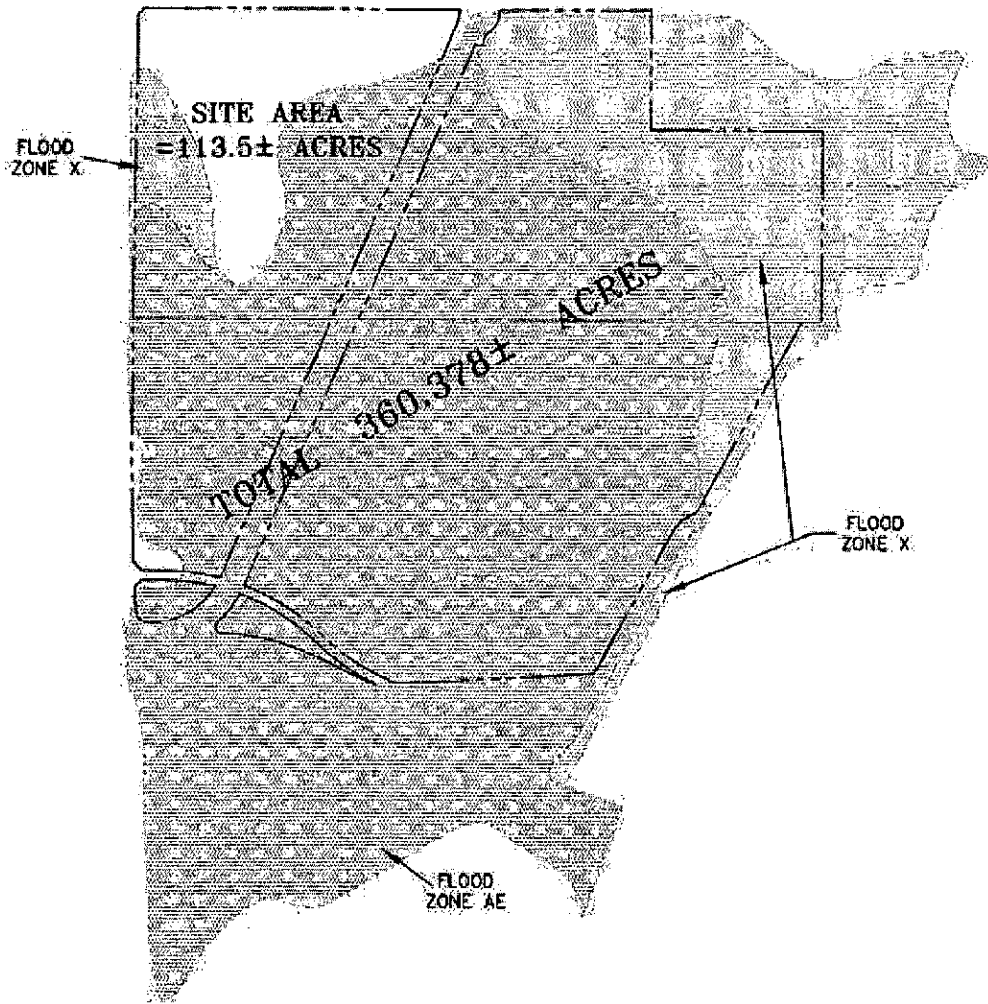

**FLOOD PLAIN BOUNDARY
STONY POINT SITE**

FIGURE 9



**ALTERNATE SITE LOCATIONS
LAYOUTS B&C**



ALTERNATE LAYOUT D

FIGURE 10c



ALTERNATE LAYOUT E

FIGURE 10d

EXISTING SITE DESCRIPTION

The site consists of approximately 360 acres of grazing and pastureland. The Stony Point Site is bounded by Wilfred Avenue on the north, Stony Point Road on the west, Rohnert Park Expressway on the south, and a mobile home park, business park, undeveloped property and four rural residential homes on the east.

The existing topography is relatively flat. The site slopes from Wilfred Avenue southerly to Rohnert Park Expressway at an average slope of 0.001 %.

The Bellevue-Wilfred Flood Control Channel flows southeasterly through the site from Wilfred Avenue to Rohnert Park Expressway and into the Laguna de Santa Rosa. Existing storm runoff from the site enters the Bellevue-Wilfred Channel through two 54" CMP culverts and five 24" CMP culverts (See Appendix C)

FLOODPLAIN ENCROACHMENT

A portion of the proposed gaming facility is located within Floodplain Zone AE as shown on the Flood Insurance Rate Map for Sonoma County. The flood plain elevations fall westerly across the site and vary from 89.5 to 88.

The proposed gaming facility will require placing fill in a portion of the floodplain. This report addresses two alternate site locations within the project boundary.

Utilizing the Floodplain boundary from the Flood Insurance Rate Map and a 1" = 200' scale existing topographic map prepared in October, 2003 the volume of flood plain encroachment was calculated. Table 3 lists the volume of storage displaced by the alternate site locations.

TABLE 3 – Floodplain Encroachment

SITE	VOLUME (Acre-Feet)
Northwest Corner	88
Northeast Corner	201

STORMWATER HYDROLOGY

A hydrologic investigation was performed to estimate the 100 year storm runoff for the pre and post development of the site for both alternative site plans.

The Haestad Pond Pack Software was utilized to develop Soil Conservation Service (SCS) unit hydrographs. The hydrographs were analyzed to determine the volume of storm drainage detention required.

Watershed area was calculated for each alternate site based upon the preliminary architectural site plans.

The soil type was identified by Geocon Consultants field investigation. The SCS curve numbers (CN) for the existing and developed site were determined utilizing the hydrologic soil groups as defined by the Natural Resource Conservation Service. Technical Release 55 (TR55) Table 2-2a and 2-2c were used to establish the CN values.

The time of concentration was assumed to be 0.5 hours for these calculations.

Rainfall-Intensity-Duration curve was generated from the Sonoma County Water Agency Flood Control Design Criteria Manual dated March 29, 1999.

The Rainfall Distribution Type IA was used based upon the approximate geographic boundaries for SCS rainfall distribution as presented in Pond Pack 6.0 User's Guide.

The parameters used are summarized in Table 4.

The SCS Unit Hydrographs and the associated calculations are included with this report as Appendix A.

**Table-4
Hydrologic
Parameters**

Parameter	Value Northwest	Value Northeast	Source
Water Shed Area	79.2+ Acres	100.4+ Acres	Measured on topographic map of the Project Site.
Runoff Curve Number	<p align="center">79 Undeveloped Site</p> <p align="center">94 Developed Site</p>	<p align="center">78 Undeveloped Site</p> <p align="center">95 Developed Site</p>	Curve numbers were estimated using the soils classified by the Natural Resource Conservation, the field investigations performed by GEOCON Consultants, Inc. and Tables 2-2a, Table 2-2c of 210-VI-TR-55, Second Edition were used (Figures 5, 6 & 7).
Time of Concentration	0.5 Hours	0.5 Hours	Assumption is made per the type of soil and as the existing conditions.
Rainfall Intensities	1.68 inches / hour	1.68 inches / hour	Sonoma County Water Agency, Flood design Criteria Dated March 1999.
Rain Fall Distribution	SCS Type -IA	SCS Type -IA	As per the hydrological boundaries.

STORMWATER DETENTION ANALYSIS

To mitigate offsite impacts, the stormwater drainage system for the proposed project is designed to limit the peak flow from the developed site to predevelopment peak flows.

To accomplish this, storm water detention has been incorporated into the southerly portions of the project site. The size of the basins vary based upon which alternate site plan will be implemented. The basin size takes into account the increase in runoff created by increased impervious surfaces, encroachment of fill into the flood plain and the potential for 300,000 gallons per day of treated waste water effluent discharged into the Bellevue-Wilfred Flood Control Channel.

The increase in volumes due to development and storage volumes for the site are shown in Table 5.

Although the proposed development of the project increases runoff and peak flow rates, the detention basins temporarily stores the runoff to limit the peak flow. The peak flow from the detention basins will be metered through the existing 54" CMP culverts to pre-project levels. A preliminary grading plan for the detention basins is included as Appendix B.

TABLE 5 – Increased Volumes & Storage Volumes

<u>INCREASED RUN-OFF</u>	Northwest	Northeast
INCREASE DUE TO DEVELOPMENT	11 AcFt	15 AcFt
INCREASE DUE TO FLOODPLAIN ENCROACHMENT	88 AcFt	201 AcFt
INCREASE DUE TO EFFLUENT DISCHARGE	1 AcFt	1 AcFt
TOTAL STORAGE REQUIRED	100.0 AcFt	217.0 AcFt
<u>STORAGE VOLUMES</u>		
SOUTHWEST DRAINAGE AREA	12.5 AcFt	0 AcFt
SOUTHEAST DRAINAGE AREA	101.0 AcFt	356.0 AcFt
TOTAL STORAGE PROVIDED	113.5 AcFt	356.0 AcFt

DRAINAGE IMPROVEMENTS

The development of the project will include several storm drainage improvements. The following sections describe the recommended improvements.

Overland Drainage Release

As the project is developed, an overland drainage will be created to allow property northerly of Wilfred Avenue to drain under overflow conditions. The overland drainage release will be around the perimeter of the sites and is shown on Figures 11 and 12.

Detention Basin Grading

Figures 13 & 14 show the proposed locations and volumes for the detention basins. A preliminary grading plan is included in Appendix B that provides a more detailed grading analysis. The construction of the detention basins will be coordinated with the biological consultant to minimize wetland and habitat disturbance and to allow for creation of additional habitat areas.

Building and Parking Lot Grading and Drainage

The finished floor of the building will be elevated above the FEMA 100 year flood plain elevations by incorporating fill from the detention basin excavation. It is estimated that 150,000 cubic yards of earthwork will be required for layouts B, D & E and 350,000 cubic yards of earthwork for layout C. It is anticipated that the onsite grading will balance based upon the detention basin excavation and additional site borrowing if necessary. Onsite drainage systems will consist of an underground piped drainage system, as well as, sheet flow to grassy swales. Inlets will be placed at appropriate intervals to capture runoff and convey to the detention basins.

Roof leaders should be connected directly to the pipe system and parking lots should be constructed with a 1% minimum slope and 5% maximum slope toward the inlets.



**NORTHWEST
OVERLAND DRAINAGE RELEASE**

FIGURE 11

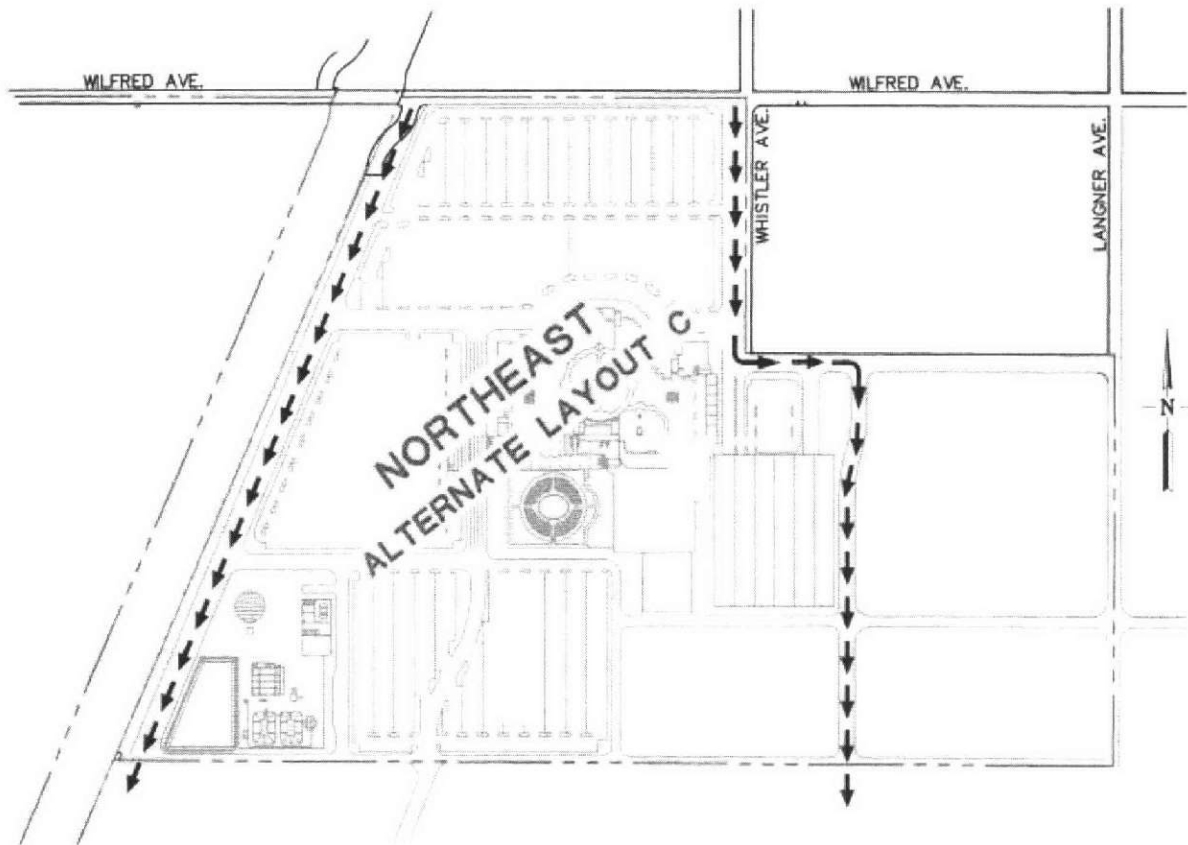

NORTHEAST OVERLAND DRAINAGE RELEASE

FIGURE 12

LAYOUTS B, D, AND E
NORTHWEST STONY POINT SITE
STORM DRAINAGE
DETENTION BASIN
LOCATION AND VOLUME

STORM DRAINAGE
DETENTION

12 Ac Ft
STORAGE DUE TO
DEVELOPMENT

88 Ac Ft
STORAGE DUE TO FLOOD
PLAIN ENCROACHMENT

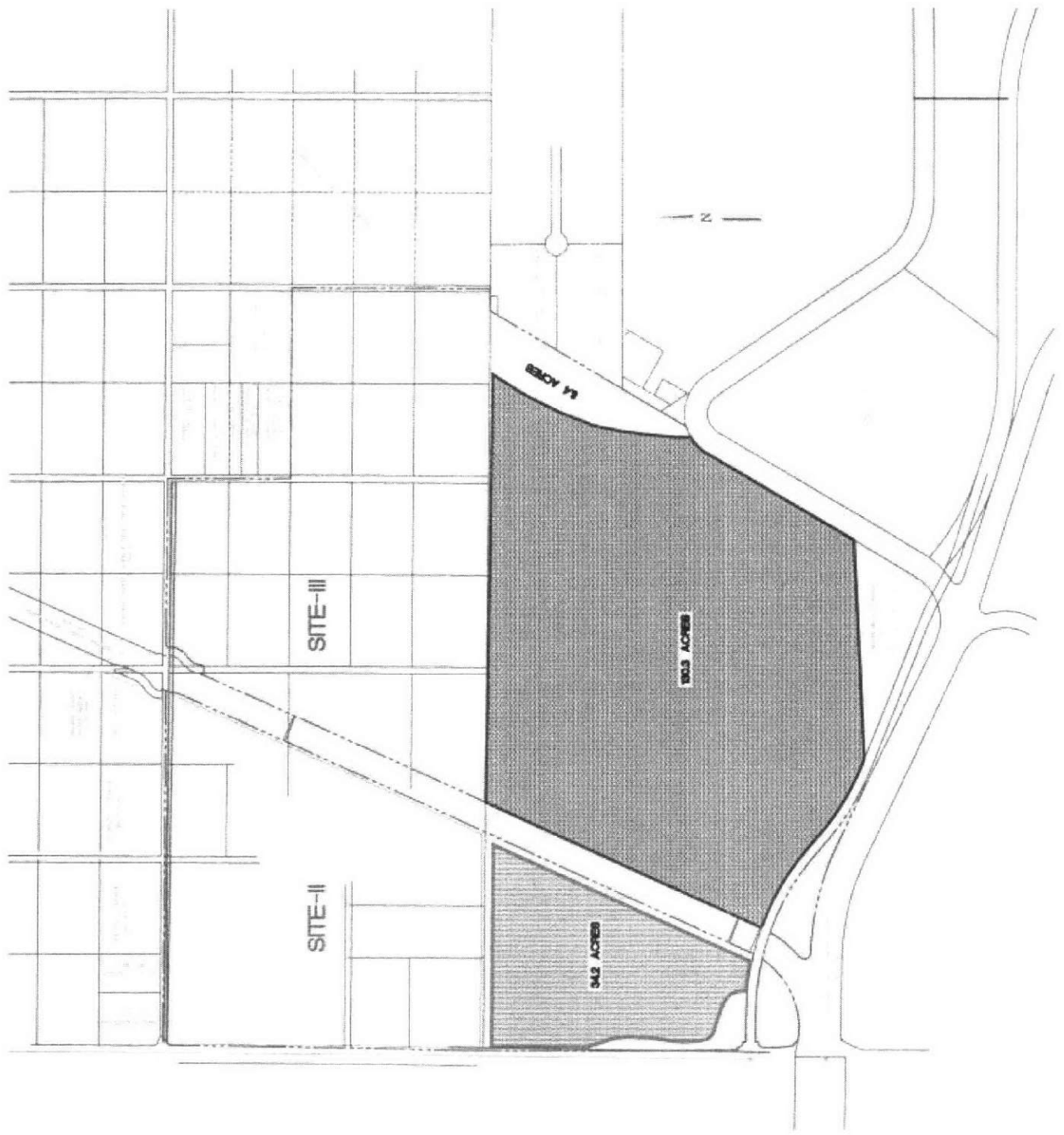

LAYOUT C
NORTHEAST STONY POINT SITE
STORM DRAINAGE
DETENTION BASIN
LOCATION AND VOLUME

STORM DRAINAGE
DETENTION

217 Ac Ft
STORAGE DUE TO FLOOD
PLAIN ENCROACHMENT
AND
STORAGE DUE TO
DEVELOPMENT



AC20081\Mapset\January-08-addition\Graphics\1 & 8 - Storm Drain\2008\Operation Sheet 20a.dwg

EROSION CONTROL

An erosion control plan will be developed with the primary intent to decrease pollutants entering the water columns, with a secondary intent of trapping pollutants before they exit the site.

A Storm Water Pollution Prevention Plan should be prepared as part of the project to provide a level of protection equivalent to full compliance with the Statewide General Construction Activities Storm Water Permit adopted by the Storm Water Resources Control Board.

A partial list of Best Management Practices (BMP's) is included as Appendix D.

SUMMARY

The impacts associated with floodplain encroachment, increase in storm runoff as a result of development and the potential discharge of 300,000 gallons per day of tertiary treated effluent can be mitigated through the creation of detention basins on the southerly portion of the site. Layouts B through E would require a maximum of 12 acre feet of storage on the southwest quadrant and 217 acre feet on the southeast quadrant of the property.

The excavation associated with the detention ponds would create adequate fill material to raise the finish floor approximately 2 feet above the 100 year flood plain elevation.

SECTION-III Lakeville Site

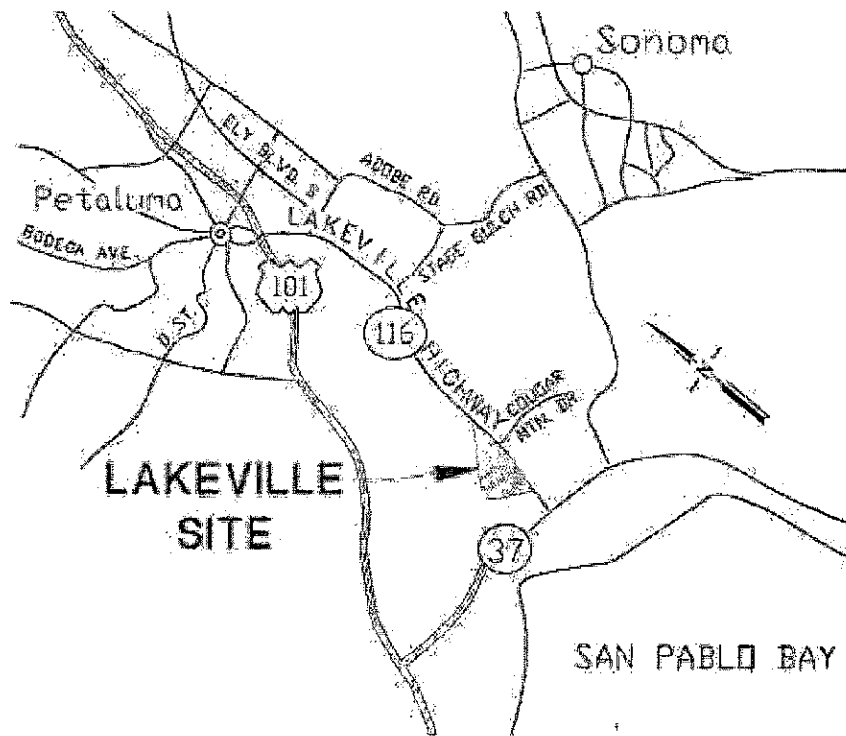

FIGURE 15

**SITE GRADING AND
STORM DRAINAGE (LAKEVILLE SITE)
PROPOSED GAMING FACILITY
FEDERATED INDIANS OF GRATON RANCHERIA
SONOMA COUNTY, CALIFORNIA**

INTRODUCTION

This report presents preliminary site grading and storm drainage plan for the proposed Gaming Facility in Sonoma County on Lakeville Highway in Sonoma County, California. (See Figure 16, Lakeville Site)

The plan is based upon preliminary architectural layout F. This report and associated plans were intended to provide information for the environmental analysis of the project. The final architectural design and site development plan for the project may require revisions to the plans presented in this report.

The Flood Insurance Rate Map entitled "Sonoma County, California (Unincorporated Areas) Community Panel Number 060375 1015B" designates a portion of the Lakeville Site as located within the 100-year floodplain. (See Figure 17)

The grading and drainage plan incorporates fill to elevate the proposed Gaming Facility above the 100 year flood plain and creates a series of stormwater detention ponds to attenuate the increase in peak flow of the storm runoff created by the development of the project. The increase in peak flow is created by fill in the flood plain, increase in runoff created by increasing the impervious area and approximately 300,000 gallons per day of tertiary treated effluent from the proposed onsite sanitary sewage treatment plant.

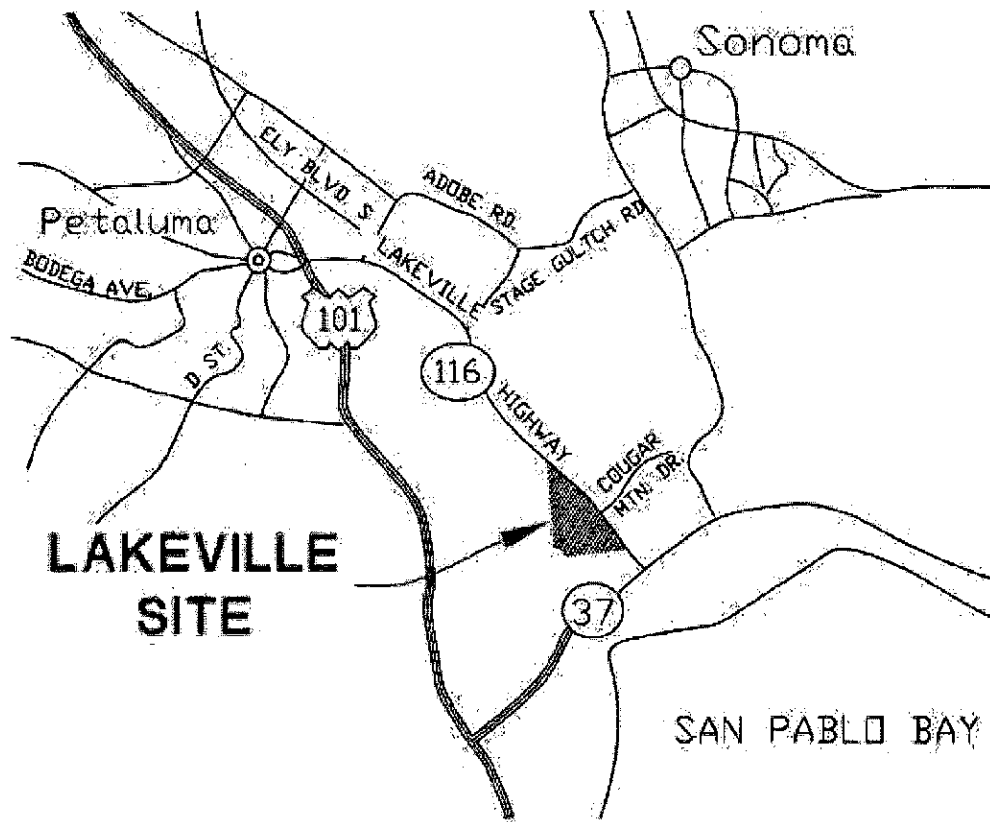

LAKEVILLE SITE BOUNDARY & LOCATION MAP

NO SCALE

FIGURE 16

EXISTING SITE DESCRIPTION

The Lakeville Site consists of approximately 242.48 acres of grazing and pastureland located on the west side of Lakeville Highway

The existing topography is relatively flat and the site slopes from Lakeville Highway to the westerly end of the property at an average slope of 1.5%.

The site accepts runoff from the property on the easterly side of Lakeville Highway through six culverts that run under the Lakeville Highway. The culverts drain into earth swales that generally travel westerly. The swales disappear approximately 450 feet into the site. At that point they change to sheet flow to the westerly corner of the property.

FLOODPLAIN ENCROACHMENT

A portion of the proposed gaming facility is located within Floodplain Zone AE as shown on the Flood Insurance Rate Map for Sonoma County. The flood plain 7.0 elevation falls westerly across the site.

The proposed gaming facility will require placing fill in a portion of the flood plain. Utilizing the Floodplain boundary from the Flood Insurance Rate Map and a 1" = 200' scale existing topographic map prepared in October, 2003 the volume of flood plain encroachment was calculated. Table 6 lists the volume of storage displaced by the site location.

TABLE 6 – Floodplain Encroachment

SITE	VOLUME (Acre-Feet)
Lakeville Site	110

STORMWATER HYDROLOGY

A hydrologic investigation was performed to estimate the 100-year storm runoff for the pre and post development of the site for both alternative site plans.

The Haestad Pond Pack Software was utilized to develop Soil Conservation Service (SCS) unit hydrographs. The hydrographs were analyzed to determine the volume of storm drainage detention required.

Watershed area was calculated for the site based upon the preliminary architectural site plans.

The soil type was identified by Geocon Consultants field investigation. The SCS curve numbers (CN) for the existing and developed site were determined utilizing the hydrologic soil groups as defined by the Natural Resource Conservation Service. Technical Release 55 (TR55) Table 2-2a and 2-2c were used to establish the CN values.

The time of concentration was assumed to be 0.5 hours for these calculations.

Rainfall-Intensity-Duration curve was generated from the Sonoma County Water Agency Flood Control Design Criteria Manual dated March 29, 1999.

The Rainfall Distribution Type IA was used based upon the approximate geographic boundaries for SCS rainfall distribution as presented in Pond Pack 6.0 User's Guide.

The SCS Unit Hydrographs and the associated calculations are included with this report as appendix A.

STORMWATER DETENTION ANALYSIS

To mitigate offsite impacts, the stormwater drainage system for the proposed project is designed to limit the peak flow from the developed site to predevelopment peak flows.

To accomplish this, storm water detention has been incorporated into the westerly portions of the Lakeville Site. The storage pond size takes into account the increase in runoff created by increased impervious surfaces. The excavation on the westerly side below 7 feet elevation takes into account the increase in runoff created by encroachment of fill into the flood plain and the potential for 300,000 gallons per day of treated waste water effluent discharge.

The increase in volumes due to development and storage volumes for the site are shown in Table 7.

Although the proposed development of the project increases runoff and peak flow rates, the detention basins temporarily stores the runoff to limit the peak flow. The peak flow from the detention basins will be metered to pre-project levels. A preliminary grading plan for the detention basins is included as Appendix B.

TABLE 7 – Increased Volumes & Storage Volumes

INCREASED RUN-OFF

INCREASE DUE TO DEVELOPMENT = 11 AcFt

INCREASE DUE TO FLOODPLAIN ENCROACHMENT = 110 AcFt

INCREASE DUE TO EFFLUENT DISCHARGE = 1 AcFt

TOTAL STORAGE REQUIRED = 122.0 AcFt

STORAGE VOLUMES

STORAGE POND A, B & C = 11.0 AcFt

EXCAVATING BELOW 7.0 FEET ELEVATION = 141.0 AcFt

TOTAL STORAGE PROVIDED = 152.0 AcFt

DRAINAGE IMPROVEMENTS

The development of the project will include several storm drainage improvements. The following sections describe the recommended improvements.

Overland Drainage Release

An overland drainage release has been incorporated into the project design to enable the property east of Lakeville Highway to continue to drain through the Lakeville Site. The overland drainage release also allows the building to be protected during peak storm runoff events. The overland drainage release is shown on Figure 18.

Detention Basin Grading

Figure 19 shows the proposed locations and volumes for the detention basins. A preliminary grading plan is included in Appendix B that provides a more detailed grading analysis. The construction of the detention basins will be coordinated with the biological consultant to minimize wetland and habitat disturbance and to allow for creation of additional habitat areas.

Building and Parking Lot Grading and Drainage

The finished floor of the building will be elevated above the FEMA 100 year flood plain elevations by incorporating fill from the detention basin excavation. The total volume of earthwork is estimated to be 404,000 CYD to develop the site. Onsite excavation will yield approximately 338,000 CYD of fill material. An additional 66,000 CYD of material will need to be imported to the site to achieve the design grades. The import material is available locally from two nearby quarries. The fill can be imported with 160-200 trucks per day with each truck carrying 12 cubic yards of dirt. It is estimated that the duration of the importation of fill will be approximately 1 month. Onsite drainage systems will consist of an underground piped drainage system, as well as, sheet flow to grassy swales. Inlets will be placed at appropriate intervals to capture runoff and convey to the detention basins.

Roof leaders should be connected directly to the pipe system and parking lots should be constructed with a 1% minimum slope and 5% maximum slope toward the inlets.

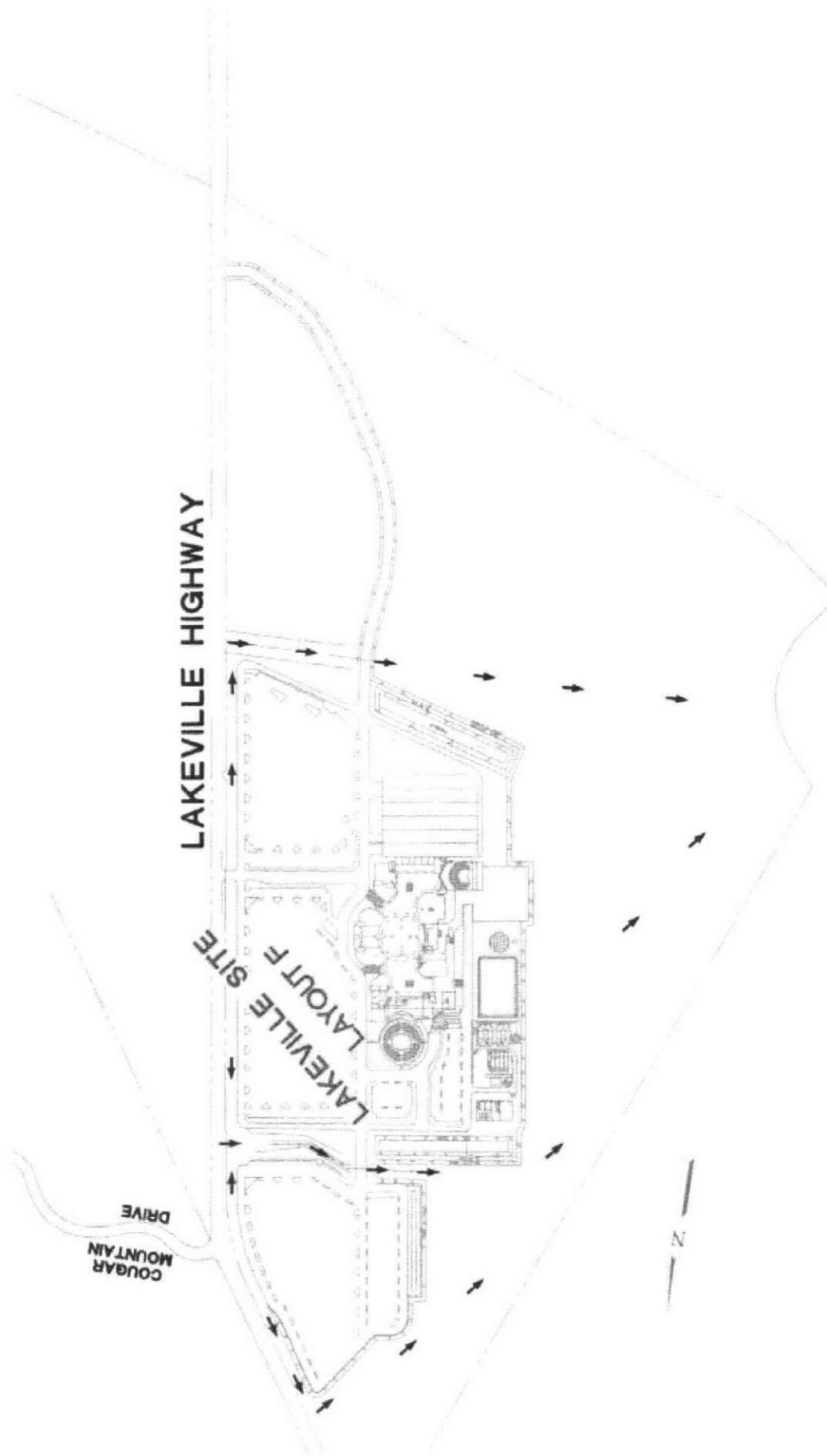

**LAKEVILLE SITE
LAYOUT F
OVERLAND DRAINAGE RELEASE**

A03568\Figart-Januar 7-08-Addition\Section IV - Lakeville Site\Overland Drainage Release.dwg

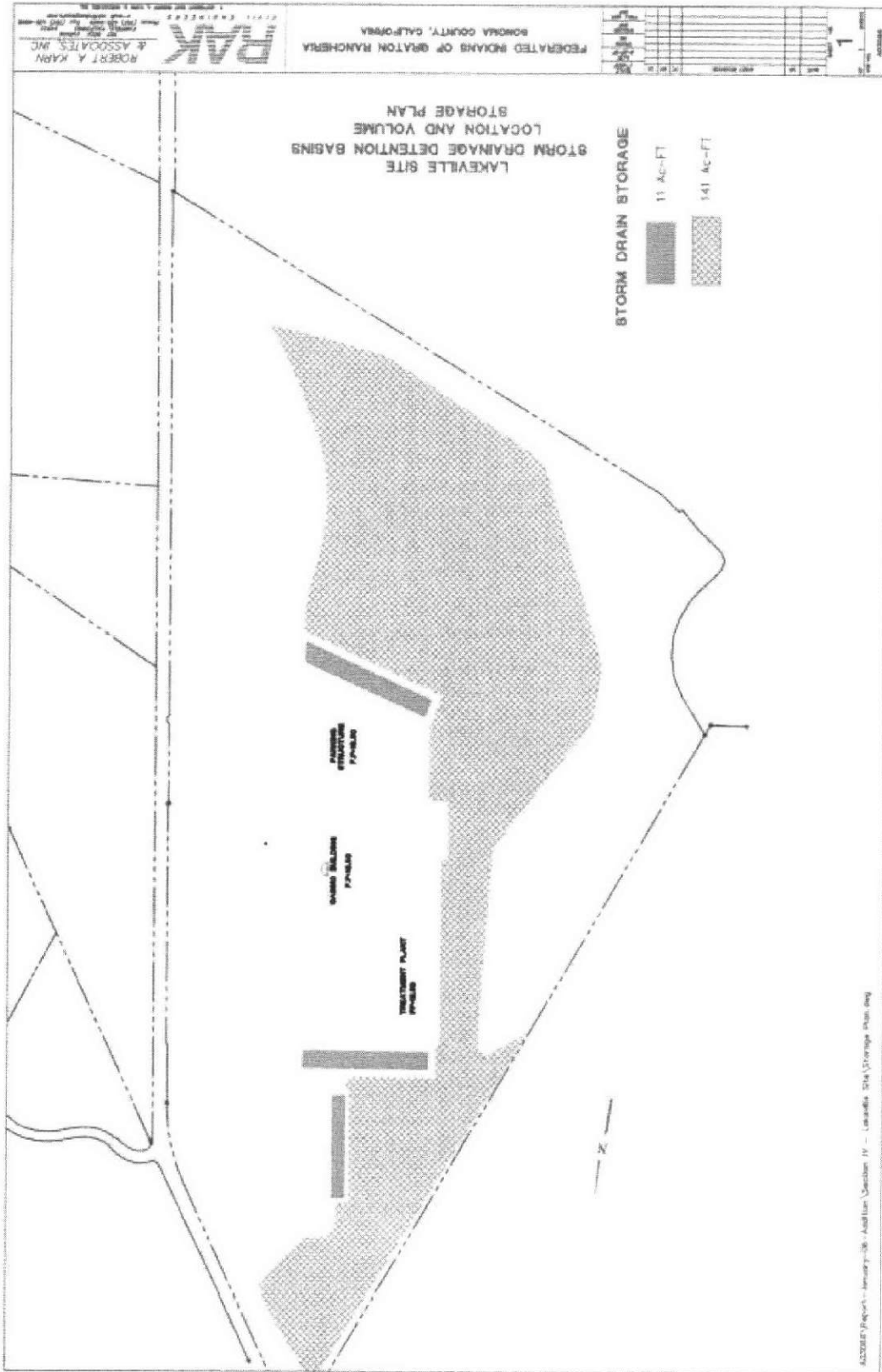

FIGURE 19

EROSION CONTROL

An erosion control plan will be developed with the primary intent to decrease pollutants entering the water columns, with a secondary intent of trapping pollutants before they exit the site.

A Storm Water Pollution Prevention Plan should be prepared as part of the project to provide a level of protection equivalent to full compliance with the Statewide General Construction Activities Storm Water Permit adopted by the Storm Water Resources Control Board.

A partial list of Best Management Practices (BMP's) is included as Appendix D.

SUMMARY

The impacts associated with floodplain encroachment, increase in storm runoff as a result of development and the potential discharge of 300,000 gallons per day of tertiary treated effluent can be mitigated through the creation of storage ponds and excavating the site below flood plain elevation the westerly portion of the site.

The onsite excavation associated with the project will generate most of the required fill material. An additional 66,000 CYD of material will need to be imported to the site to achieve the design grades.

APPENDIX A

SCS Unit Hydrographs and Calculations

INDEX

1. Reference and Intensity Duration Curves & Tables

2. Wilfred Site (Site-I) Calculations

3. Stony Point Site – Northwest Corner (Site-II) Calculations

4. Stony Point Site – Northeast Corner (Site-III) Calculations

5. Lakeville Site (Site-IV) Calculations

References and Intensity Duration Curves & Tables

Type.... Time-Depth Curve
 Name.... Depth Tbl 100YR

File.... S:\HAESTAD\PPK6\100-YR.RNF
 Title... SONOMA COUNTY 100-YR

SYNTHETIC CUMULATIVE RAINFALL(in)
 Output Time increment = .0480 hrs
 Time on left represents time for first value in each row.

Time hrs						
.0000	.0000	.0041	.0083	.0126	.0169	
.2400	.0212	.0256	.0300	.0345	.0391	
.4800	.0437	.0483	.0530	.0578	.0626	
.7200	.0674	.0723	.0773	.0823	.0873	
.9600	.0924	.0976	.1028	.1081	.1134	
1.2000	.1187	.1241	.1296	.1351	.1407	
1.4400	.1463	.1519	.1576	.1634	.1692	
1.6800	.1751	.1810	.1870	.1930	.1990	
1.9200	.2052	.2113	.2176	.2190	.2206	
2.1600	.2223	.2241	.2260	.2280	.2301	
2.4000	.2322	.2345	.2369	.2393	.2419	
2.6400	.2446	.2473	.2502	.2531	.2562	
2.8800	.2593	.2625	.2659	.2693	.2728	
3.1200	.2765	.2802	.2840	.2879	.2919	
3.3600	.2960	.3002	.3045	.3089	.3134	
3.6000	.3180	.3227	.3275	.3324	.3374	
3.8400	.3424	.3476	.3529	.3583	.3637	
4.0800	.3693	.3749	.3807	.3865	.3925	
4.3200	.3985	.4047	.4109	.4172	.4237	
4.5600	.4302	.4368	.4436	.4504	.4573	
4.8000	.4643	.4714	.4786	.4859	.4933	
5.0400	.5008	.5084	.5161	.5239	.5318	
5.2800	.5397	.5478	.5560	.5643	.5726	
5.5200	.5811	.5897	.5983	.6071	.6159	
5.7600	.6249	.6339	.6431	.6523	.6616	
6.0000	.6711	.6806	.6902	.6999	.7098	
6.2400	.7197	.7297	.7398	.7500	.7603	
6.4800	.7707	.7812	.7918	.8025	.8133	
6.7200	.8241	.8351	.8462	.8574	.8686	
6.9600	.8800	.8915	.8955	.8998	.9044	
7.2000	.9092	.9142	.9195	.9250	.9307	
7.4400	.9367	.9430	.9494	.9562	.9631	
7.6800	.9703	.9778	.9855	.9934	1.0016	
7.9200	1.0100	1.0187	1.0276	1.0367	1.0461	
8.1600	1.0557	1.0656	1.0757	1.0860	1.0966	
8.4000	1.1075	1.1185	1.1298	1.1414	1.1532	
8.6400	1.1653	1.1775	1.1901	1.2028	1.2159	
8.8800	1.2291	1.2426	1.2505	1.2505	1.2505	
9.1200	1.2505	1.2505	1.2505	1.2505	1.2505	
9.3600	1.2509	1.2522	1.2544	1.2574	1.2613	
9.6000	1.2660	1.2716	1.2781	1.2855	1.2937	
9.8400	1.3028	1.3127	1.3235	1.3352	1.3477	
10.0800	1.3611	1.3753	1.3904	1.4064	1.4233	
10.3200	1.4410	1.4596	1.4790	1.4993	1.5205	
10.5600	1.5425	1.5654	1.5892	1.6138	1.6393	

Type.... Time-Depth Curve
Name.... Depth Tbl 100YR

File.... S:\HAESTAD\PPK6\100-YR.RNF
Title... SONOMA COUNTY 100-YR

SYNTHETIC CUMULATIVE RAINFALL(in)
Output Time increment = .0480 hrs
Time on left represents time for first value in each row.

Time hrs					
10.8000	1.6656	1.6928	1.7209	1.7499	1.7797
11.0400	1.7942	1.8037	1.8164	1.8324	1.8515
11.2800	1.8739	1.8996	1.9284	1.9605	1.9958
11.5200	2.0343	2.0484	2.0719	2.1046	2.1467
11.7600	2.1980	2.2310	2.2861	2.3347	2.4100
12.0000	2.5833	2.7566	2.8803	2.9540	2.9835
12.2400	3.0276	3.0701	3.1168	3.1542	3.1823
12.4800	3.2011	3.2159	3.2528	3.2865	3.3169
12.7200	3.3442	3.3682	3.3890	3.4065	3.4209
12.9600	3.4320	3.4399	3.4701	3.4995	3.5280
13.2000	3.5556	3.5824	3.6083	3.6334	3.6576
13.4400	3.6809	3.7034	3.7250	3.7457	3.7656
13.6800	3.7846	3.8027	3.8200	3.8364	3.8520
13.9200	3.8667	3.8805	3.8935	3.9056	3.9168
14.1600	3.9272	3.9367	3.9453	3.9531	3.9600
14.4000	3.9660	3.9712	3.9755	3.9790	3.9816
14.6400	3.9833	3.9842	3.9842	3.9842	3.9842
14.8800	3.9842	3.9842	3.9842	3.9842	3.9842
15.1200	3.9978	4.0112	4.0243	4.0372	4.0498
15.3600	4.0622	4.0744	4.0863	4.0980	4.1095
15.6000	4.1207	4.1316	4.1423	4.1528	4.1630
15.8400	4.1730	4.1828	4.1923	4.2015	4.2105
16.0800	4.2193	4.2279	4.2362	4.2442	4.2520
16.3200	4.2596	4.2669	4.2740	4.2808	4.2874
16.5600	4.2938	4.2999	4.3058	4.3114	4.3168
16.8000	4.3220	4.3269	4.3315	4.3360	4.3401
17.0400	4.3491	4.3606	4.3719	4.3831	4.3942
17.2800	4.4052	4.4162	4.4270	4.4378	4.4484
17.5200	4.4589	4.4694	4.4797	4.4900	4.5001
17.7600	4.5102	4.5202	4.5300	4.5398	4.5495
18.0000	4.5591	4.5685	4.5779	4.5872	4.5964
18.2400	4.6055	4.6145	4.6234	4.6322	4.6409
18.4800	4.6495	4.6580	4.6664	4.6747	4.6830
18.7200	4.6911	4.6991	4.7071	4.7149	4.7226
18.9600	4.7303	4.7378	4.7453	4.7526	4.7599
19.2000	4.7670	4.7741	4.7810	4.7879	4.7947
19.4400	4.8014	4.8079	4.8144	4.8208	4.8271
19.6800	4.8333	4.8394	4.8454	4.8513	4.8571
19.9200	4.8628	4.8684	4.8739	4.8793	4.8846
20.1600	4.8898	4.8950	4.9000	4.9049	4.9098
20.4000	4.9145	4.9191	4.9237	4.9281	4.9325
20.6400	4.9367	4.9409	4.9450	4.9489	4.9528
20.8800	4.9566	4.9602	4.9638	4.9673	4.9707
21.1200	4.9740	4.9772	4.9802	4.9832	4.9861
21.3600	4.9889	4.9917	4.9943	4.9968	4.9992
21.6000	5.0015	5.0037	5.0059	5.0079	5.0098

Type.... Time-Depth Curve
Name.... Depth Tbl 100YR

File.... S:\HAESTAD\PPK6\100-YR.RNF
Title... SONOMA COUNTY 100-YR

SYNTHETIC CUMULATIVE RAINFALL(in)
Output Time increment = .0480 hrs
Time on left represents time for first value in each row.

Time hrs					
21.8400	5.0117	5.0134	5.0150	5.0166	5.0196
22.0800	5.0258	5.0320	5.0381	5.0441	5.0501
22.3200	5.0560	5.0619	5.0678	5.0735	5.0793
22.5600	5.0850	5.0906	5.0962	5.1017	5.1072
22.8000	5.1126	5.1180	5.1234	5.1286	5.1339
23.0400	5.1390	5.1442	5.1493	5.1543	5.1593
23.2800	5.1642	5.1691	5.1739	5.1787	5.1834
23.5200	5.1881	5.1927	5.1973	5.2018	5.2062
23.7600	5.2107	5.2150	5.2193	5.2236	5.2278
24.0000	5.2320				

Type.... I-D-F Table
Name.... IDF tbl 100YR

File.... S:\HAESTAD\PPK6\SONOMA.IDF
Title... SONOMA COUNTY 100-YR

Rainfall-Intensity-Duration Curve

Time, hrs	Intens., in/hr
.1167	3.6100
.1667	2.9800
.3300	2.0900
.5000	1.6800
1.0000	1.1750
2.0000	.8250
6.0000	.4500
10.0000	.3450
20.0000	.2400
24.0000	.2180

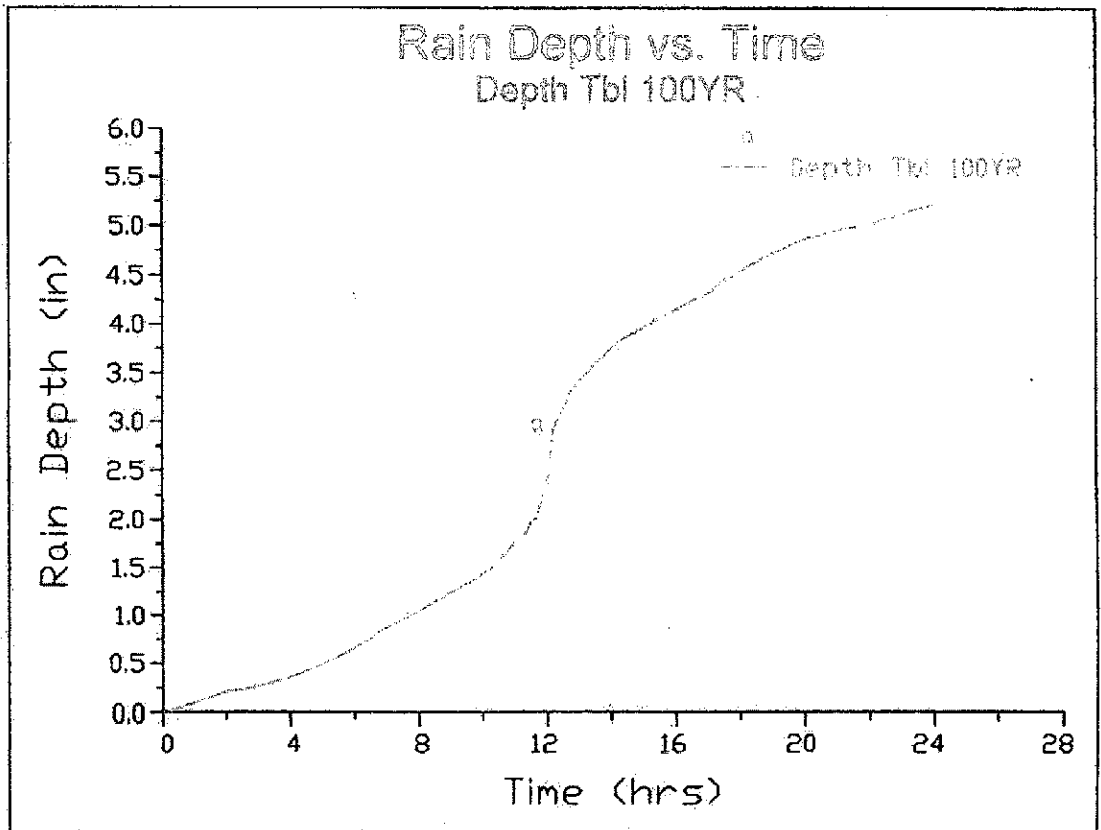
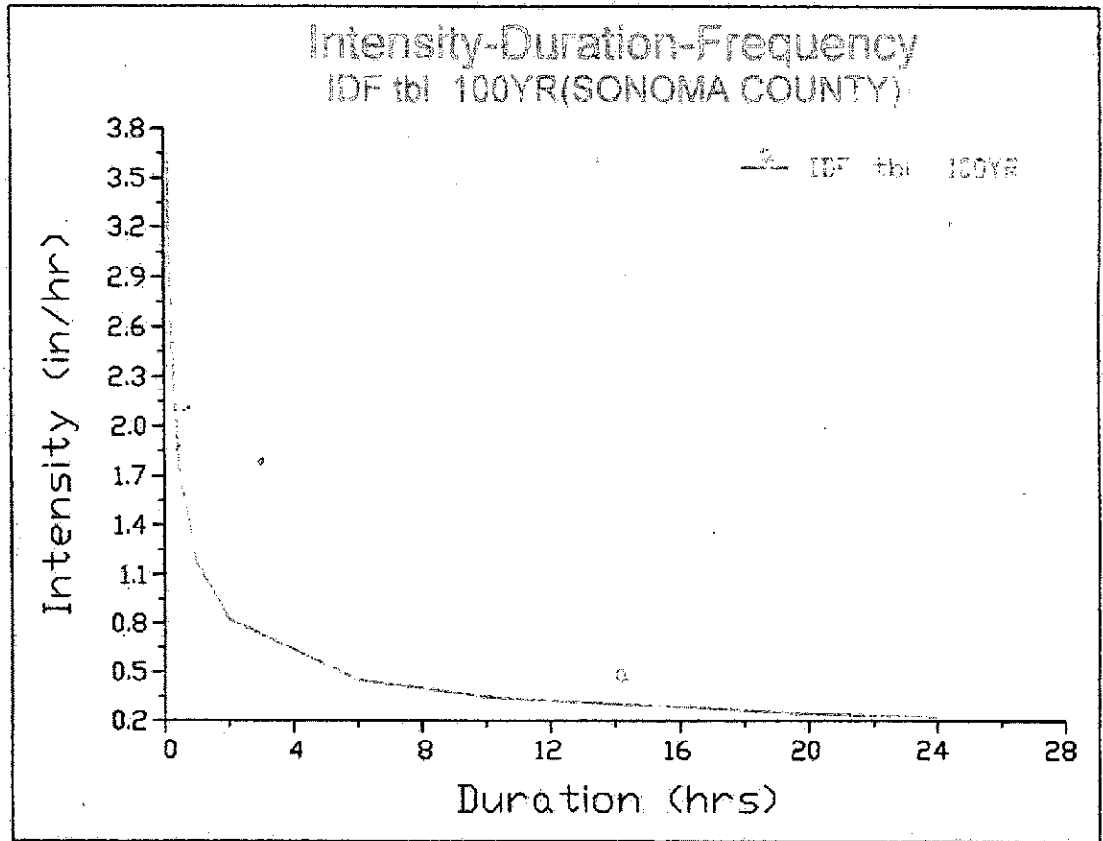

SCS UNIT HYDROGRAPH METHOD
(Computational Notes)

DEFINITION OF TERMS: -----

- At = Total area (acres): $At = Ai + Ap$
Ai = Impervious area (acres)
Ap = Pervious area (acres)
CNI = Runoff curve number for impervious area
CNP = Runoff curve number for pervious area
floss = f loss constant infiltration (depth/time)
dt = Computational increment (duration of unit excess rainfall)
Default dt is smallest value of $0.1333Tc$, rtm, and th
(Smallest dt is then adjusted to match up with Tp)
UDdt = User specified override computational main time increment
(only used if UDdt is $\Rightarrow .1333Tc$)
D(t) = Point on distribution curve (fraction of P) for time step t
K = $2 / (1 + (Tr/Tp))$: default K = 0.75: (for $Tr/Tp = 1.67$)
Ks = Hydrograph shape factor
= Unit Conversions * K:
= $((1hr/3600sec) * (1ft/12in) * ((5280ft)**2/sq.mi)) * K$
Default Ks = $645.333 * 0.75 = 484$
Lag = Lag time from center of excess runoff (dt) to Tp: $Lag = 0.6Tc$
P = Total precipitation depth, inches
Pa(t) = Accumulated rainfall at time step t
Pi(t) = Incremental rainfall at time step t
qp = Peak discharge (cfs) for lin. runoff, for 1hr, for 1 sq.mi.
= $(Ks * A * Q) / Tp$ (where Q = lin. runoff, A=sq.mi.)
Qu(t) = Unit hydrograph ordinate (cfs) at time step t
Q(t) = Final hydrograph ordinate (cfs) at time step t
Rai(t) = Accumulated runoff (inches) at time step t for impervious area
Rap(t) = Accumulated runoff (inches) at time step t for pervious area
Rii(t) = Incremental runoff (inches) at time step t for impervious area
Rip(t) = Incremental runoff (inches) at time step t for pervious area
R(t) = Incremental weighted total runoff (inches)
Rtm = Time increment for rainfall table (.RNF file)
Si = S for impervious area: $Si = (1000/CNi) - 10$
Sp = S for pervious area: $Sp = (1000/CNp) - 10$
t = Time step (row) number
Tc = Time of concentration
Tb = Time (hrs) of entire unit hydrograph: $Tb = Tp + Tr$
Tp = Time (hrs) to peak of a unit hydrograph: $Tp = (dt/2) + Lag$
Tr = Time (hrs) of receding limb of unit hydrograph: Tr = ratio of Tp

SCS UNIT HYDROGRAPH METHOD
(Computational Notes)

PRECIPITATION: -----

Column (1): Time for time step t
Column (2): D(t) = Point on distribution curve for time step t
Column (3): Pi(t) = Pa(t) - Pa(t-1): Col.(4) - Preceding Col.(4)
Column (4): Pa(t) = D(t) x P: Col.(2) x P

PERVIOUS AREA RUNOFF (using SCS Runoff CN Method) -----

Column (5): Rap(t) = Accumulated pervious runoff for time step t
If (Pa(t) is <= 0.2Sp) then use: Rap(t) = 0.0
If (Pa(t) is > 0.2Sp) then use:
$$Rap(t) = (Col.(4) - 0.2Sp) ** 2 / (Col.(4) + 0.8Sp)$$

Column (6): Rip(t) = Incremental pervious runoff for time step t
$$Rip(t) = Rap(t) - Rap(t-1)$$

Rip(t) = Col.(5) for current row - Col.(5) for preceding row.

IMPERVIOUS AREA RUNOFF -----

Column (7 & 8)... Did not specify to use impervious areas.

INCREMENTAL WEIGHTED RUNOFF: -----

Column (9): R(t) = (Ap/At) x Rip(t) + (Ai/At) x Rii(t)
R(t) = (Ap/At) x Col.(6) + (Ai/At) x Col.(8)

SCS UNIT HYDROGRAPH METHOD: -----

Column (10): Q(t) is computed with the SCS unit hydrograph method
using R() and Qu().

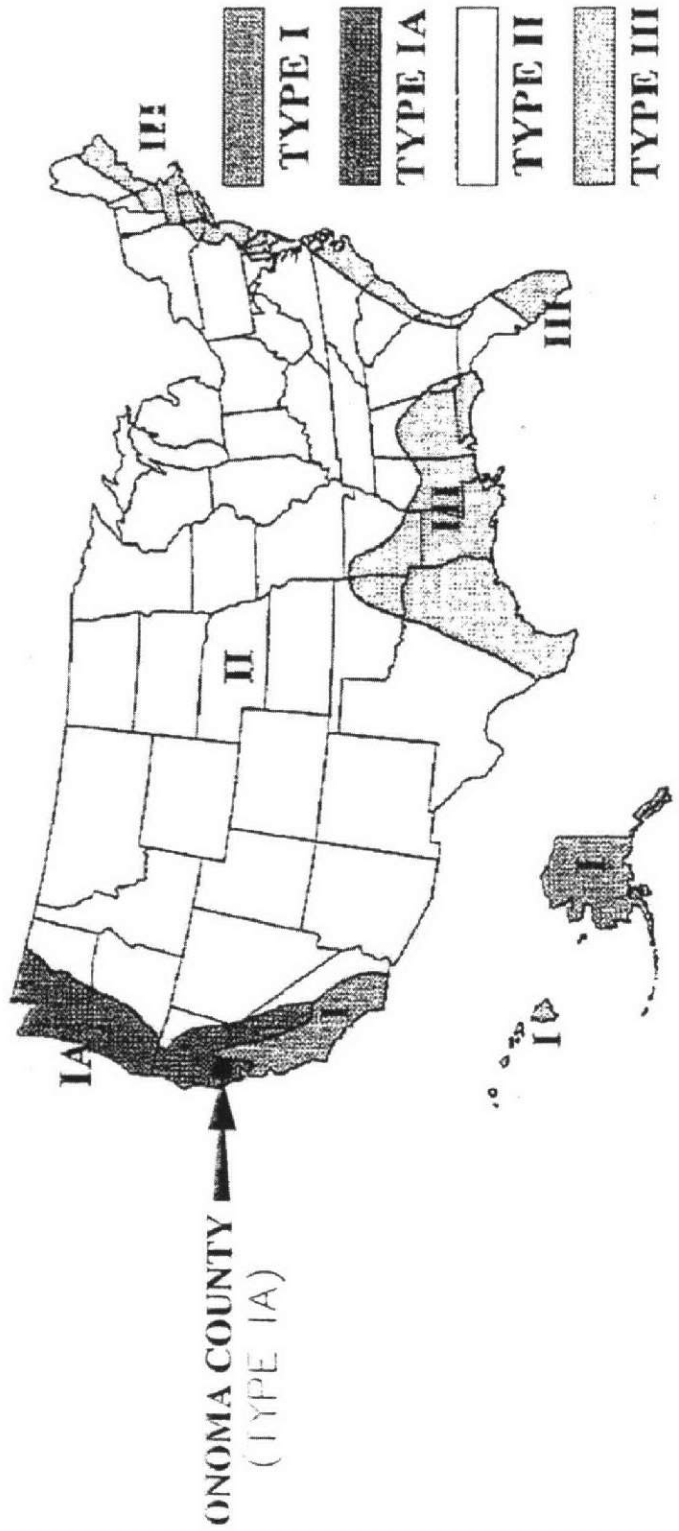

RAINFALL DISTRIBUTION BOUNDARIES

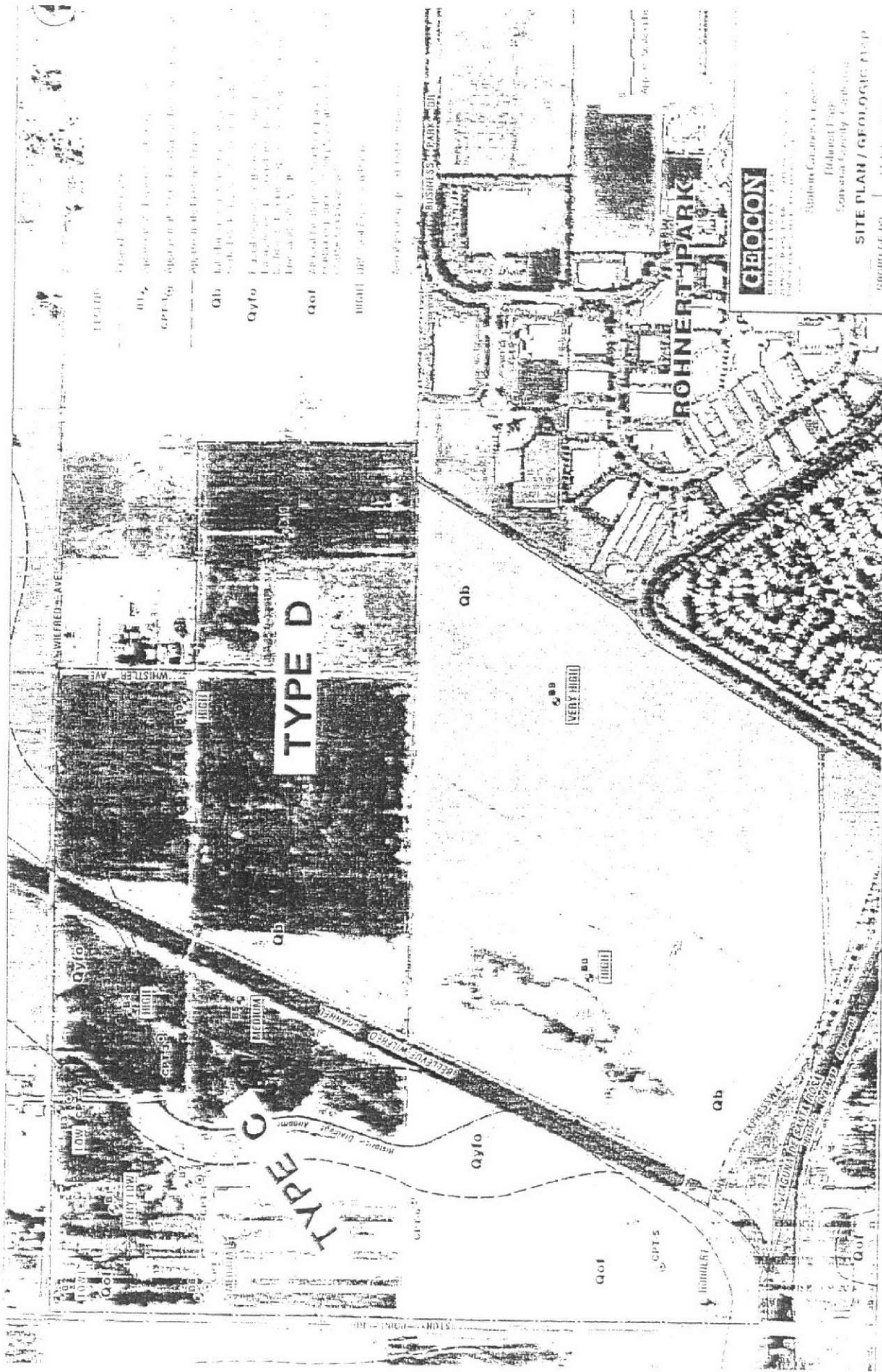

SOIL TYPES

Table 2-2c Runoff curve numbers for other agricultural lands¹

Cover type	Cover description	Hydrologic condition	Curve numbers for hydrologic soil group			
			A	B	C	D
Pasture, grassland, or range—continuous forage for grazing. ²	SITE - A	Poor	68	70	86	89
		Fair	49	60	79	84
		Good	39	61	74	80
Meadow—continuous grass, protected from grazing and generally mowed for hay.	SITE - E	—	30	58	71	78
Brush—brush-weed-grass mixture with brush the major element. ³		Poor	48	67	77	83
		Fair	35	56	70	77
		Good	30 ⁴	48	65	73
Woods—grass combination (orchard or tree farm). ⁵		Poor	37	73	82	88
		Fair	43	66	76	82
		Good	32	53	72	79
Woods. ⁶		Poor	45	66	77	83
		Fair	36	60	73	79
		Good	30 ⁴	55	70	77
Farmsteads—buildings, lanes, driveways, and surrounding lots.		—	59	74	82	86

¹ Average runoff condition, and $I_a = 0.25$.

² *Poor*: <50% ground cover or heavily grazed with no sward.

Fair: 50 to 75% ground cover and not heavily grazed.

Good: > 75% ground cover and lightly or only occasionally grazed.

³ *Poor*: <50% ground cover.

Fair: 50 to 75% ground cover.

Good: >75% ground cover.

⁴ Actual curve number is less than 30; use CN = 30 for runoff computations.

⁵ CN's shown were computed for areas with 50% woods and 50% grass (pasture) cover. Other combinations of conditions may be computed from the CN's for woods and pasture.

⁶ *Poor*: Forest litter, small trees, and brush are destroyed by heavy grazing or regular burning.

Fair: Woods are grazed but not burned, and some forest litter covers the soil.

Good: Woods are protected from grazing, and litter and brush adequately cover the soil.

**RUNOFF CURVE NUMBER
UNDEVELOPED SITE**

Table 2-2a Runoff curve numbers for urban areas¹

Cover type and hydrologic condition	Average percent impervious area ²	Curve numbers for hydrologic soil group			
		A	B	C	D
<i>Fully developed urban areas (vegetation established)</i>					
Open space (lawns, parks, golf courses, cemeteries, etc.) ³ :					
Poor condition (grass cover < 50%)		68	73	86	89
Fair condition (grass cover 50% to 75%)		49	69	79	84
Good condition (grass cover > 75%)		39	61	74	80
Impervious areas:					
Paved parking lots, roofs, driveways, etc. (excluding right-of-way)		98	98	98	98
Streets and roads:					
Paved; curbs and storm sewers (excluding right-of-way)		98	98	98	98
Paved; open ditches (including right-of-way)		93	89	92	93
Gravel (including right-of-way)		76	85	89	91
Dirt (including right-of-way)		72	82	87	89
Western desert urban areas:					
Natural desert landscaping (pervious areas only) ⁴		63	77	85	88
Artificial desert landscaping (impervious weed barrier, desert shrub with 1- to 2-inch sand or gravel mulch and basin borders)		96	96	96	96
Urban districts:					
Commercial and business	85	89	92	94	96
Industrial	72	81	88	91	93
Residential districts by average lot size:					
1/8 acre or less (town houses)	85	77	85	90	92
1/4 acre	38	61	75	83	87
1/3 acre	30	57	73	81	86
1/2 acre	25	54	70	80	85
1 acre	20	51	68	79	84
2 acres	12	46	65	77	82
<i>Developing urban areas</i>					
Newly graded areas					
(pervious areas only, no vegetation) ⁵		77	88	91	94
Idle lands (C/N _s are determined using cover types similar to those in table 2-2a)					

Average runoff condition, table 1, 4, 5, 6, 7, 8, 9, 10, 11, 12, 13, 14, 15, 16, 17, 18, 19, 20, 21, 22, 23, 24, 25, 26, 27, 28, 29, 30, 31, 32, 33, 34, 35, 36, 37, 38, 39, 40, 41, 42, 43, 44, 45, 46, 47, 48, 49, 50, 51, 52, 53, 54, 55, 56, 57, 58, 59, 60, 61, 62, 63, 64, 65, 66, 67, 68, 69, 70, 71, 72, 73, 74, 75, 76, 77, 78, 79, 80, 81, 82, 83, 84, 85, 86, 87, 88, 89, 90, 91, 92, 93, 94, 95, 96, 97, 98, 99, 100.

¹The average percent impervious area shown was used to develop the composite C/N_s. Other assumptions are as follows: impervious areas are directly connected to the drainage system; impervious areas have a C/N_s of 98; non-pervious areas are considered equivalent to open areas in and around the condition; C/N_s for other combinations of conditions may be estimated using table 2-2a or 2-2b.

²It is shown the equivalent to single or multiple C/N_s areas or conditions for other combinations of open space cover type.

³Assumes 10% of water is lost to evaporation; 10% of water is lost to infiltration; 10% of water is lost to transpiration; 10% of water is lost to surface runoff.

⁴Assumes 10% of water is lost to evaporation; 10% of water is lost to infiltration; 10% of water is lost to transpiration; 10% of water is lost to surface runoff.

⁵Assumes 10% of water is lost to evaporation; 10% of water is lost to infiltration; 10% of water is lost to transpiration; 10% of water is lost to surface runoff.

⁶Assumes 10% of water is lost to evaporation; 10% of water is lost to infiltration; 10% of water is lost to transpiration; 10% of water is lost to surface runoff.

RUNOFF CURVE NUMBER DEVELOPED SITE

ALTERNATE "SITE-I"

1. 100yr Pre-development
Hydrograph
2. 100yr Post-Development
Hydrograph
3. Detention Storage Estimate
Hydrograph

PRE-DEVELOPMENT

Type... Unit Hyd. Summary

Page 7.03

Name... SUBAREA 10 Tag: 100

Event: 100_yr

File... S:\A03068\Hydro\site-IV.ppw

Storm... TypeIA 24hr Tag: 100

SCS UNIT HYDROGRAPH METHOD

STORM EVENT: 100 year storm

Duration = 24.0000 hrs Rain Depth = 5.2320 in

Rain Dir = S:\A03068\Hydro\

Rain File -ID = - TypeIA 24hr

Unit Hyd Type = Default Curvilinear

HYG Dir = S:\A03068\Hydro\

HYG File - ID = work_pad.hyg - SUBAREA 10 100

Tc = .5000 hrs

Drainage Area = 73.000 acres Runoff CN= 79

=====
Computational Time Increment = .06667 hrs

Computed Peak Time = 8.1333 hrs

Computed Peak Flow = 45.84 cfs

Time Increment for HYG File = .0500 hrs

Peak Time, Interpolated Output = 8.1500 hrs

Peak Flow, Interpolated Output = 45.81 cfs
=====

DRAINAGE AREA

ID: SUBAREA 10

CN = 79

Area = 73.000 acres

S = 2.6582 in

0.2S = .5316 in

Cumulative Runoff

3.0024 in

18.265 ac-ft

HYG Volume... 18.265 ac-ft (area under HYG curve)

***** SCS UNIT HYDROGRAPH PARAMETERS *****

Time Concentration, Tc = .50000 hrs (ID: SUBAREA 10)

Computational Incr, Tm = .06667 hrs = 0.20000 Tp

Unit Hyd. Shape Factor = 483.432 (37.46% under rising limb)

K = 483.43/645.333, K = .7491 (also, K = 2/(1+(Tr/Tp))

Receding/Rising, Tr/Tp = 1.6698 (solved from K = .7491)

Unit peak, qp = 165.42 cfs

Unit peak time, Tp = .33333 hrs

Unit receding limb, Tr = 1.33333 hrs

Total unit time, Tb = 1.66667 hrs

Type.... Unit Hyd. (HYG output)

Name.... SUBAREA 10 Tag: 100

Event: 100 yr

File.... S:\A03068\Hydro\site-IV.ppw

Storm... TypeIA 24hr Tag: 100

SCS UNIT HYDROGRAPH METHOD

STORM EVENT: 100 year storm

Duration = 24.0000 hrs Rain Depth = 5.2320 in

Rain Dir = S:\A03068\Hydro\

Rain File -ID = - TypeIA 24hr

Unit Hyd Type = Default Curvilinear

HYG Dir = S:\A03068\Hydro\

HYG File - ID = work pad.hyg - SUBAREA 10 100

Tc = .5000 hrs

Drainage Area = 73.000 acres Runoff CN= 79

Calc.Increment= .06667 hrs Out.Incr.= .0500 hrs

HYG Volume = 18.265 ac-ft

HYDROGRAPH ORDINATES (cfs)

Output Time increment = .0500 hrs
Time on left represents time for first value in each row.

Time hrs					
3.6500	.00	.00	.01	.02	.04
3.9000	.07	.11	.16	.22	.29
4.1500	.37	.45	.53	.62	.71
4.4000	.80	.90	.99	1.09	1.20
4.6500	1.30	1.41	1.52	1.63	1.74
4.9000	1.86	1.98	2.10	2.23	2.36
5.1500	2.50	2.64	2.78	2.93	3.09
5.4000	3.24	3.40	3.56	3.71	3.87
5.6500	4.02	4.18	4.33	4.48	4.63
5.9000	4.79	4.96	5.13	5.31	5.51
6.1500	5.73	5.96	6.21	6.47	6.73
6.4000	6.99	7.25	7.50	7.73	7.94
6.6500	8.12	8.27	8.41	8.53	8.65
6.9000	8.78	8.94	9.12	9.35	9.62
7.1500	9.92	10.25	10.64	11.07	11.54
7.4000	12.05	12.63	13.33	14.25	15.46
7.6500	17.46	20.08	23.24	26.83	30.66
7.9000	34.39	37.91	41.10	43.42	45.01
8.1500	45.81	45.73	44.51	42.82	40.79
8.4000	38.53	36.20	34.03	32.04	30.24
8.6500	28.75	27.49	26.42	25.53	24.80
8.9000	24.13	23.51	22.92	22.33	21.74
9.1500	21.17	20.61	20.07	19.55	19.04
9.4000	18.56	18.09	17.66	17.25	16.88
9.6500	16.57	16.32	16.11	15.94	15.80
9.9000	15.67	15.55	15.43	15.31	15.17
10.1500	15.04	14.89	14.74	14.59	14.44
10.4000	14.30	14.16	14.04	13.93	13.83
10.6500	13.76	13.71	13.66	13.63	13.59
10.9000	13.55	13.51	13.45	13.39	13.31

HYDROGRAPH ORDINATES (cfs)

Output Time increment = .0500 hrs

Time on left represents time for first value in each row.

Time hrs					
11.1500	13.24	13.15	13.07	12.98	12.89
11.4000	12.80	12.70	12.60	12.50	12.40
11.6500	12.29	12.17	12.06	11.94	11.83
11.9000	11.72	11.63	11.54	11.46	11.40
12.1500	11.35	11.31	11.28	11.26	11.25
12.4000	11.26	11.28	11.31	11.34	11.37
12.6500	11.38	11.37	11.34	11.30	11.24
12.9000	11.18	11.12	11.06	11.03	11.00
13.1500	10.99	11.00	11.02	11.04	11.05
13.4000	11.06	11.05	11.02	10.99	10.94
13.6500	10.90	10.85	10.79	10.74	10.70
13.9000	10.65	10.61	10.57	10.54	10.52
14.1500	10.50	10.48	10.47	10.47	10.46
14.4000	10.46	10.45	10.45	10.44	10.42
14.6500	10.41	10.40	10.38	10.37	10.35
14.9000	10.34	10.32	10.30	10.29	10.27
15.1500	10.25	10.24	10.22	10.21	10.19
15.4000	10.17	10.16	10.14	10.12	10.10
15.6500	10.08	10.06	10.04	10.03	10.01
15.9000	9.99	9.98	9.96	9.94	9.92
16.1500	9.90	9.89	9.87	9.85	9.83
16.4000	9.81	9.79	9.77	9.75	9.73
16.6500	9.72	9.70	9.68	9.66	9.64
16.9000	9.62	9.60	9.58	9.56	9.54
17.1500	9.53	9.51	9.49	9.47	9.45
17.4000	9.42	9.40	9.38	9.36	9.34
17.6500	9.32	9.31	9.29	9.27	9.25
17.9000	9.23	9.21	9.19	9.16	9.14
18.1500	9.12	9.10	9.08	9.06	9.04
18.4000	9.02	9.00	8.98	8.96	8.94
18.6500	8.92	8.90	8.87	8.85	8.83
18.9000	8.81	8.79	8.77	8.75	8.72
19.1500	8.70	8.68	8.66	8.64	8.62
19.4000	8.60	8.58	8.55	8.53	8.51
19.6500	8.49	8.47	8.45	8.42	8.40
19.9000	8.38	8.36	8.33	8.31	8.29
20.1500	8.27	8.25	8.23	8.21	8.18
20.4000	8.16	8.14	8.12	8.09	8.07
20.6500	8.04	8.02	8.00	7.98	7.96
20.9000	7.93	7.91	7.89	7.87	7.85
21.1500	7.82	7.80	7.78	7.75	7.73
21.4000	7.71	7.68	7.66	7.64	7.61
21.6500	7.59	7.57	7.55	7.52	7.50
21.9000	7.48	7.46	7.43	7.41	7.39
22.1500	7.36	7.34	7.32	7.29	7.27

Type.... Unit Hyd. (HYG output)
 Name.... SUBAREA 10 Tag: 100
 File.... S:\A03068\Hydro\site-IV.ppw
 Storm... TypeIA 24hr Tag: 100

Page 7.06
 Event: 100 yr

HYDROGRAPH ORDINATES (cfs)

Output Time increment = .0500 hrs

Time on left represents time for first value in each row.

Time hrs					
22.4000	7.24	7.22	7.20	7.17	7.15
22.6500	7.13	7.10	7.08	7.06	7.04
22.9000	7.01	6.99	6.97	6.94	6.92
23.1500	6.89	6.87	6.84	6.82	6.80
23.4000	6.77	6.75	6.73	6.70	6.68
23.6500	6.66	6.63	6.61	6.58	6.56
23.9000	6.53	6.51	6.49	6.39	6.20
24.1500	5.87	5.39	4.71	4.00	3.30
24.4000	2.63	2.07	1.61	1.25	.97
24.6500	.77	.60	.47	.36	.28
24.9000	.22	.17	.13	.10	.08
25.1500	.06	.04	.03	.02	.02
25.4000	.01	.01	.00	.00	.00

POST-DEVELOPMENT

Type.... Unit Hyd. Summary

Page 7.03

Name.... SUBAREA 10 Tag: 100

Event: 100 yr

File.... S:\A03068\Hydro\Site IV-Post.ppw

Storm... TypeIA 24hr Tag: 100

SCS UNIT HYDROGRAPH METHOD

STORM EVENT: 100 year storm

Duration = 24.0000 hrs Rain Depth = 5.2320 in

Rain Dir = S:\A03068\Hydro\

Rain File -ID = - TypeIA 24hr

Unit Hyd Type = Default Curvilinear

HYG Dir = S:\A03068\Hydro\

HYG File - ID = work pad.hyg - SUBAREA 10 100

Tc = .5000 hrs

Drainage Area = 73.000 acres Runoff CN= 94

=====
Computational Time Increment = .06667 hrs

Computed Peak Time = 8.1333 hrs

Computed Peak Flow = 74.65 cfs

Time Increment for HYG File = .0500 hrs

Peak Time, Interpolated Output = 8.1500 hrs

Peak Flow, Interpolated Output = 74.30 cfs
=====

DRAINAGE AREA

ID: SUBAREA 10

CN = 94

Area = 73.000 acres

S = .6383 in

0.2S = .1277 in

Cumulative Runoff

4.5370 in

27.600 ac-ft

HYG Volume... 27.600 ac-ft (area under HYG curve)

***** SCS UNIT HYDROGRAPH PARAMETERS *****

Time Concentration, Tc = .50000 hrs (ID: SUBAREA 10)

Computational Incr, Tm = .06667 hrs = 0.20000 Tp

Unit Hyd. Shape Factor = 483.432 (37.46% under rising limb)

K = 483.43/645.333, K = .7491 (also, $K = 2/(1+(Tr/Tp))$)

Receding/Rising, Tr/Tp = 1.6698 (solved from $K = .7491$)

Unit peak, qp = 165.42 cfs

Unit peak time, Tp = .33333 hrs

Unit receding limb, Tr = 1.33333 hrs

Total unit time, Tb = 1.66667 hrs

Type.... Unit Hyd. (HYG output)

Page 7.04

Name.... SUBAREA 10 Tag: 100

Event: 100 yr

File.... S:\A03068\Hydro\Site IV-Post.ppw

Storm... TypeIA 24hr Tag: 100

SCS UNIT HYDROGRAPH METHOD

STORM EVENT: 100 year storm

Duration = 24.0000 hrs Rain Depth = 5.2320 in

Rain Dir = S:\A03068\Hydro\

Rain File -ID = - TypeIA 24hr

Unit Hyd Type = Default Curvilinear

HYG Dir = S:\A03068\Hydro\

HYG File - ID = work pad.hyg - SUBAREA 10 100

Tc = .5000 hrs

Drainage Area = 73.000 acres Runoff CN= 94

Calc.Increment= .06667 hrs Out.Incr.= .0500 hrs

HYG Volume = 27.600 ac-ft

HYDROGRAPH ORDINATES (cfs)

Output Time increment = .0500 hrs
Time on left represents time for first value in each row.

Time hrs	0.00	0.05	0.10	0.15	0.20
1.1500	.00	.00	.01	.02	.06
1.4000	.11	.20	.31	.45	.62
1.6500	.80	1.00	1.19	1.39	1.59
1.9000	1.79	1.99	2.19	2.38	2.58
2.1500	2.78	2.98	3.19	3.39	3.59
2.4000	3.79	3.98	4.17	4.35	4.53
2.6500	4.70	4.86	5.02	5.16	5.31
2.9000	5.44	5.57	5.70	5.83	5.94
3.1500	6.06	6.16	6.26	6.36	6.46
3.4000	6.56	6.67	6.78	6.90	7.03
3.6500	7.18	7.33	7.50	7.68	7.86
3.9000	8.04	8.22	8.40	8.57	8.74
4.1500	8.89	9.04	9.17	9.31	9.44
4.4000	9.57	9.70	9.84	9.99	10.14
4.6500	10.29	10.45	10.62	10.79	10.96
4.9000	11.14	11.33	11.52	11.73	11.94
5.1500	12.16	12.39	12.64	12.89	13.13
5.4000	13.38	13.63	13.87	14.10	14.32
5.6500	14.52	14.71	14.89	15.06	15.24
5.9000	15.43	15.63	15.85	16.10	16.38
6.1500	16.70	17.05	17.45	17.85	18.25
6.4000	18.65	19.02	19.35	19.64	19.88
6.6500	20.03	20.12	20.17	20.18	20.20
6.9000	20.25	20.35	20.51	20.76	21.09
7.1500	21.48	21.93	22.50	23.12	23.82
7.4000	24.58	25.46	26.54	27.98	29.94
7.6500	33.25	37.56	42.70	48.49	54.45
7.9000	60.06	65.16	69.55	72.37	73.98
8.1500	74.30	73.27	70.56	67.21	63.41
8.4000	59.34	55.30	51.57	48.16	45.11

Type.... Unit Hyd. (HYG output)
 Name.... SUBAREA 10 Tag: 100
 File.... S:\A03068\Hydro\Site IV-Post.ppw
 Storm... TypeIA 24hr Tag: 100

Page 7.05
 Event: 100 yr

HYDROGRAPH ORDINATES (cfs)

Output Time increment = .0500 hrs

Time on left represents time for first value in each row.

Time hrs					
8.6500	42.60	40.44	38.61	37.07	35.80
8.9000	34.65	33.59	32.57	31.59	30.63
9.1500	29.70	28.80	27.95	27.13	26.34
9.4000	25.59	24.88	24.21	23.59	23.02
9.6500	22.55	22.15	21.81	21.52	21.29
9.9000	21.08	20.87	20.67	20.46	20.25
10.1500	20.02	19.80	19.56	19.33	19.10
10.4000	18.88	18.67	18.48	18.31	18.15
10.6500	18.03	17.93	17.84	17.77	17.70
10.9000	17.62	17.54	17.45	17.34	17.22
11.1500	17.10	16.97	16.84	16.70	16.57
11.4000	16.43	16.28	16.14	15.99	15.84
11.6500	15.69	15.52	15.36	15.19	15.03
11.9000	14.88	14.75	14.62	14.52	14.42
12.1500	14.34	14.27	14.22	14.19	14.17
12.4000	14.16	14.18	14.20	14.22	14.25
12.6500	14.25	14.23	14.18	14.11	14.03
12.9000	13.94	13.85	13.77	13.71	13.67
13.1500	13.65	13.65	13.66	13.68	13.68
13.4000	13.68	13.65	13.61	13.56	13.50
13.6500	13.43	13.36	13.28	13.21	13.15
13.9000	13.08	13.02	12.97	12.92	12.88
14.1500	12.85	12.82	12.80	12.79	12.77
14.4000	12.76	12.74	12.73	12.71	12.68
14.6500	12.66	12.64	12.61	12.59	12.56
14.9000	12.53	12.50	12.47	12.45	12.42
15.1500	12.39	12.37	12.34	12.32	12.29
15.4000	12.26	12.23	12.21	12.18	12.15
15.6500	12.12	12.09	12.06	12.03	12.01
15.9000	11.98	11.95	11.93	11.90	11.87
16.1500	11.84	11.81	11.79	11.76	11.73
16.4000	11.70	11.67	11.64	11.62	11.59
16.6500	11.56	11.53	11.50	11.48	11.45
16.9000	11.42	11.39	11.37	11.34	11.31
17.1500	11.28	11.26	11.23	11.20	11.17
17.4000	11.14	11.11	11.08	11.05	11.03
17.6500	11.00	10.97	10.94	10.92	10.89
17.9000	10.86	10.83	10.80	10.77	10.74
18.1500	10.72	10.69	10.66	10.63	10.60
18.4000	10.58	10.55	10.52	10.49	10.47
18.6500	10.44	10.41	10.38	10.35	10.32
18.9000	10.29	10.26	10.23	10.21	10.18
19.1500	10.15	10.12	10.09	10.07	10.04
19.4000	10.01	9.98	9.95	9.93	9.90
19.6500	9.87	9.84	9.81	9.78	9.75

Type.... Unit Hyd. (HYG output)

Page 7.06

Name.... SUBAREA 10 Tag: 100

Event: 100 yr

File.... S:\A03068\Hydro\Site IV-Post.ppw

Storm... TypeIA 24hr Tag: 100

HYDROGRAPH ORDINATES (cfs)

Output Time increment = .0500 hrs

Time on left represents time for first value in each row.

Time hrs					
19.9000	9.72	9.69	9.66	9.64	9.61
20.1500	9.58	9.55	9.53	9.50	9.47
20.4000	9.44	9.41	9.39	9.36	9.33
20.6500	9.30	9.27	9.24	9.21	9.18
20.9000	9.15	9.13	9.10	9.07	9.04
21.1500	9.01	8.98	8.96	8.93	8.90
21.4000	8.87	8.84	8.81	8.78	8.75
21.6500	8.73	8.70	8.67	8.64	8.61
21.9000	8.58	8.56	8.53	8.50	8.47
22.1500	8.44	8.41	8.39	8.36	8.33
22.4000	8.30	8.27	8.24	8.21	8.18
22.6500	8.15	8.13	8.10	8.07	8.04
22.9000	8.01	7.99	7.96	7.93	7.90
23.1500	7.87	7.84	7.81	7.78	7.75
23.4000	7.72	7.70	7.67	7.64	7.61
23.6500	7.58	7.55	7.52	7.49	7.46
23.9000	7.44	7.41	7.38	7.27	7.05
24.1500	6.68	6.12	5.35	4.55	3.75
24.4000	2.99	2.35	1.83	1.42	1.10
24.6500	.87	.68	.53	.41	.32
24.9000	.25	.19	.15	.12	.09
25.1500	.07	.05	.04	.03	.02
25.4000	.01	.01	.00	.00	.00

SITE-IV-PRE-100

Hydrograph
OUT 10 100

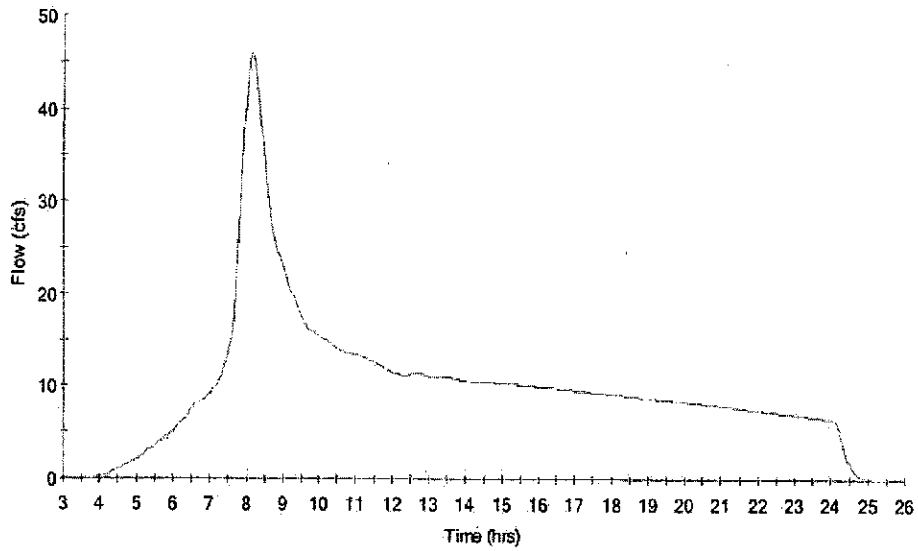

SITE-IV-POST-100

Hydrograph
OUT 10 100

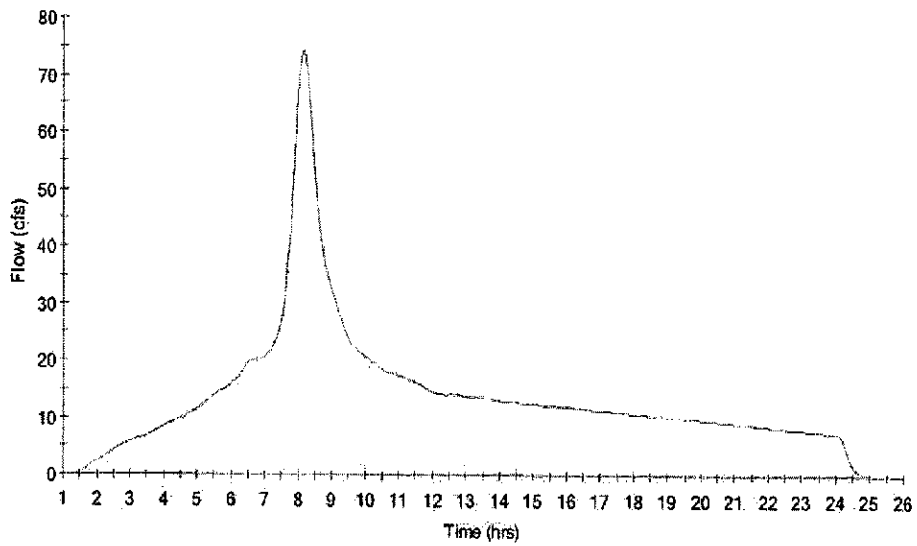

STORAGE ESTIMATE

Return Event	Pre Dev Peak (cfs)	Pre Dev Volume (ac-ft)	Post Dev Peak (cfs)	Post Total Volume (ac-ft)	Estimated Storage (ac-ft)	Interp. W.S. Elev. (ft)	Freeboard Depth (ft)
100	24.7324	0.00000	39.7485	14.45400	9.44620	91.2860	PASS

ALTERNATE "SITE-II"

1. 100yr Pre-development
Hydrograph
2. 100yr Post-Development
Hydrograph
3. Detention Storage Estimate
Hydrograph

PRE-DEVELOPMENT

Type.... SCS Unit Hyd. Summary
Name.... SITE-A 100-PRE Tag: 100
File.... S:\A03068\HYDRO\NW-100YR.PPK

Page 3.03
Event: 100 yr

SCS UNIT HYDROGRAPH METHOD

STORM EVENT: 100 year storm
Duration = 24.0000 hrs Rain Depth = 5.3320 in
Rain Dir = S:\HAESTAD\PPK6\
Rain File -ID = 100-YR.RNF - Depth Tbl 100YR
Unit Hyd Type = Default Curvilinear
HYG Dir = S:\A03068\HYDRO\
HYG File - ID = NW-100YR.HYG - SITE-A 100-PRE 100
Tc = .5000 hrs
Drainage Area = 79.200 acres Runoff CN= 79

=====
Computational Time Increment = .06667 hrs
Computed Peak Time = 12.4000 hrs
Computed Peak Flow = 90.77 cfs

Time Increment for HYG File = .0500 hrs
Peak Time, Interpolated Output = 12.4000 hrs
Peak Flow, Interpolated Output = 90.77 cfs
=====

DRAINAGE AREA

ID:None Selected
CN = 79
Area = 79.200 acres
S = 2.6582 in
0.2S = .5316 in

Cumulative Runoff

3.0024 in
19.816 ac-ft

HYG Volume... 19.815 ac-ft (area under HYG curve)

***** UNIT HYDROGRAPH PARAMETERS *****

Time Concentration, Tc = .50000 hrs (ID: None Selected)
Computational Incr, Tm = .06667 hrs = 0.20000 Tp

Unit Hyd. Shape Factor = 483.432 (37.46% under rising limb)
K = 483.43/645.333, K = .7491 (also, K = 2/(1+(Tr/Tp))
Receding/Rising, Tr/Tp = 1.6698 (solved from K = .7491)

Unit peak, qp = 179.47 cfs
Unit peak time Tp = 1.33333 hrs
Unit receding limb, Tr = 1.33333 hrs
Total unit time, Tb = 1.66667 hrs

S/N: HOMOLO102006 Robert A. Karn & Associates, Inc.
Pond Pack Ver: 8-01-98 (52) Compute Time: 14:49:54

Date: 01-19-2004

Type.... SCS Unit Hyd. (HYG output)
 Name.... SITE-A 100-PRE Tag: 100
 File.... S:\A03068\HYDRO\NW-100YR.PPK

Page 3.04
 Event: 100 yr

SCS UNIT HYDROGRAPH METHOD

STORM EVENT: 100 year storm
 Duration = 24.0000 hrs Rain Depth = 5.2320 in
 Rain Dir = S:\HAESTAD\PPK6\
 Rain File -ID = 100-YR.RNF - Depth Tbl 100YR
 Unit Hyd Type = Default Curvilinear
 HYG Dir = S:\A03068\HYDRO\
 HYG File - ID = NW-100YR.HYG - SITE-A 100-PRE 100
 Tc = .5000 hrs
 Drainage Area = 79.200 acres Runoff CN= 79
 Calc.Increment= .06667 hrs Out.Incr.= .0500 hrs
 HYG Volume = 19.815 ac-ft

HYDROGRAPH ORDINATES (cfs)

Output Time increment = .0500 hrs
 Time on left represents time for first value in each row.

Time hrs					
5.3000	.00	.00	.00	.01	.03
5.5500	.05	.08	.13	.18	.24
5.8000	.31	.39	.47	.55	.64
6.0500	.74	.83	.93	1.04	1.14
6.3000	1.25	1.36	1.47	1.59	1.71
6.5500	1.83	1.95	2.08	2.20	2.33
6.8000	2.46	2.60	2.73	2.87	3.01
7.0500	3.12	3.18	3.19	3.13	2.97
7.3000	2.80	2.63	2.46	2.34	2.27
7.5500	2.23	2.23	2.27	2.32	2.39
7.8000	2.48	2.58	2.69	2.81	2.94
8.0500	3.07	3.22	3.36	3.52	3.68
8.3000	3.84	4.01	4.19	4.37	4.56
8.5500	4.75	4.95	5.15	5.36	5.57
8.8000	5.79	6.01	6.24	6.47	6.71
9.0500	6.85	6.85	6.66	6.23	5.52
9.3000	4.73	3.93	3.15	2.51	2.03
9.5500	1.59	1.49	1.45	1.51	1.65
9.8000	1.88	2.21	2.59	3.02	3.49
10.0500	4.00	4.54	5.10	5.69	6.32
10.3000	6.96	7.61	8.29	8.99	9.71
10.5500	10.46	11.23	12.03	12.84	13.68
10.8000	14.53	15.42	16.34	17.28	18.23
11.0500	18.99	19.44	19.50	19.07	18.16
11.3000	17.28	16.58	16.20	16.48	17.23
11.5500	18.30	19.54	20.39	21.03	21.65
11.8000	22.43	24.26	26.84	30.05	33.77
12.0500	38.96	45.63	53.93	64.02	74.64
12.3000	83.12	88.74	90.77	88.21	83.48
12.5500	77.32	70.45	64.59	59.86	56.03
12.8000	52.89	50.06	47.19	44.24	41.16
13.0500	38.13	35.49	33.47	32.26	32.10

Type.... SCS Unit Hyd. (HYG output)
 Name.... SITE-A 100-PRE Tag: 100
 File.... S:\A03068\HYDRO\NW-100YR.PPK

Page 3.05
 Event: 100 yr

HYDROGRAPH ORDINATES (cfs)

Output Time increment = .0500 hrs

Time on left represents time for first value in each row.

Time hrs					
13.3000	32.33	32.79	33.35	33.76	33.89
13.5500	33.74	33.36	32.77	32.09	31.33
13.8000	30.51	29.61	28.66	27.67	26.65
14.0500	25.58	24.50	23.41	22.29	21.14
14.3000	20.00	18.85	17.69	16.53	15.36
14.5500	14.17	12.97	11.78	10.58	9.39
14.8000	8.20	7.03	5.91	4.85	3.89
15.0500	3.17	2.66	2.40	2.46	3.02
15.3000	3.92	5.12	6.61	8.24	9.77
15.5500	11.15	12.34	13.19	13.82	14.25
15.8000	14.52	14.62	14.64	14.59	14.48
16.0500	14.31	14.12	13.89	13.65	13.37
16.3000	13.09	12.80	12.50	12.19	11.87
16.5500	11.55	11.21	10.88	10.54	10.21
16.8000	9.87	9.52	9.18	8.84	8.49
17.0500	8.27	8.21	8.38	8.83	9.61
17.3000	10.47	11.34	12.18	12.88	13.42
17.5500	13.82	14.09	14.26	14.37	14.44
17.8000	14.47	14.45	14.41	14.36	14.28
18.0500	14.19	14.10	13.99	13.88	13.76
18.3000	13.64	13.52	13.39	13.26	13.14
18.5500	13.01	12.87	12.74	12.61	12.47
18.8000	12.34	12.20	12.06	11.92	11.79
19.0500	11.65	11.52	11.38	11.24	11.11
19.3000	10.97	10.83	10.70	10.56	10.42
19.5500	10.28	10.14	10.00	9.86	9.73
19.8000	9.59	9.45	9.31	9.17	9.03
20.0500	8.89	8.75	8.61	8.46	8.32
20.3000	8.18	8.04	7.90	7.75	7.61
20.5500	7.47	7.33	7.19	7.05	6.91
20.8000	6.76	6.62	6.48	6.33	6.19
21.0500	6.05	5.91	5.77	5.62	5.48
21.3000	5.34	5.20	5.06	4.91	4.77
21.5500	4.63	4.48	4.33	4.19	4.05
21.8000	3.91	3.77	3.62	3.48	3.33
22.0500	3.26	3.31	3.50	3.87	4.45
22.3000	5.08	5.72	6.32	6.82	7.21
22.5500	7.51	7.72	7.85	7.95	8.01
22.8000	8.05	8.05	8.04	8.01	7.98
23.0500	7.94	7.89	7.83	7.78	7.71
23.3000	7.65	7.58	7.51	7.45	7.38
23.5500	7.31	7.23	7.16	7.08	7.00
23.8000	6.93	6.85	6.78	6.70	6.63
24.0500	6.49	6.26	5.90	5.39	4.70
24.3000	3.99	3.28	2.61	2.05	1.60
24.5500	1.24	.96	.76	.60	.46
24.8000	.36	.28	.22	.17	.13

Type.... SCS Unit Hyd. (HYG output)
Name.... SITE-A 100-PRE Tag: 100
File.... S:\A03068\HYDRO\NW-100YR.PPK

HYDROGRAPH ORDINATES (cfs)
Output Time increment = .0500 hrs
Time on left represents time for first value in each row.

Time hrs					
25.0500	.10	.08	.06	.04	.03
25.3000	.02	.02	.01	.01	.00
25.5500	.00	.00			

POST-DEVELOPMENT

Type... SCS Unit Hyd. Summary
Name... SITE-A 100-POST Tag: 100
File... S:\A03068\HYDRO\NW-100YR.PPK

Page 3.03
Event: 100 yr

SCS UNIT HYDROGRAPH METHOD

STORM EVENT: 100 year storm
Duration = 24.0000 hrs Rain Depth = 5.2320 in
Rain Dir = S:\HAESTAD\PPK6\
Rain File -ID = 100-YR.RNF - Depth Tbl 100YR
Unit Hyd Type = Default Curvilinear
HYG Dir = S:\A03068\HYDRO\
HYG File - ID = NW-100YR.HYG - SITE-A 100-POST 100
Tc = .5000 hrs
Drainage Area = 79.200 acres Runoff CN= 94

=====
Computational Time Increment = .06667 hrs
Computed Peak Time = 12.4000 hrs
Computed Peak Flow = 128.09 cfs

Time Increment for HYG File = .0500 hrs
Peak Time, Interpolated Output = 12.4000 hrs
Peak Flow, Interpolated Output = 128.09 cfs
=====

DRAINAGE AREA

ID:None Selected
CN = 94
Area = 79.200 acres
S = .6383 in
0.2S = .1277 in

Cumulative Runoff

4.5370 in
29.944 ac-ft

HYG Volume... 29.944 ac-ft (area under HYG curve)

***** UNIT HYDROGRAPH PARAMETERS *****

Time Concentration, Tc = .50000 hrs (ID: None Selected)
Computational Incr, Tm = .06667 hrs = 0.20000 Tp

Unit Hyd. Shape Factor = 483.432 (37.46% under rising limb)
K = 483.43/645.333, K = .7491 (also, K = 2/(1+(Tr/Tp))
Receding/Rising, Tr/Tp = 1.6698 (solved from K = .7491)

Unit peak, qp = 179.47 cfs
Unit peak time, Tp = .33333 hrs
Unit receding limb, Tr = 1.33333 hrs
Total unit time, Tb = 1.66667 hrs

Type.... SCS Unit Hyd. (HYG output)
 Name.... SITE-A 100-POST Tag: 100
 File.... S:\A03068\HYDRO\NW-100YR.PPK

Page 3.04
 Event: 100 yr

SCS UNIT HYDROGRAPH METHOD

STORM EVENT: 100 year storm
 Duration = 24.0000 hrs Rain Depth = 5.2320 in
 Rain Dir = S:\HAESTAD\PPK6\
 Rain File -ID = 100-YR.RNF - Depth Tbl 100YR
 Unit Hyd Type = Default Curvilinear
 HYG Dir = S:\A03068\HYDRO\
 HYG File - ID = NW-100YR.HYG - SITE-A 100-POST 100
 Tc = .5000 hrs
 Drainage Area = 79.200 acres Runoff CN= 94
 Calc.Increment= .06667 hrs Out.Incr.= .0500 hrs
 HYG Volume = 29.944 ac-ft

HYDROGRAPH ORDINATES (cfs)

Output Time increment = .0500 hrs

Time on left represents time for first value in each row.

Time hrs	Output Time increment = .0500 hrs				
	Time on left represents time for first value in each row.				
1.3000	.00	.00	.01	.02	.05
1.5500	.08	.14	.21	.31	.41
1.8000	.53	.66	.80	.94	1.08
2.0500	1.21	1.31	1.37	1.38	1.32
2.3000	1.25	1.16	1.07	1.00	.95
2.5500	.92	.92	.93	.95	.98
2.8000	1.02	1.06	1.11	1.17	1.23
3.0500	1.29	1.36	1.43	1.50	1.58
3.3000	1.66	1.75	1.83	1.92	2.01
3.5500	2.11	2.20	2.30	2.41	2.51
3.8000	2.62	2.73	2.84	2.96	3.08
4.0500	3.20	3.33	3.45	3.58	3.72
4.3000	3.85	3.98	4.12	4.26	4.40
4.5500	4.54	4.69	4.84	4.99	5.15
4.8000	5.30	5.46	5.62	5.79	5.95
5.0500	6.11	6.28	6.45	6.62	6.79
5.3000	6.96	7.14	7.31	7.49	7.67
5.5500	7.85	8.03	8.21	8.40	8.58
5.8000	8.76	8.95	9.13	9.32	9.51
6.0500	9.70	9.90	10.09	10.28	10.48
6.3000	10.67	10.87	11.06	11.25	11.44
6.5500	11.64	11.84	12.03	12.23	12.43
6.8000	12.63	12.83	13.03	13.23	13.43
7.0500	13.52	13.46	13.19	12.66	11.84
7.3000	10.98	10.13	9.35	8.75	8.33
7.5500	8.07	7.94	7.95	8.02	8.14
7.8000	8.32	8.54	8.80	9.07	9.37
8.0500	9.68	10.00	10.33	10.67	11.03
8.3000	11.39	11.75	12.11	12.48	12.86
8.5500	13.24	13.62	14.01	14.40	14.79
8.8000	15.18	15.57	15.97	16.37	16.76
9.0500	16.93	16.78	16.19	15.05	13.27

Type.... SCS Unit Hyd. (HYG output)
 Name.... SITE-A 100-POST Tag: 100
 File.... S:\A03068\HYDRO\NW-100YR.EPK

Page 3.05
 Event: 100 yr

HYDROGRAPH ORDINATES (cfs)

Output Time increment = .0500 hrs

Time on left represents time for first value in each row.

Time hrs					
9.3000	11.35	9.40	7.53	6.00	4.83
9.5500	4.01	3.52	3.40	3.51	3.82
9.8000	4.31	5.03	5.87	6.81	7.82
10.0500	8.92	10.06	11.23	12.45	13.72
10.3000	14.99	16.28	17.58	18.90	20.24
10.5500	21.59	22.96	24.34	25.72	27.12
10.8000	28.51	29.93	31.36	32.79	34.22
11.0500	35.27	35.77	35.57	34.52	32.65
11.3000	30.85	29.36	28.45	28.65	29.65
11.5500	31.19	33.01	34.20	35.01	35.76
11.8000	36.74	39.30	43.00	47.62	52.96
12.0500	60.28	69.54	80.93	94.60	108.67
12.3000	119.55	126.33	128.09	123.54	116.09
12.5500	106.76	96.59	87.96	80.96	75.27
12.8000	70.57	66.40	62.26	58.08	53.79
13.0500	49.64	46.03	43.23	41.48	41.11
13.3000	41.23	41.66	42.23	42.62	42.66
13.5500	42.37	41.78	40.94	40.00	38.98
13.8000	37.88	36.69	35.45	34.16	32.85
14.0500	31.49	30.12	28.73	27.32	25.89
14.3000	24.46	23.03	21.59	20.15	18.71
14.5500	17.25	15.78	14.32	12.85	11.40
14.8000	9.95	8.53	7.16	5.88	4.71
15.0500	3.84	3.22	2.91	2.98	3.65
15.3000	4.73	6.19	7.97	9.94	11.78
15.5500	13.44	14.87	15.89	16.63	17.14
15.8000	17.45	17.56	17.57	17.50	17.36
16.0500	17.15	16.90	16.62	16.32	15.99
16.3000	15.64	15.28	14.91	14.54	14.15
16.5500	13.75	13.35	12.95	12.54	12.13
16.8000	11.73	11.31	10.90	10.49	10.08
17.0500	9.81	9.74	9.93	10.46	11.38
17.3000	12.38	13.41	14.40	15.21	15.84
17.5500	16.31	16.62	16.81	16.94	17.01
17.8000	17.03	17.00	16.95	16.87	16.77
18.0500	16.66	16.54	16.41	16.27	16.12
18.3000	15.97	15.82	15.66	15.51	15.35
18.5500	15.19	15.03	14.86	14.70	14.54
18.8000	14.37	14.21	14.04	13.87	13.71
19.0500	13.55	13.38	13.22	13.06	12.89
19.3000	12.73	12.57	12.40	12.24	12.08
19.5500	11.91	11.74	11.58	11.41	11.25
19.8000	11.09	10.92	10.76	10.59	10.43
20.0500	10.26	10.10	9.93	9.77	9.60
20.3000	9.43	9.27	9.10	8.93	8.77
20.5500	8.50	8.44	8.27	8.11	7.95
20.8000	7.78	7.62	7.45	7.28	7.12

Type.... SCS Unit Hyd. (HYG output)
Name.... SITE-A 100-POST Tag: 100
File.... S:\A03068\HYDRO\NW-100YR.PPK

Page 3.06
Event: 100 yr

HYDROGRAPH ORDINATES (cfs)
Output Time increment = .0500 hrs
Time on left represents time for first value in each row.

Time hrs						
21.0500	6.95	6.79	6.62	6.46	6.29	
21.3000	6.13	5.97	5.80	5.64	5.47	
21.5500	5.31	5.14	4.97	4.81	4.64	
21.8000	4.48	4.32	4.15	3.98	3.82	
22.0500	3.74	3.79	4.01	4.43	5.10	
22.3000	5.82	6.55	7.24	7.81	8.25	
22.5500	8.59	8.83	8.98	9.09	9.16	
22.8000	9.20	9.20	9.19	9.15	9.11	
23.0500	9.06	9.00	8.94	8.87	8.80	
23.3000	8.72	8.65	8.57	8.49	8.41	
23.5500	8.32	8.24	8.15	8.06	7.97	
23.8000	7.89	7.80	7.71	7.63	7.54	
24.0500	7.38	7.11	6.71	6.12	5.34	
24.3000	4.53	3.73	2.97	2.33	1.82	
24.5500	1.41	1.09	.86	.68	.52	
24.8000	.41	.32	.25	.19	.15	
25.0500	.11	.09	.07	.05	.04	
25.3000	.03	.02	.01	.01	.00	
25.5500	.00	.00				

SITE-1

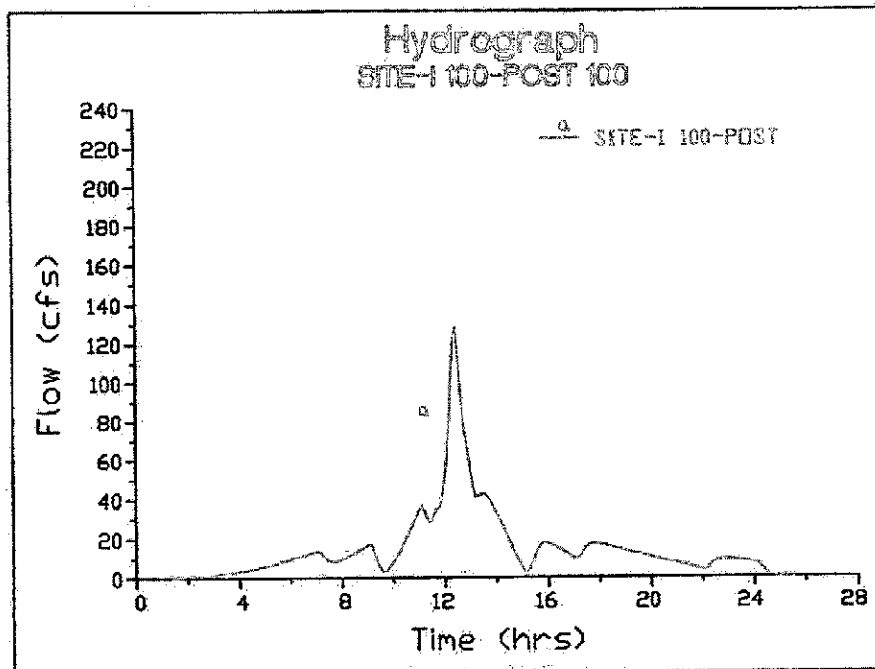
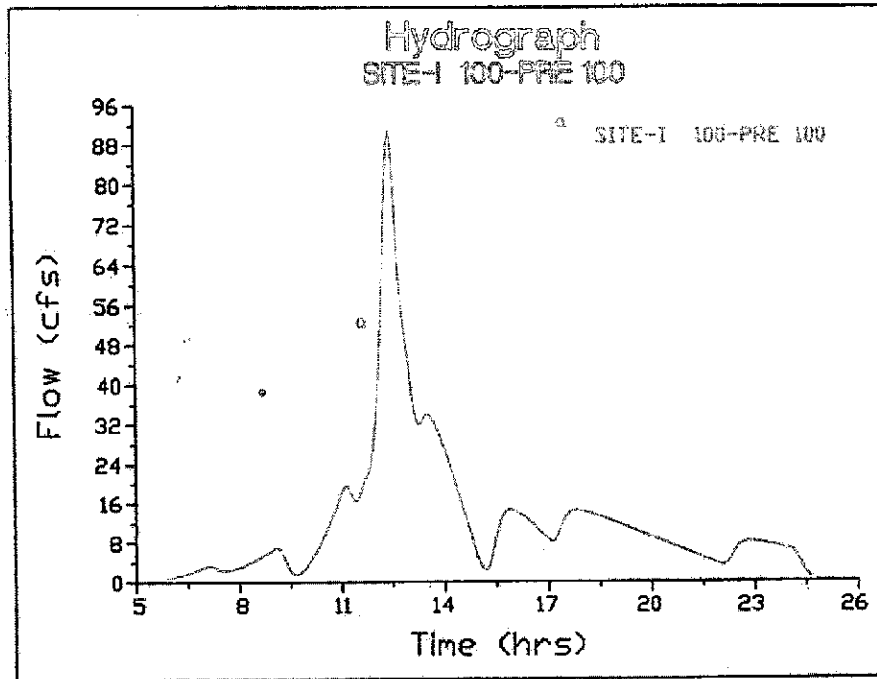

HYDRO/PRE&POST-SITEA

STORAGE ESTIMATE

Type... Vol.Est: Overlay Est.
 Name... VOL SITE-A

Page 3.01

File... S:\A03068\HYDRO\NW-100YR.PPK
 Title... PRE DEVELOPED vs DEVELOPED

DETENTION STORAGE ESTIMATE (Estimated by overlaying hydrographs)

INFLOW HYDROGRAPH...
 HYG file = NW-100YR.HYG
 HYG ID = SITE-A 100-POST
 HYG Tag = 100

OVERLAY HYDROGRAPH...
 HYG file = NW-100YR.HYG
 HYG ID = SITE-A 100-PRE
 HYG Tag = 100

Estimate Type	Est.Storage ac-ft	From hrs	To hrs
Overlay HYG	10.128	1.3000	25.6000

WARNING: Hydrographs did not cross on
 receding limb of inflow hydrograph.

Hydrograph

SITE-1 100-PRE Vs 100-POST

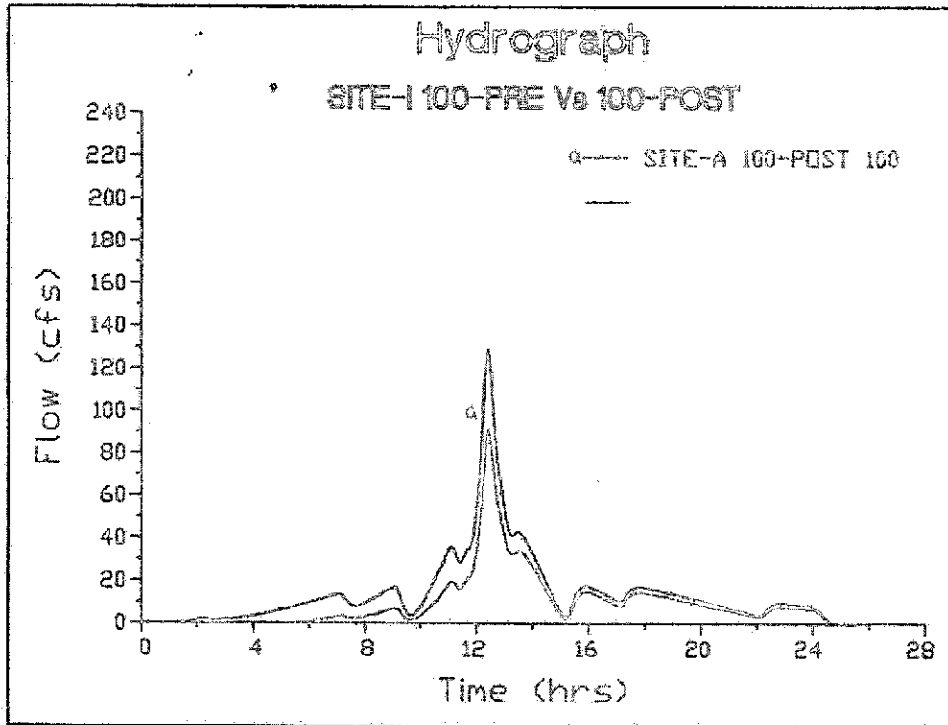

ALTERNATE "SITE-III"

1. 100yr Pre-development
Hydrograph
2. 100yr Post-Development
Hydrograph
3. Detention Storage Estimate
Hydrograph

PRE-DEVELOPMENT

Type.... SCS Unit Hyd. Summary
Name.... SITE-B 100-PRE Tag: 100
File.... S:\A03068\HYDRO\NW-100YR.PPK

Page 3.03
Event: 100 yr

SCS UNIT HYDROGRAPH METHOD

STORM EVENT: 100 year storm
Duration = 24.0000 hrs Rain Depth = 5.2320 in
Rain Dir = S:\HAESTAD\PPK6\
Rain File -ID = 100-YR.RNF - Depth Tbl 100YR
Unit Hyd Type = Default Curvilinear
HYG Dir = S:\A03068\HYDRO\
HYG File - ID = NW-100YR.HYG - SITE-B 100-PRE 100
Tc = .5000 hrs
Drainage Area = 100.400 acres Runoff CN= 78

=====
Computational Time Increment = .06667 hrs
Computed Peak Time = 12.4000 hrs
Computed Peak Flow = 111.48 cfs

Time Increment for HYG File = .0500 hrs
Peak Time, Interpolated Output = 12.4000 hrs
Peak Flow, Interpolated Output = 111.48 cfs
=====

DRAINAGE AREA

ID:None Selected
CN = 78
Area = 100.400 acres
S = 2.8205 in
0.2S = .5641 in

Cumulative Runoff

2.9097 in
24.345 ac-ft

HYG Volume... 24.344 ac-ft (area under HYG curve)

***** UNIT HYDROGRAPH PARAMETERS *****

Time Concentration, Tc = .50000 hrs (ID: None Selected)
Computational Incr, Tm = .06667 hrs = 0.20000 Tp

Unit Hyd. Shape Factor = 483.432 (37.46% under rising limb)
K = 483.43/645.333, K = .7491 (also, K = 2/(1+(Tr/Tp))
Receding/Rising, Tr/Tp = 1.6698 (solved from K = .7491)

Unit peak, qp = 237.52 cfs
Unit peak time Tp = .33333 hrs
Unit receding limb, Tr = 1.33333 hrs
Total unit time, Tb = 1.66667 hrs

Type.... SCS Unit Hyd. (HYG output)
 Name.... SITE-B 100-PRE Tag: 100
 File.... S:\A03068\HYDRO\NW-100YR.PPK

Page 3.04
 Event: 100 yr

SCS UNIT HYDROGRAPH METHOD

STORM EVENT: 100 year storm
 Duration = 24.0000 hrs Rain Depth = 5.2320 in
 Rain Dir = S:\HAESTAD\PPK6\
 Rain File -ID = 100-YR.RNF - Depth Tbl 100YR
 Unit Hyd Type = Default Curvilinear
 HYG Dir = S:\A03068\HYDRO\
 HYG File - ID = NW-100YR.HYG - SITE-B 100-PRE 100
 Tc = .5000 hrs
 Drainage Area = 100,400 acres Runoff CN= 78
 Calc.Increment= .06667 hrs Out.Incr.= .0500 hrs
 HYG Volume = 24.344 ac-ft

HYDROGRAPH ORDINATES (cfs)

Output Time increment = .0500 hrs
 Time on left represents time for first value in each row.

Time hrs						
5.5000	.00	.00	.01	.02	.04	
5.7500	.07	.12	.18	.25	.33	
6.0000	.42	.52	.63	.74	.86	
6.2500	.98	1.11	1.24	1.37	1.51	
6.5000	1.65	1.79	1.94	2.09	2.24	
6.7500	2.40	2.56	2.72	2.88	3.05	
7.0000	3.22	3.36	3.44	3.47	3.41	
7.2500	3.25	3.07	2.89	2.71	2.59	
7.5000	2.51	2.48	2.49	2.53	2.60	
7.7500	2.68	2.78	2.90	3.03	3.18	
8.0000	3.32	3.48	3.65	3.82	4.00	
8.2500	4.20	4.39	4.59	4.80	5.02	
8.5000	5.24	5.47	5.70	5.95	6.20	
8.7500	6.45	6.71	6.98	7.25	7.53	
9.0000	7.82	7.99	8.00	7.79	7.29	
9.2500	6.46	5.54	4.60	3.69	2.94	
9.5000	2.37	1.98	1.74	1.70	1.77	
9.7500	1.94	2.21	2.60	3.05	3.56	
10.0000	4.11	4.72	5.36	6.03	6.73	
10.2500	7.47	8.23	9.02	9.83	10.67	
10.5000	11.53	12.43	13.36	14.32	15.30	
10.7500	16.32	17.35	18.44	19.55	20.69	
11.0000	21.85	22.79	23.35	23.44	22.94	
11.2500	21.85	20.80	19.97	19.53	19.88	
11.5000	20.81	22.12	23.63	24.68	25.48	
11.7500	26.24	27.21	29.45	32.61	36.55	
12.0000	41.12	47.48	55.68	65.89	78.32	
12.2500	91.43	101.92	108.90	111.48	108.40	
12.5000	102.65	95.13	86.73	79.55	73.77	
12.7500	69.10	65.26	61.80	58.28	54.66	
13.0000	50.87	47.14	43.90	41.41	39.92	
13.2500	39.74	40.03	40.62	41.32	41.85	

Type.... SCS Unit Hyd. (HYG output)
 Name.... SITE-B 100-PRE Tag: 100
 File.... S:\A03068\HYDRO\NW-100YR.PPK

Page 3.05
 Event: 100 yr

HYDROGRAPH ORDINATES (cfs)

Output Time increment = .0500 hrs

Time on left represents time for first value in each row.

Time hrs					
13.5000	42.01	41.84	41.38	40.65	39.82
13.7500	38.89	37.88	36.76	35.59	34.36
14.0000	33.10	31.78	30.44	29.08	27.70
14.2500	26.28	24.86	23.43	21.99	20.55
14.5000	19.09	17.62	16.13	14.65	13.16
14.7500	11.67	10.20	8.74	7.34	6.03
15.0000	4.83	3.94	3.31	2.99	3.06
15.2500	3.76	4.87	6.37	8.22	10.25
15.5000	12.16	13.88	15.36	16.42	17.20
15.7500	17.74	18.07	18.20	18.23	18.16
16.0000	18.03	17.82	17.58	17.30	16.99
16.2500	16.66	16.31	15.94	15.57	15.18
16.5000	14.79	14.38	13.97	13.56	13.14
16.7500	12.71	12.29	11.87	11.44	11.01
17.0000	10.59	10.31	10.24	10.45	11.01
17.2500	11.98	13.05	14.14	15.19	16.06
17.5000	16.73	17.23	17.57	17.78	17.92
17.7500	18.01	18.05	18.03	17.98	17.90
18.0000	17.81	17.70	17.58	17.45	17.32
18.2500	17.17	17.02	16.87	16.71	16.55
18.5000	16.39	16.23	16.06	15.90	15.73
18.7500	15.57	15.40	15.23	15.06	14.88
19.0000	14.71	14.55	14.38	14.21	14.04
19.2500	13.87	13.70	13.53	13.36	13.19
19.5000	13.02	12.84	12.66	12.49	12.32
19.7500	12.15	11.98	11.80	11.63	11.45
20.0000	11.28	11.10	10.93	10.75	10.57
20.2500	10.40	10.22	10.04	9.86	9.69
20.5000	9.51	9.33	9.16	8.98	8.81
20.7500	8.63	8.45	8.27	8.09	7.91
21.0000	7.74	7.56	7.38	7.21	7.03
21.2500	6.85	6.67	6.50	6.32	6.14
21.5000	5.96	5.78	5.60	5.42	5.24
21.7500	5.06	4.89	4.71	4.53	4.34
22.0000	4.16	4.08	4.13	4.37	4.84
22.2500	5.57	6.35	7.15	7.90	8.53
22.5000	9.02	9.39	9.65	9.82	9.94
22.7500	10.02	10.06	10.07	10.05	10.02
23.0000	9.98	9.92	9.86	9.80	9.72
23.2500	9.64	9.56	9.48	9.40	9.31
23.5000	9.23	9.14	9.05	8.95	8.86
23.7500	8.76	8.67	8.57	8.48	8.39
24.0000	8.29	8.12	7.83	7.38	6.74
24.2500	5.88	4.99	4.10	3.27	2.57
24.5000	2.00	1.55	1.20	.95	.74
24.7500	.58	.45	.35	.27	.21
25.0000	.16	.13	.10	.07	.05

Type.... SCS Unit Hyd. (HYG output)
Name.... SITE-B 100-PRE Tag: 100
File.... S:\A03068\HYDRO\NW-100YR.PPK

Page 3.06
Event: 100 yr

HYDROGRAPH ORDINATES (cfs)
Output Time increment = .0500 hrs
Time on left represents time for first value in each row.

Time hrs					
25.2500	.04	.03	.02	.01	
25.5000	.00	.00	.00		.01

POST-DEVELOPMENT

Type.... SCS Unit Hyd. Summary
Name.... SITE-B 100-POST Tag: 100
File.... S:\A03068\HYDRO\NW-100YR.PPK

Page 3.03
Event: 100 yr

SCS UNIT HYDROGRAPH METHOD

STORM EVENT: 100 year storm
Duration = 24.0000 hrs Rain Depth = 5.2320 in
Rain Dir = S:\HAESTAD\PPK6\
Rain File -ID = 100-YR.RNF - Depth Tbl 100YR
Unit Hyd Type = Default Curvilinear
HYG Dir = S:\A03068\HYDRO\
HYG File - ID = NW-100YR.HYG - SITE-B 100-POST 100
Tc = .5000 hrs
Drainage Area = 100.400 acres Runoff CN= 95

=====
Computational Time Increment = .06667 hrs
Computed Peak Time = 12.4000 hrs
Computed Peak Flow = 164.44 cfs

Time Increment for HYG File = .0500 hrs
Peak Time, Interpolated Output = 12.4000 hrs
Peak Flow, Interpolated Output = 164.44 cfs
=====

DRAINAGE AREA

ID:None Selected
CN = 95
Area = 100.400 acres
S = .5263 in
0.2S = .1053 in

Cumulative Runoff

4.6494 in
38.900 ac-ft

HYG Volume... 38.900 ac-ft (area under HYG curve)

***** UNIT HYDROGRAPH PARAMETERS *****

Time Concentration, Tc = .50000 hrs (ID: None Selected)
Computational Incr, Tm = .06667 hrs = 0.20000 Tp

Unit Hyd. Shape Factor = 483.432 (37.46% under rising limb)
K = 483.43/645.333, K = .7491 (also, K = 2/(1+(Tr/Tp))
Receding/Rising, Tr/Tp = 1.6698 (solved from K = .7491)

Unit peak, qp = 227.52 cfs
Unit peak time Tp = .33333 hrs
Unit receding limb, Tr = 1.33333 hrs
Total unit time, Tb = 1.66667 hrs

S/N: HOM0L0102006 Robert A. Karn & Associates, Inc.
Pond Pack Ver: 8-01-98 (61) Compute Time: 15:43:58

Date: 01-19-2004

Type.... SCS Unit Hyd. (HYG output)
 Name.... SITE-B 100-POST Tag: 100
 File.... S:\A03068\HYDRO\NW-100YR.PPK

Page 3.04
 Event: 100 yr

SCS UNIT HYDROGRAPH METHOD

STORM EVENT: 100 year storm
 Duration = 24.0000 hrs Rain Depth = 5.2320 in
 Rain Dir = S:\HAESTAD\PPK6\
 Rain File -ID = 100-YR.RNF - Depth Tbl 100YR
 Unit Hyd Type = Default Curvilinear
 HYG Dir = S:\A03068\HYDRO\
 HYG File - ID = NW-100YR.HYG - SITE-B 100-POST 100
 Tc = .5000 hrs
 Drainage Area = 100.400 acres Runoff CN= 95
 Calc.Increment= .06667 hrs Out.Incr.= .0500 hrs
 HYG Volume = 38.900 ac-ft

HYDROGRAPH ORDINATES (cfs)

Output Time increment = .0500 hrs
 Time on left represents time for first value in each row.

Time hrs					
1.1000	.00	.00	.01	.03	.07
1.3500	.12	.20	.31	.44	.58
1.6000	.75	.93	1.12	1.32	1.52
1.8500	1.73	1.94	2.15	2.37	2.55
2.1000	2.68	2.73	2.70	2.55	2.37
2.3500	2.18	1.99	1.84	1.73	1.66
2.6000	1.63	1.64	1.66	1.70	1.75
2.8500	1.81	1.89	1.97	2.06	2.16
3.1000	2.26	2.36	2.47	2.59	2.71
3.3500	2.83	2.95	3.09	3.22	3.36
3.6000	3.50	3.64	3.79	3.94	4.09
3.8500	4.25	4.41	4.57	4.74	4.91
4.1000	5.08	5.26	5.44	5.62	5.80
4.3500	5.99	6.17	6.36	6.55	6.75
4.6000	6.95	7.15	7.35	7.56	7.77
4.8500	7.98	8.19	8.41	8.62	8.84
5.1000	9.06	9.28	9.50	9.73	9.96
5.3500	10.18	10.41	10.65	10.88	11.11
5.6000	11.34	11.58	11.81	12.05	12.28
5.8500	12.52	12.76	13.00	13.24	13.49
6.1000	13.74	13.98	14.23	14.48	14.72
6.3500	14.96	15.21	15.45	15.69	15.94
6.6000	16.19	16.44	16.69	16.94	17.19
6.8500	17.44	17.69	17.94	18.20	18.30
7.1000	18.19	17.81	17.08	15.97	14.80
7.3500	13.64	12.58	11.77	11.19	10.84
7.6000	10.66	10.67	10.75	10.91	11.14
7.8500	11.43	11.77	12.13	12.51	12.92
8.1000	13.35	13.78	14.23	14.69	15.16
8.3500	15.63	16.11	16.59	17.08	17.57
8.6000	18.07	18.58	19.08	19.59	20.09
8.8500	20.60	21.12	21.63	22.14	22.35

Type.... SCS Unit Hyd. (HYG output)
 Name.... SITE-B 100-POST Tag: 100
 File.... S:\A03068\HYDRO\NW-100YR.PPK

Page 3.05
 Event: 100 yr

HYDROGRAPH ORDINATES (cfs)

Output Time increment = .0500 hrs

Time on left represents time for first value in each row.

Time hrs					
9.1000	22.14	21.35	19.85	17.50	14.96
9.3500	12.39	9.93	7.90	6.37	5.29
9.6000	4.63	4.48	4.61	5.02	5.67
9.8500	6.61	7.72	8.95	10.27	11.71
10.1000	13.20	14.74	16.33	17.99	19.65
10.3500	21.33	23.03	24.74	26.48	28.24
10.6000	30.02	31.80	33.60	35.40	37.20
10.8500	39.02	40.86	42.71	44.54	45.88
11.1000	46.52	46.24	44.85	42.41	40.05
11.3500	38.11	36.91	37.15	38.43	40.41
11.6000	42.75	44.26	45.30	46.24	47.50
11.8500	50.79	55.53	61.46	68.32	77.71
12.1000	89.59	104.18	121.71	139.71	153.61
12.3500	162.25	164.44	158.55	148.93	136.92
12.6000	123.83	112.74	103.73	96.41	90.36
12.8500	85.01	79.69	74.32	68.82	63.49
13.1000	58.87	55.27	53.04	52.55	52.69
13.3500	53.24	53.95	54.45	54.49	54.11
13.6000	53.36	52.28	51.08	49.76	48.36
13.8500	46.84	45.25	43.60	41.93	40.19
14.1000	38.43	36.66	34.86	33.03	31.20
14.3500	29.38	27.54	25.71	23.86	22.00
14.6000	20.12	18.26	16.40	14.54	12.69
14.8500	10.88	9.14	7.50	6.01	4.90
15.1000	4.11	3.72	3.80	4.66	6.04
15.3500	7.89	10.17	12.68	15.02	17.14
15.6000	18.96	20.26	21.21	21.85	22.25
15.8500	22.39	22.41	22.32	22.14	21.86
16.1000	21.55	21.19	20.80	20.38	19.94
16.3500	19.48	19.01	18.53	18.04	17.53
16.6000	17.02	16.51	15.99	15.47	14.94
16.8500	14.42	13.89	13.37	12.85	12.50
17.1000	12.41	12.66	13.33	14.50	15.78
17.3500	17.09	18.35	19.39	20.19	20.78
17.6000	21.18	21.42	21.58	21.67	21.70
17.8500	21.66	21.59	21.49	21.37	21.22
18.1000	21.06	20.90	20.72	20.53	20.34
18.3500	20.15	19.95	19.75	19.55	19.35
18.6000	19.14	18.93	18.72	18.51	18.31
18.8500	18.09	17.88	17.67	17.46	17.25
19.1000	17.04	16.84	16.63	16.42	16.21
19.3500	16.00	15.80	15.59	15.38	15.17
19.6000	14.95	14.74	14.53	14.32	14.12
19.8500	13.91	13.70	13.49	13.28	13.06
20.1000	12.85	12.64	12.43	12.22	12.01
20.3500	11.80	11.58	11.37	11.16	10.95
20.6000	10.74	10.53	10.32	10.12	9.91

Type.... SCS Unit Hyd. (HYG output)
 Name.... SITE-B 100-POST Tag: 100
 File.... S:\A03068\HYDRO\NW-100YR.PPK

Page 3.06
 Event: 100 yr

HYDROGRAPH ORDINATES (cfs)
 Output Time increment = .0500 hrs
 Time on left represents time for first value in each row.

Time hrs					
20.8500	9.69	9.48	9.27	9.06	8.85
21.1000	8.64	8.43	8.22	8.01	7.80
21.3500	7.60	7.39	7.18	6.97	6.76
21.6000	6.54	6.33	6.12	5.91	5.71
21.8500	5.50	5.28	5.07	4.86	4.76
22.1000	4.82	5.10	5.64	6.49	7.41
22.3500	8.33	9.21	9.94	10.50	10.93
22.6000	11.24	11.43	11.57	11.66	11.71
22.8500	11.71	11.69	11.65	11.60	11.53
23.1000	11.46	11.38	11.29	11.20	11.10
23.3500	11.00	10.90	10.80	10.70	10.59
23.6000	10.48	10.37	10.26	10.15	10.04
23.8500	9.93	9.81	9.70	9.60	9.39
24.1000	9.05	8.53	7.79	6.80	5.77
24.3500	4.74	3.78	2.97	2.31	1.79
24.6000	1.39	1.10	.86	.67	.52
24.8500	.40	.32	.24	.19	.14
25.1000	.11	.08	.06	.05	.03
25.3500	.02	.02	.01	.01	.00
25.6000	.00				

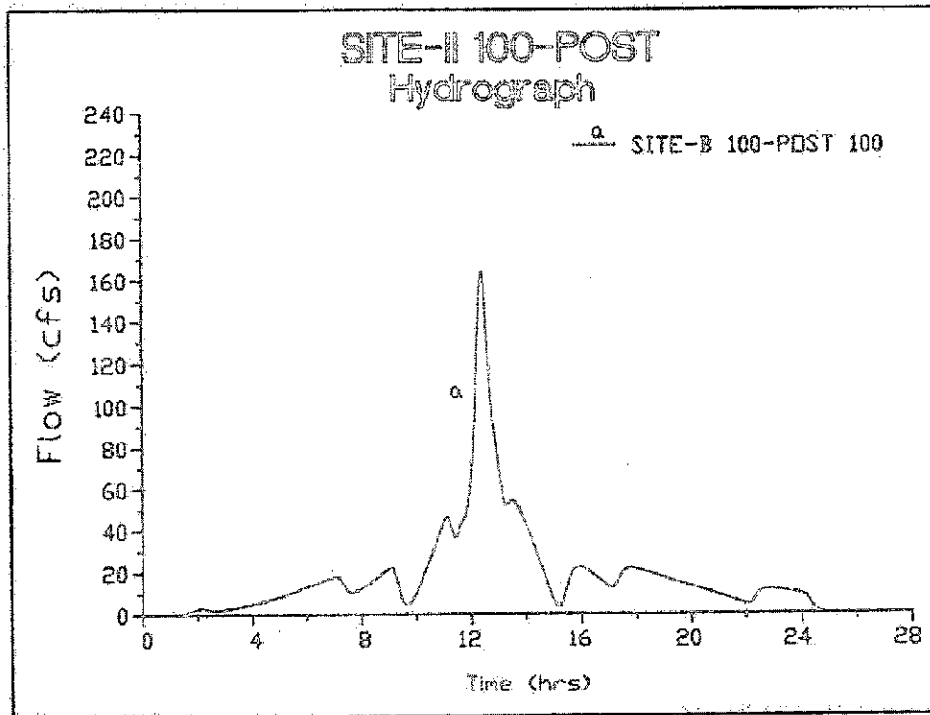
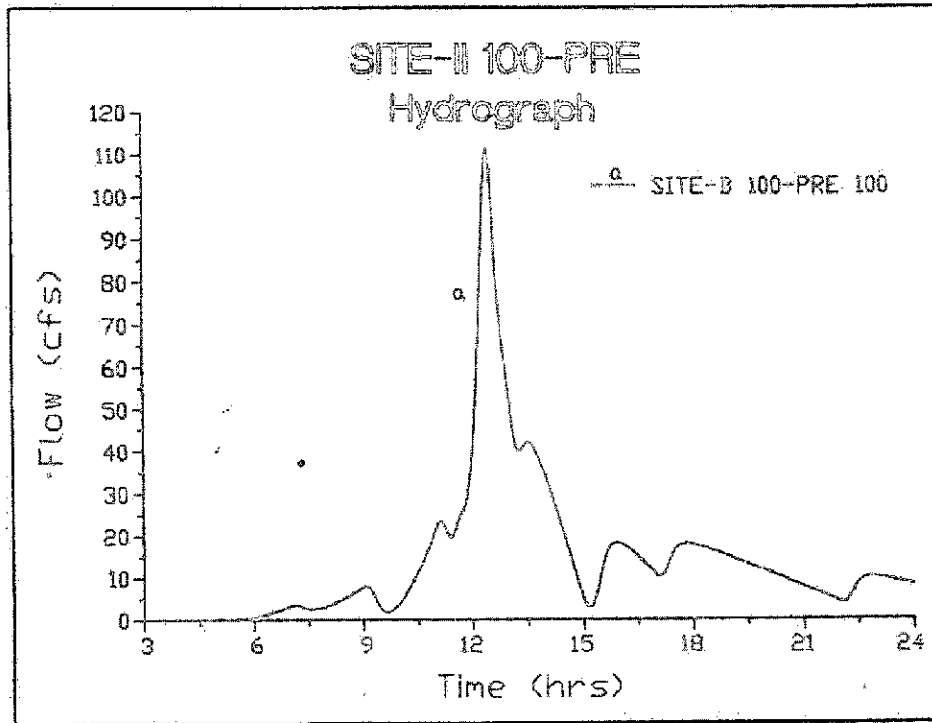

HYDRO/PRE-POST-B

STORAGE ESTIMATE

Type.... Vol.Est: Overlay Est.
Name.... VOL.SITE-B

Page 2.01

File.... S:\A03068\HYDRO\NW-100YR.PPK
Title... PRE DEVELOPED vs DEVELOPED

DETENTION STORAGE ESTIMATE
(Estimated by overlaying hydrographs)

INFLOW HYDROGRAPH...
HYG file = NW-100YR.HYG
HYG ID = SITE-B 100-POST
HYG Tag = 100

OVERLAY HYDROGRAPH...
HYG file = NW-100YR.HYG
HYG ID = SITE-B 100-PRE
HYG Tag = 100

Estimate Type	Est.Storage ac-ft	From hrs	To hrs
Overlay HYG	14.555	1.1000	25.6000

SITE-II 100-POST vs 100 PRE Hydrograph

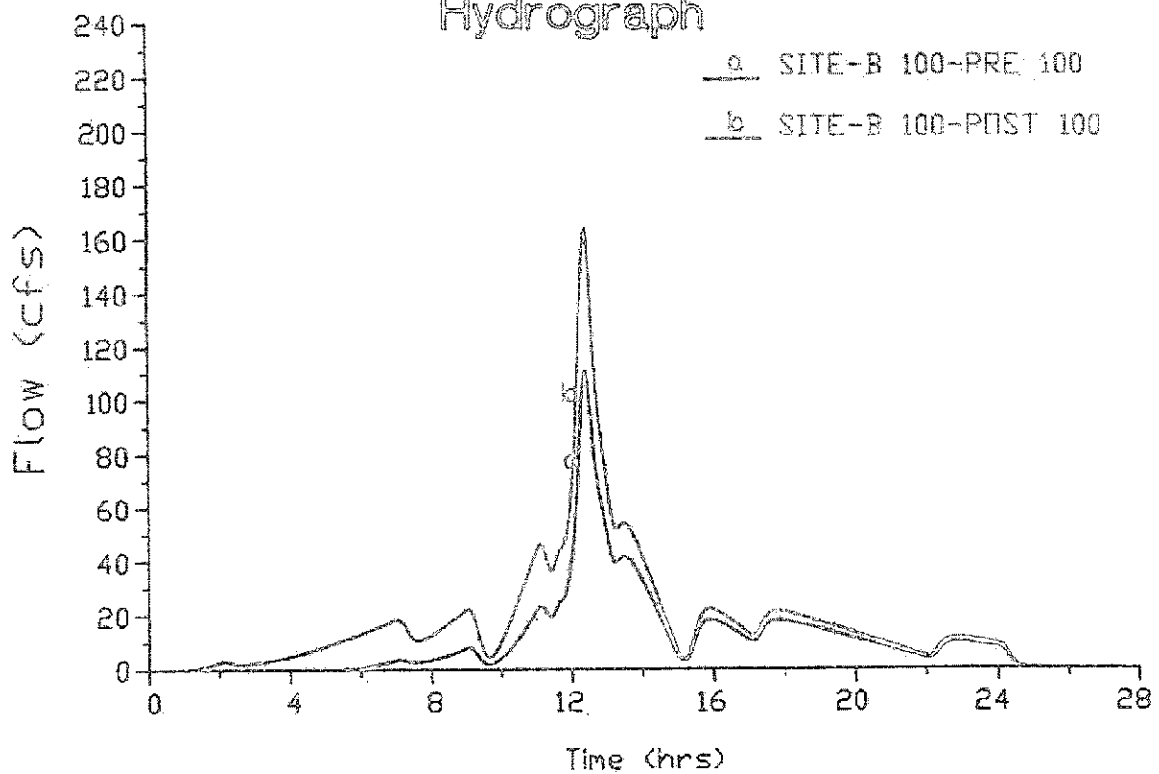

ALTERNATE "SITE-IV"

1. 100yr Pre-development
Hydrograph
2. 100yr Post-Development
Hydrograph
3. Detention Storage Estimate
Hydrograph

Type.... Design Storms
Name.... STORMS 100
File.... S:\HAESTAD\PPK6\SCSMET~1.RNQ

Page 1.01
Storm:

DESIGN STORMS SUMMARY

Design Storm File, ID = SCSMET~1.RNQ STORMS 100

Storm Tag Name = 100
Description: SONOMA COUNTY

Data Type, File, ID = Time-Depth Curve 100-YR.RNF Tbl 100YR(MAP25)
Storm Frequency = 100 yr
Total Rainfall Depth= 4.3944 in
Duration Multiplier = 1
Resulting Duration = 24.0000 hrs
Resulting Start Time= .0000 hrs Step= .1667 hrs End= 24.0000 hrs

SITE-III

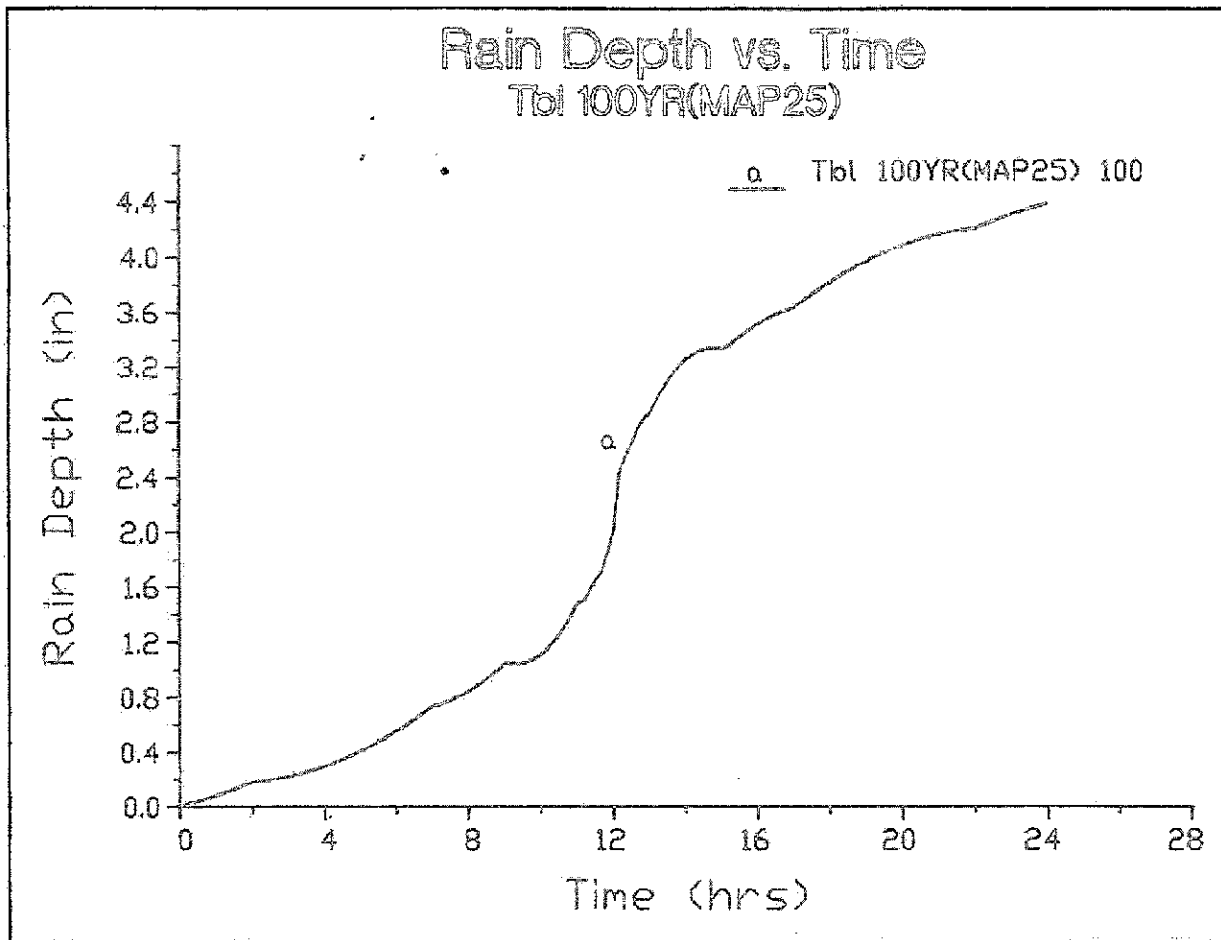

Type.... Time-Depth Curve
 Name.... Tbl 100YR(MAP25) Tag: 100
 File.... S:\HAESTAD\PPK6\100-YR.RNF
 Title... SONOMA COUNTY

Page 2.01
 Event: 100 yr

SYNTHETIC CUMULATIVE RAINFALL(in)
 Output Time increment = .1667 hrs
 Time on left represents time for first value in each row.

Time hrs						
.0000	.0000	.0121	.0248	.0380	.0517	
.8333	.0659	.0806	.0958	.1115	.1278	
1.6667	.1446	.1619	.1797	.1841	.1895	
2.5000	.1959	.2033	.2117	.2210	.2314	
3.3333	.2427	.2549	.2682	.2825	.2977	
4.1667	.3139	.3311	.3492	.3684	.3885	
5.0000	.4096	.4317	.4548	.4788	.5038	
5.8333	.5298	.5568	.5848	.6137	.6437	
6.6667	.6746	.7064	.7393	.7515	.7661	
7.5000	.7831	.8027	.8246	.8490	.8759	
8.3333	.9052	.9370	.9712	1.0078	1.0470	
9.1667	1.0470	1.0470	1.0509	1.0636	1.0850	
10.0000	1.1152	1.1541	1.2018	1.2583	1.3235	
10.8333	1.3974	1.4801	1.5057	1.5641	1.6551	
11.6667	1.7017	1.8427	2.0098	2.4271	2.5483	
12.5000	2.6421	2.7494	2.8241	2.8661	2.9531	
13.3333	3.0315	3.1010	3.1618	3.2139	3.2572	
14.1667	3.2918	3.3176	3.3346	3.3430	3.3430	
15.0000	3.3430	3.3553	3.3932	3.4286	3.4616	
15.8333	3.4921	3.5202	3.5459	3.5691	3.5898	
16.6667	3.6081	3.6239	3.6373	3.6707	3.7030	
17.5000	3.7344	3.7648	3.7943	3.8227	3.8502	
18.3333	3.8767	3.9022	3.9268	3.9503	3.9729	
19.1667	3.9945	4.0151	4.0347	4.0534	4.0711	
20.0000	4.0878	4.1035	4.1182	4.1320	4.1447	
20.8333	4.1565	4.1673	4.1772	4.1860	4.1939	
21.6667	4.2008	4.2067	4.2117	4.2297	4.2473	
22.5000	4.2643	4.2808	4.2968	4.3123	4.3273	
23.3333	4.3417	4.3557	4.3691	4.3820	4.3944	

SCS UNIT HYDROGRAPH METHOD
(Computational Notes)

DEFINITION OF TERMS: -----

- At = Total area (acres): $At = Ai + Ap$
Ai = Impervious area (acres)
Ap = Pervious area (acres)
CNI = Runoff curve number for impervious area
CNP = Runoff curve number for pervious area
fLoss = f loss constant infiltration (depth/time)
dt = Computational increment (duration of unit excess rainfall)
Default dt is smallest value of $0.1333Tc$, rtm, and th
(Smallest dt is then adjusted to match up with Tp)
UDdt = User specified override computational main time increment
(only used if UDdt is $\Rightarrow .1333Tc$)
D(t) = Point on distribution curve (fraction of P) for time step t
K = $2 / (1 + (Tr/Tp))$: default K = 0.75: (for $Tr/Tp = 1.67$)
Ks = Hydrograph shape factor
= Unit Conversions * K:
= $((1hr/3600sec) * (1ft/12in) * ((5280ft)**2/sq.mi)) * K$
Default Ks = $645.333 * 0.75 = 484$
Lag = Lag time from center of excess runoff (dt) to Tp: $Lag = 0.6Tc$
P = Total precipitation depth, inches
Pa(t) = Accumulated rainfall at time step t
Pi(t) = Incremental rainfall at time step t
qp = Peak discharge (cfs) for lin. runoff, for 1hr, for 1 sq.mi.
= $(Ks * A * Q) / Tp$ (where Q = lin. runoff, A=sq.mi.)
Qu(t) = Unit hydrograph ordinate (cfs) at time step t
Q(t) = Final hydrograph ordinate (cfs) at time step t
Rai(t) = Accumulated runoff (inches) at time step t for impervious area
Rap(t) = Accumulated runoff (inches) at time step t for pervious area
Rii(t) = Incremental runoff (inches) at time step t for impervious area
Rip(t) = Incremental runoff (inches) at time step t for pervious area
R(t) = Incremental weighted total runoff (inches)
Rtm = Time increment for rainfall table (.RNF file)
Si = S for impervious area: $Si = (1000/CNI) - 10$
Sp = S for pervious area: $Sp = (1000/CNP) - 10$
t = Time step (row) number
Tc = Time of concentration
Tb = Time (hrs) of entire unit hydrograph: $Tb = Tp + Tr$
Tp = Time (hrs) to peak of a unit hydrograph: $Tp = (dt/2) + Lag$
Tr = Time (hrs) of receding limb of unit hydrograph: $Tr = ratio\ of\ Tp$

Type.... SCS Unit Hyd. Equations
Name....
File.... S:\A03068\HYDRO\LAKE-100.PPK

Page 3.02

SCS UNIT HYDROGRAPH METHOD
(Computational Notes)

PRECIPITATION: -----

Column (1): Time for time step t
Column (2): D(t) = Point on distribution curve for time step t
Column (3): Pi(t) = Pa(t) - Pa(t-1): Col.(4) - Preceding Col.(4)
Column (4): Pa(t) = D(t) x P: Col.(2) x P

PERVIOUS AREA RUNOFF (using SCS Runoff CN Method) -----

Column (5): Rap(t) = Accumulated pervious runoff for time step t
If (Pa(t) is <= 0.2Sp) then use: Rap(t) = 0.0
If (Pa(t) is > 0.2Sp) then use:

$$\text{Rap}(t) = (\text{Col.}(4) - 0.2\text{Sp})^{**2} / (\text{Col.}(4) + 0.8\text{Sp})$$

Column (6): Rip(t) = Incremental pervious runoff for time step t
Rip(t) = Rap(t) - Rap(t-1)
Rip(t) = Col.(5) for current row - Col.(5) for preceding row.

IMPERVIOUS AREA RUNOFF -----

Column (7 & 8)... Did not specify to use impervious areas.

INCREMENTAL WEIGHTED RUNOFF: -----

Column (9): R(t) = (Ap/At) x Rip(t) + (Ai/At) x Rii(t)
R(t) = (Ap/At) x Col.(6) + (Ai/At) x Col.(8)

SCS UNIT HYDROGRAPH METHOD: -----

Column (10): Q(t) is computed with the SCS unit hydrograph method
using R() and Qu().

PRE-DEVELOPMENT

Type.... SCS Unit Hyd. Summary
Name.... SITE-E 100-PRE Tag: 100
File.... S:\A03068\HYDRO\LAKE-100.PPK

Page 3.03
Event: 100 yr

SCS UNIT HYDROGRAPH METHOD

STORM EVENT: 100 year storm
Duration = 24.0000 hrs Rain Depth = 4.3944 in
Rain Dir = S:\HAESTAD\PPK6\
Rain File -ID = 100-YR.RNF - Tbl 100YR(MAP25)
Unit Hyd Type = Default Curvilinear
HYG Dir = S:\A03068\HYDRO\
HYG File - ID = LAKE-100.HYG - SITE-E 100-PRE 100
Tc = .5000 hrs
Drainage Area = 76.700 acres Runoff CN= 78

=====
Computational Time Increment = .06667 hrs
Computed Peak Time = 12.4000 hrs
Computed Peak Flow = 64.31 cfs

Time Increment for HYG File = .0500 hrs
Peak Time, Interpolated Output = 12.4000 hrs
Peak Flow, Interpolated Output = 64.31 cfs
=====

DRAINAGE AREA

ID:None Selected
CN = 78
Area = 76.700 acres
S = 2.8205 in
0.2S = .5641 in

Cumulative Runoff

2.2059 in
14.100 ac-ft

HYG Volume.... 14.099 ac-ft (area under HYG curve)

***** UNIT HYDROGRAPH PARAMETERS *****

Time Concentration, Tc = .50000 hrs (ID: None Selected)
Computational Incr, Tm = .06667 hrs = 0.20000 Tp

Unit Hyd. Shape Factor = 483.432 (37.46% under rising limb)
K = 483.43/645.333, K = .7491 (also, K = 2/(1+(Tr/Tp))
Receding/Rising, Tr/Tp = 1.6698 (solved from K = .7491)

Unit peak, qp = 173.81 cfs
Unit peak time Tp = .33333 hrs
Unit receding limb, Tr = 1.33333 hrs
Total unit time, Tb = 1.66667 hrs

Type.... SCS Unit Hyd. (HYG output)
 Name.... SITE-E 100-PRE Tag: 100
 File.... S:\A03068\HYDRO\LAKE-100.PPK

Page 3.04
 Event: 100 yr

SCS UNIT HYDROGRAPH METHOD

STORM EVENT: 100 year storm
 Duration = 24.0000 hrs Rain Depth = 4.3944 in
 Rain Dir = S:\HAESTAD\PPK6\
 Rain File -ID = 100-YR.RNF - Tbl 100YR(MAP25)
 Unit Hyd Type = Default Curvilinear
 HYG Dir = S:\A03068\HYDRO\
 HYG File - ID = LAKE-100.HYG - SITE-E 100-PRE 100
 Tc = .5000 hrs
 Drainage Area = 76.700 acres Runoff CN= 78
 Calc.Increment= .06667 hrs Out.Incr.= .0500 hrs
 HYG Volume = 14.099 ac-ft

HYDROGRAPH ORDINATES (cfs)

Output Time increment = .0500 hrs
 Time on left represents time for first value in each row.

Time hrs					
6.1000	.00	.00	.01	.02	.04
6.3500	.06	.10	.14	.20	.26
6.6000	.32	.39	.47	.54	.63
6.8500	.71	.80	.89	.98	1.06
7.1000	1.12	1.16	1.17	1.13	1.09
7.3500	1.04	.99	.96	.94	.94
7.6000	.96	.99	1.03	1.07	1.12
7.8500	1.18	1.25	1.32	1.39	1.47
8.1000	1.55	1.64	1.73	1.82	1.92
8.3500	2.02	2.13	2.24	2.35	2.47
8.6000	2.60	2.72	2.85	2.99	3.13
8.8500	3.27	3.42	3.57	3.72	3.83
9.1000	3.85	3.76	3.53	3.13	2.69
9.3500	2.24	1.80	1.43	1.15	.96
9.6000	.85	.83	.87	.95	1.09
9.8500	1.29	1.52	1.77	2.05	2.36
10.1000	2.68	3.03	3.38	3.77	4.16
10.3500	4.57	5.00	5.45	5.91	6.39
10.6000	6.89	7.41	7.95	8.51	9.08
10.8500	9.68	10.30	10.94	11.59	12.13
11.1000	12.47	12.55	12.31	11.75	11.21
11.3500	10.79	10.58	10.80	11.34	12.09
11.6000	12.95	13.55	14.02	14.47	15.04
11.8500	16.33	18.15	20.42	23.06	26.76
12.1000	31.53	37.48	44.73	52.41	58.58
12.3500	62.72	64.31	62.60	59.36	55.09
12.6000	50.31	46.23	42.96	40.32	38.17
12.8500	36.21	34.21	32.13	29.94	27.78
13.1000	25.90	24.46	23.61	23.53	23.73
13.3500	24.11	24.55	24.88	25.00	24.92
13.6000	24.66	24.24	23.76	23.22	22.62
13.8500	21.97	21.28	20.56	19.81	19.04

Type.... SCS Unit Hyd. (HYG output)
 Name.... SITE-E 100-PRE Tag: 100
 File.... S:\A03068\HYDRO\LAKE-100.PPK

Page 3.05
 Event: 100 yr

HYDROGRAPH ORDINATES (cfs)
 Output Time increment = .0500 hrs
 Time on left represents time for first value in each row.

Time hrs					
14.1000	18.24	17.44	16.61	15.77	14.92
14.3500	14.07	13.21	12.34	11.47	10.59
14.6000	9.69	8.80	7.91	7.02	6.14
14.8500	5.26	4.42	3.63	2.91	2.38
15.1000	1.99	1.80	1.84	2.26	2.93
15.3500	3.83	4.95	6.17	7.32	8.36
15.6000	9.25	9.89	10.36	10.69	10.89
15.8500	10.97	10.99	10.96	10.88	10.76
16.1000	10.61	10.45	10.27	10.06	9.86
16.3500	9.64	9.41	9.18	8.94	8.70
16.6000	8.45	8.20	7.95	7.69	7.44
16.8500	7.18	6.92	6.66	6.41	6.24
17.1000	6.20	6.33	6.67	7.26	7.91
17.3500	8.57	9.20	9.73	10.13	10.44
17.6000	10.65	10.78	10.87	10.92	10.94
17.8500	10.93	10.91	10.87	10.82	10.75
18.1000	10.68	10.60	10.52	10.43	10.34
18.3500	10.25	10.16	10.07	9.97	9.87
18.6000	9.78	9.68	9.58	9.48	9.38
18.8500	9.28	9.17	9.07	8.96	8.86
19.1000	8.76	8.66	8.55	8.45	8.35
19.3500	8.24	8.14	8.03	7.93	7.82
19.6000	7.72	7.61	7.51	7.41	7.30
19.8500	7.20	7.09	6.99	6.88	6.78
20.1000	6.67	6.56	6.46	6.35	6.24
20.3500	6.13	6.02	5.92	5.81	5.70
20.6000	5.59	5.49	5.38	5.27	5.16
20.8500	5.05	4.94	4.83	4.72	4.62
21.1000	4.51	4.40	4.30	4.19	4.08
21.3500	3.97	3.86	3.75	3.64	3.53
21.6000	3.42	3.31	3.20	3.09	2.99
21.8500	2.88	2.77	2.66	2.55	2.50
22.1000	2.53	2.68	2.96	3.41	3.89
22.3500	4.37	4.83	5.22	5.52	5.74
22.6000	5.90	6.00	6.08	6.13	6.15
22.8500	6.15	6.15	6.13	6.11	6.07
23.1000	6.04	6.00	5.95	5.91	5.86
23.3500	5.80	5.75	5.70	5.64	5.59
23.6000	5.53	5.48	5.42	5.36	5.31
23.8500	5.25	5.19	5.13	5.07	4.97
24.1000	4.79	4.51	4.12	3.60	3.05
24.3500	2.51	2.00	1.57	1.22	.95
24.6000	.74	.58	.46	.35	.27
24.8500	.21	.17	.13	.10	.08
25.1000	.06	.04	.03	.02	.02
25.3500	.01	.01	.01	.00	.00
25.6000	.00				

POST-DEVELOPMENT

Type.... SCS Unit Hyd. Summary
Name.... SITE-E 100-POST Tag: 100
File.... S:\A03068\HYDRO\LAKE-100.PPK

Page 3.03
Event: 100 yr

SCS UNIT HYDROGRAPH METHOD

STORM EVENT: 100 year storm
Duration = 24.0000 hrs Rain Depth = 4.3944 in
Rain Dir = S:\HAESTAD\PPK6\
Rain File -ID = 100-YR.RNF - Tbl 100YR(MAP25)
Unit Hyd Type = Default Curvilinear
HYG Dir = S:\A03068\HYDRO\
HYG File - ID = LAKE-100.HYG - SITE-E 100-POST 100
Tc = .5000 hrs
Drainage Area = 76.700 acres Runoff CN= 95

=====
Computational Time Increment = .06667 hrs
Computed Peak Time = 12.4000 hrs
Computed Peak Flow = 104.36 cfs

Time Increment for HYG File = .0500 hrs
Peak Time, Interpolated Output = 12.4000 hrs
Peak Flow, Interpolated Output = 104.36 cfs
=====

DRAINAGE AREA

ID:None Selected
CN = 95
Area = 76.700 acres
S = .5263 in
0.2S = .1053 in

Cumulative Runoff

3.8203 in
24.418 ac-ft

HYG Volume... 24.418 ac-ft (area under HYG curve)

***** UNIT HYDROGRAPH PARAMETERS *****

Time Concentration, Tc = .50000 hrs (ID: None Selected)
Computational Incr, Tm = .06667 hrs = 0.20000 Tp

Unit Hyd. Shape Factor = 483.432 (37.46% under rising limb)
K = 483.43/645.333, K = .7491 (also, K = 2/(1+(Tr/Tp))
Receding/Rising, Tr/Tp = 1.6698 (solved from K = .7491)

Unit peak, qp = 173.81 cfs
Unit peak time, Tp = .33333 hrs
Unit receding limb, Tr = 1.33333 hrs
Total unit time, Tb = 1.66667 hrs

S/N: HOM0L0102006 Robert A. Karn & Associates, Inc.
Pond Pack Ver: 8-01-98 (61) Compute Time: 10:57:02

Date: 10-11-2004

Type.... SCS Unit Hyd. (HYG output)
 Name.... SITE-E 100-POST Tag: 100
 File.... S:\A03068\HYDRO\LAKE-100.PPK

Page 3.04
 Event: 100 yr

SCS UNIT HYDROGRAPH METHOD

STORM EVENT: 100 year storm
 Duration = 24.0000 hrs Rain Depth = 4.3944 in
 Rain Dir = S:\HAESTAD\PPK6\
 Rain File -ID = 100-YR.RNF - Tbl 100YR(MAP25)
 Unit Hyd Type = Default Curvilinear
 HYG Dir = S:\A03068\HYDRO\
 HYG File - ID = LAKE-100.HYG - SITE-E 100-POST 100
 Tc = .5000 hrs
 Drainage Area = 76.700 acres Runoff CN= 95
 Calc.Increment= .06667 hrs Out.Incr.= .0500 hrs
 HYG Volume = 24.418 ac-ft

HYDROGRAPH ORDINATES (cfs)

Output Time increment = .0500 hrs
 Time on left represents time for first value in each row.

Time hrs					
1.3000	.00	.00	.01	.02	.05
1.5500	.08	.13	.20	.28	.37
1.8000	.47	.58	.70	.81	.93
2.0500	1.04	1.12	1.17	1.18	1.12
2.3000	1.06	.98	.90	.84	.80
2.5500	.78	.77	.78	.80	.82
2.8000	.85	.89	.93	.98	1.03
3.0500	1.08	1.14	1.19	1.26	1.32
3.3000	1.39	1.46	1.53	1.60	1.68
3.5500	1.75	1.83	1.91	2.00	2.09
3.8000	2.18	2.27	2.36	2.46	2.56
4.0500	2.66	2.76	2.86	2.97	3.08
4.3000	3.18	3.30	3.41	3.52	3.64
4.5500	3.76	3.88	4.00	4.13	4.25
4.8000	4.38	4.51	4.64	4.77	4.90
5.0500	5.04	5.17	5.31	5.45	5.59
5.3000	5.73	5.88	6.02	6.17	6.31
5.5500	6.46	6.60	6.75	6.90	7.05
5.8000	7.20	7.35	7.50	7.66	7.81
6.0500	7.97	8.13	8.28	8.44	8.60
6.3000	8.76	8.92	9.07	9.23	9.39
6.5500	9.55	9.71	9.88	10.04	10.20
6.8000	10.36	10.52	10.68	10.84	11.00
7.0500	11.07	11.01	10.79	10.36	9.70
7.3000	8.99	8.29	7.65	7.16	6.82
7.5500	6.60	6.50	6.50	6.56	6.67
7.8000	6.81	6.99	7.20	7.42	7.66
8.0500	7.91	8.18	8.45	8.73	9.02
8.3000	9.31	9.61	9.91	10.21	10.51
8.5500	10.82	11.14	11.45	11.77	12.08
8.8000	12.40	12.72	13.04	13.37	13.69
9.0500	13.83	13.70	13.22	12.30	10.85

Type.... SCS Unit Hyd. (HYG output)
 Name.... SITE-E 100-POST Tag: 100
 File.... S:\A03068\HYDRO\LAKE-100.PPK

Page 3.05
 Event: 100 yr

HYDROGRAPH ORDINATES (cfs)
 Output Time increment = .0500 hrs
 Time on left represents time for first value in each row.

Time hrs					
9.3000	9.28	7.68	6.16	4.90	3.95
9.5500	3.28	2.87	2.77	2.86	3.11
9.8000	3.51	4.10	4.79	5.56	6.38
10.0500	7.28	8.21	9.17	10.16	11.20
10.3000	12.23	13.29	14.35	15.43	16.52
10.5500	17.63	18.75	19.88	21.01	22.14
10.8000	23.28	24.42	25.58	26.75	27.91
11.0500	28.76	29.17	29.01	28.15	26.63
11.3000	25.16	23.95	23.20	23.36	24.18
11.5500	25.44	26.92	27.88	28.54	29.15
11.8000	29.94	32.03	35.05	38.84	43.23
12.0500	49.24	56.84	66.15	77.31	88.75
12.3000	97.57	103.02	104.36	100.57	94.44
12.5500	86.80	78.50	71.48	65.80	61.19
12.8000	57.38	54.01	50.65	47.25	43.77
13.0500	40.39	37.46	35.18	33.77	33.46
13.3000	33.56	33.91	34.37	34.70	34.73
13.5500	34.49	34.01	33.32	32.56	31.72
13.8000	30.83	29.87	28.85	27.81	26.74
14.0500	25.64	24.52	23.39	22.25	21.08
14.3000	19.92	18.75	17.58	16.41	15.23
14.5500	14.04	12.84	11.65	10.46	9.28
14.8000	8.10	6.95	5.84	4.80	3.85
15.0500	3.13	2.63	2.37	2.42	2.97
15.3000	3.85	5.03	6.49	8.09	9.58
15.5500	10.94	12.10	12.92	13.53	13.94
15.8000	14.20	14.29	14.30	14.24	14.13
16.0500	13.96	13.76	13.54	13.29	13.02
16.3000	12.74	12.45	12.15	11.84	11.52
16.5500	11.20	10.87	10.54	10.21	9.88
16.8000	9.55	9.21	8.87	8.54	8.20
17.0500	7.98	7.93	8.09	8.52	9.27
17.3000	10.08	10.92	11.72	12.38	12.89
17.5500	13.26	13.52	13.68	13.78	13.84
17.8000	13.85	13.83	13.79	13.73	13.65
18.0500	13.56	13.46	13.35	13.24	13.12
18.3000	13.00	12.88	12.75	12.63	12.50
18.5500	12.37	12.23	12.10	11.97	11.84
18.8000	11.71	11.57	11.44	11.30	11.16
19.0500	11.03	10.90	10.76	10.63	10.50
19.3000	10.36	10.23	10.09	9.96	9.82
19.5500	9.69	9.55	9.42	9.28	9.15
19.8000	9.02	8.89	8.76	8.62	8.49
20.0500	8.36	8.22	8.09	7.95	7.81
20.3000	7.68	7.54	7.41	7.27	7.14
20.5500	7.00	6.87	6.73	6.60	6.46
20.8000	6.33	6.19	6.06	5.92	5.79

Type.... SCS Unit Hyd. (HYG output)
 Name.... SITE-E 100-POST Tag: 100
 File.... S:\A03068\HYDRO\LAKE-100.PPK

Page 3.06
 Event: 100 yr

HYDROGRAPH ORDINATES (cfs)
 Output Time increment = .0500 hrs
 Time on left represents time for first value in each row.

Time hrs					
21.0500	5.65	5.52	5.39	5.26	5.12
21.3000	4.99	4.86	4.72	4.59	4.45
21.5500	4.32	4.18	4.05	3.91	3.78
21.8000	3.65	3.51	3.38	3.24	3.11
22.0500	3.05	3.09	3.26	3.61	4.15
22.3000	4.74	5.33	5.89	6.35	6.72
22.5500	6.99	7.18	7.30	7.39	7.45
22.8000	7.48	7.48	7.47	7.44	7.41
23.0500	7.37	7.32	7.27	7.22	7.16
23.3000	7.10	7.03	6.96	6.90	6.83
23.5500	6.76	6.69	6.62	6.55	6.48
23.8000	6.41	6.34	6.27	6.20	6.12
24.0500	5.99	5.78	5.45	4.97	4.34
24.3000	3.68	3.03	2.41	1.89	1.48
24.5500	1.14	.89	.70	.55	.43
24.8000	.33	.26	.20	.16	.12
25.0500	.09	.07	.05	.04	.03
25.3000	.02	.02	.01	.01	.00
25.5500	.00	.00			

SITE-III

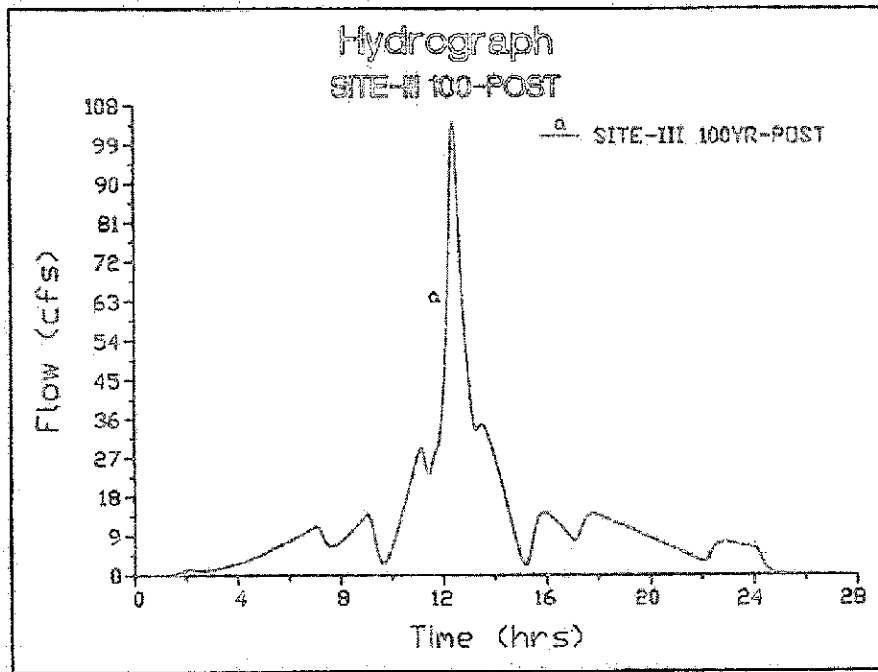
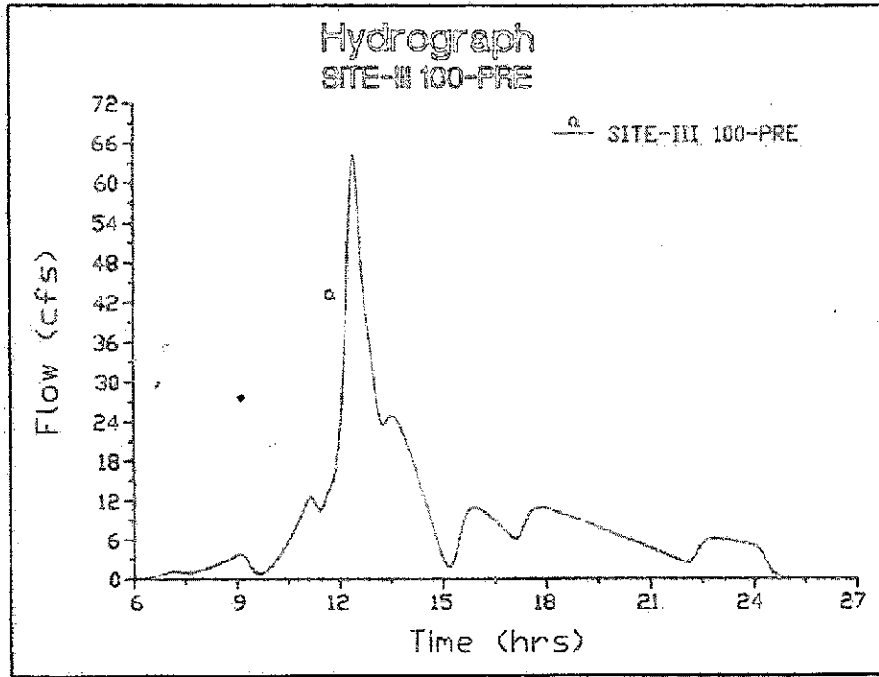

STORAGE ESTIMATE

Type.... Vol.Est: Overlay Est.
Name.... VOL.SITE-III

Page 2.01

File.... S:\A03068\HYDRO\LAKE-100.PPK
Title... PRE DEVELOPED vs DEVELOPED

DETENTION STORAGE ESTIMATE (Estimated by overlaying hydrographs)

INFLOW HYDROGRAPH...
HYG file = LAKE-100.HYG
HYG ID = SITE-E 100-POST
HYG Tag = 100

OVERLAY HYDROGRAPH...
HYG file = LAKE-100.HYG
HYG ID = SITE-E 100-PRE
HYG Tag = 100

Estimate Type	Est.Storage ac-ft	From hrs	To hrs
Overlay HYG	10.318	1.3000	25.6000

APPENDIX B

**Preliminary Grading Plan and
Storm Drain Storage Plans**

ALL INFORMATION CONTAINED HEREIN IS UNCLASSIFIED
DATE 08/20/2013 BY 60322 UCBAW/SJS/STP

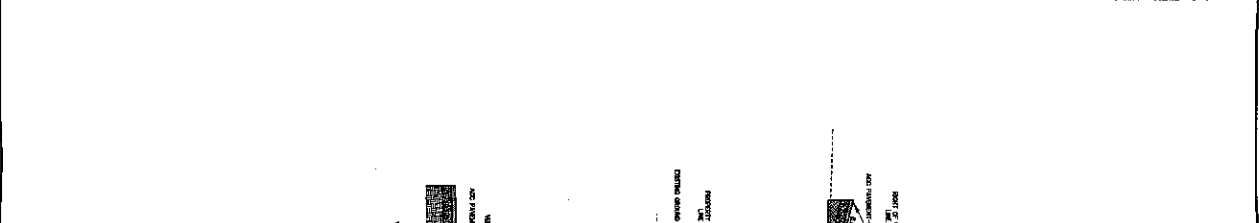
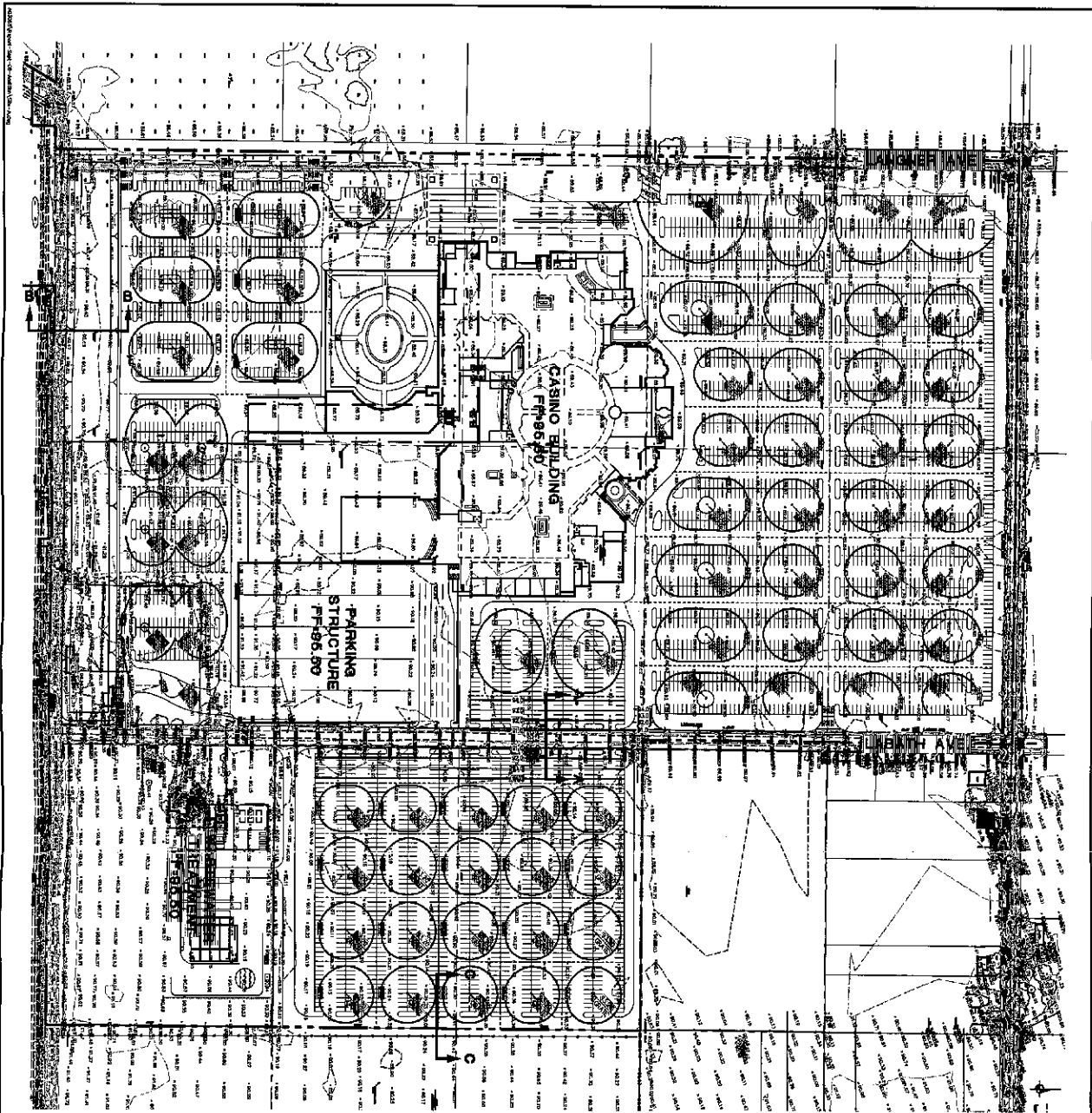

LEGEND

- PROPOSED MAJOR CONTOUR
- PROPOSED MINOR CONTOUR
- GRADE BUSH
- GRADE ELEVATION
- ROCK LINE
- EXISTING SPOT ELEVATION

GRAPHIC SCALE
 300'
 1" = 300'

PRELIMINARY SUBJECT TO REVISION

NO.	DATE	BY	CHK	REV	DESCRIPTION
1					

**PRELIMINARY GRADING PLAN (LAYOUT A)
 FEDERATED INDIANS OF GRATON RANCHERIA
 SONOMA COUNTY, CALIFORNIA**

RAK ROBERT A. KARN & ASSOCIATES, INC.
 CIVIL ENGINEERS
 707 BECK AVENUE
 FAIRFIELD, CALIFORNIA 94533
 Phone: (707) 435-3954 Fax: (707) 435-9969
 e-mail: rak@rakengr.com

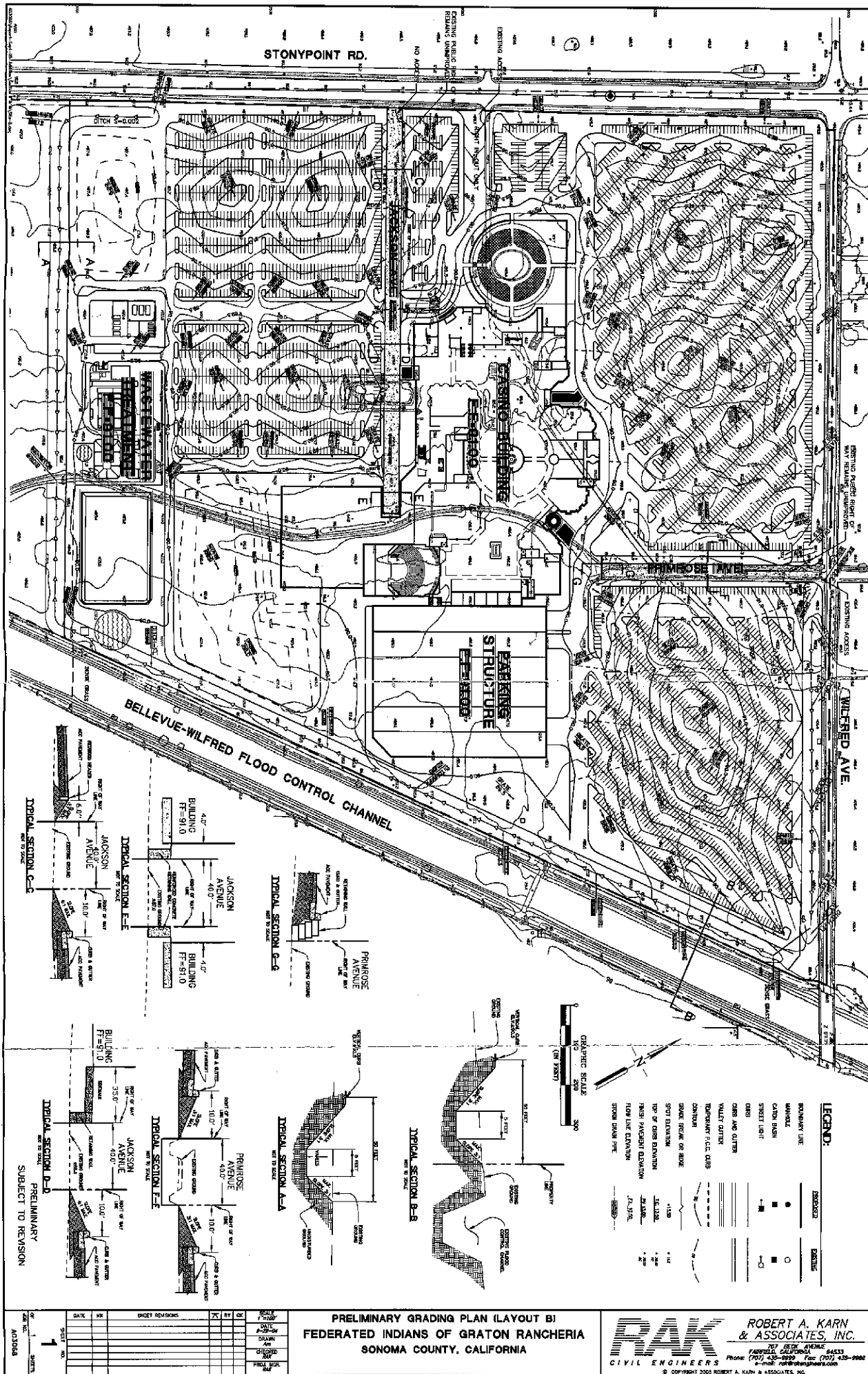

**PRELIMINARY GRADING PLAN (LAYOUT B)
 FEDERATED INDIANS OF GRATON RANCHERIA
 SONOMA COUNTY, CALIFORNIA**

RAK
 CIVIL ENGINEERS

**ROBERT A. KARN
 & ASSOCIATES, INC.**
 707 REDWOOD AVENUE SUITE 3033
 FARMERSVILLE, CALIFORNIA 94933
 Phone: (707) 435-1929 Fax: (707) 435-9968
 e-mail: rak@rakengr.com

NO.	DATE	BY	CHK	REV	DESCRIPTION
1					
2					
3					
4					
5					
6					
7					
8					
9					
10					

DATE: 10/15/03
 DRAWN BY: [Signature]
 CHECKED BY: [Signature]
 PROJECT NO.: 03-001
 SHEET NO.: 1
 TOTAL SHEETS: 1

PRELIMINARY
 SUBJECT TO REVISION

© COPYRIGHT 2003 ROBERT A. KARN & ASSOCIATES, INC.

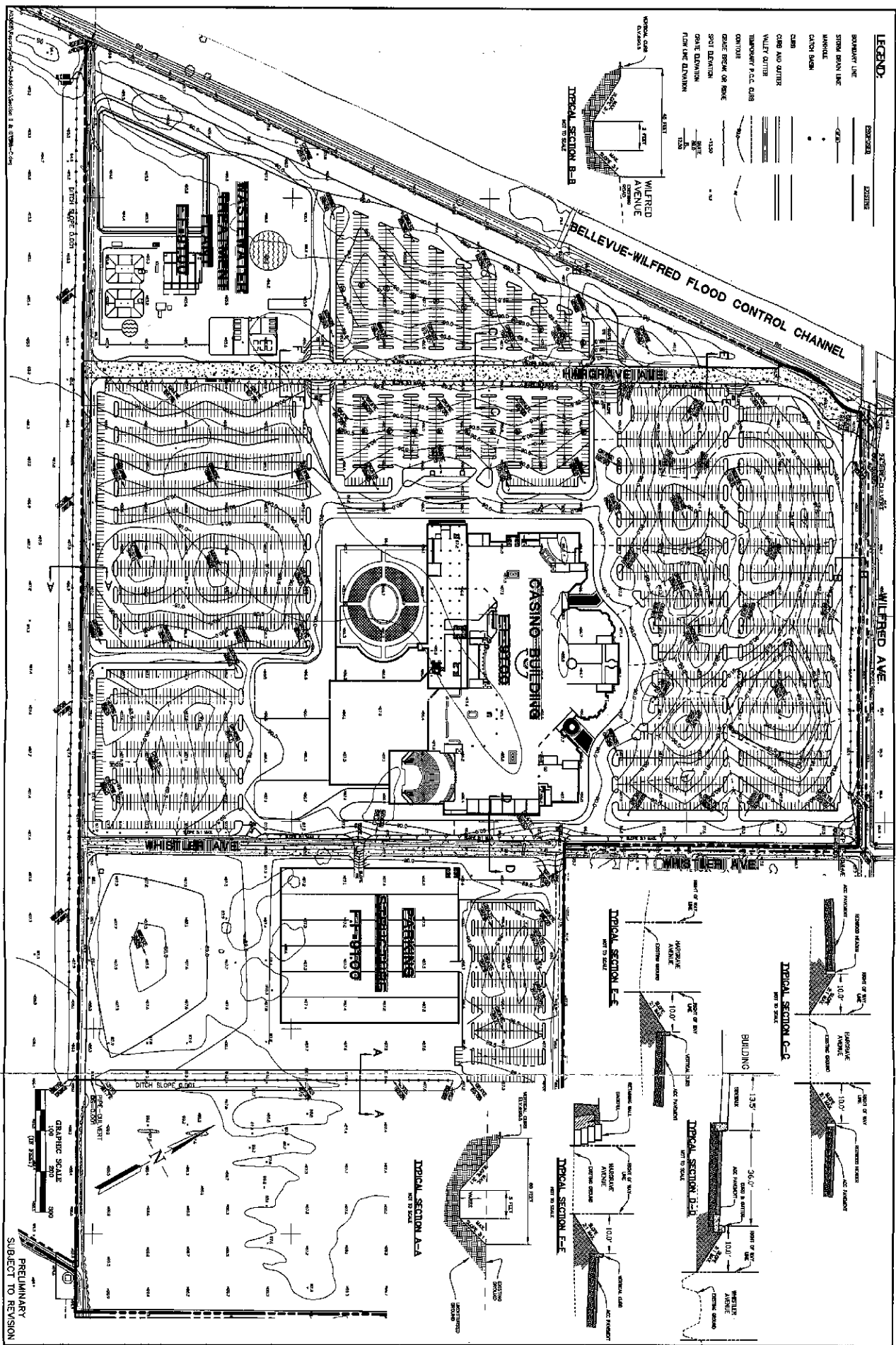

LEGEND:

- BOUNDARY LINE
- STREET BOUNDARY LINE
- MANHOLE
- CATCH BASIN
- CLUB
- CLUB AND OUTLET
- VALLEY CENTER
- TEMPORARY P.C.C. CLUB
- CONTOUR
- GRADE BEAM OR BOX
- SOFT ELEVATION
- SOFT ELEVATION
- FLOW LINE DIVISION

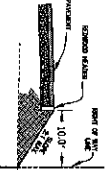
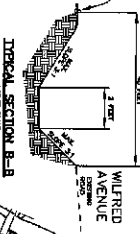

BUILDING

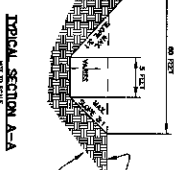
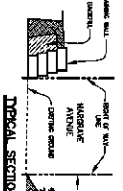
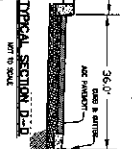

DATE	BY	CHK	REV	DESCRIPTION

SCALE: 1" = 20'

GRAPHIC SCALE: 0' 10' 20' 30'

PRELIMINARY SUBJECT TO REVISION

PRELIMINARY GRADING PLAN (LAYOUT C)
FEDERATED INDIANS OF GRATON RANCHERIA
 SONOMA COUNTY, CALIFORNIA

RAK CIVIL ENGINEERS

ROBERT A. KARN & ASSOCIATES, INC.

207 BUCK AVENUE
 FAIRFAX, CALIFORNIA 94933
 Phone: (707) 433-3398 Fax: (707) 433-0088
 e-mail: rak@rakengr.com

© COPYRIGHT 2005 ROBERT A. KARN & ASSOCIATES, INC.

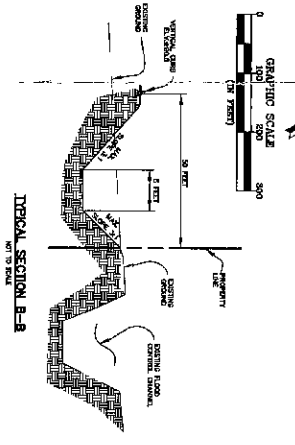
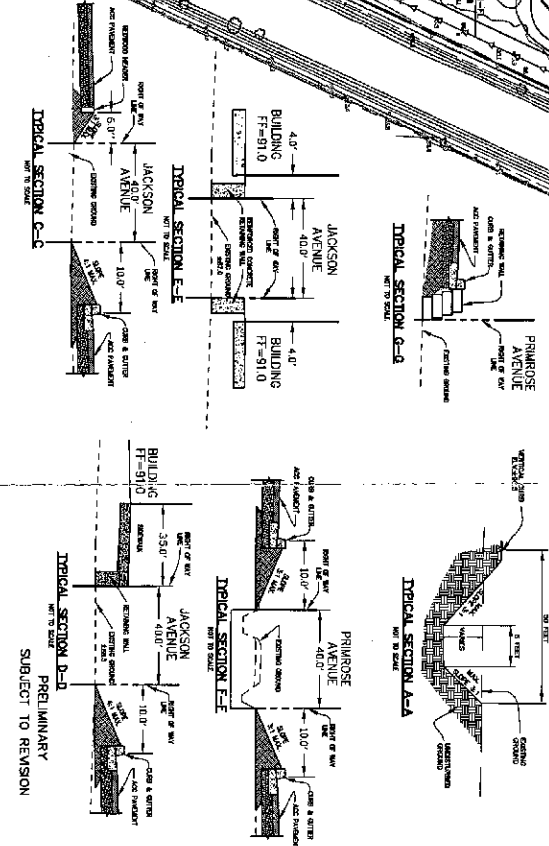
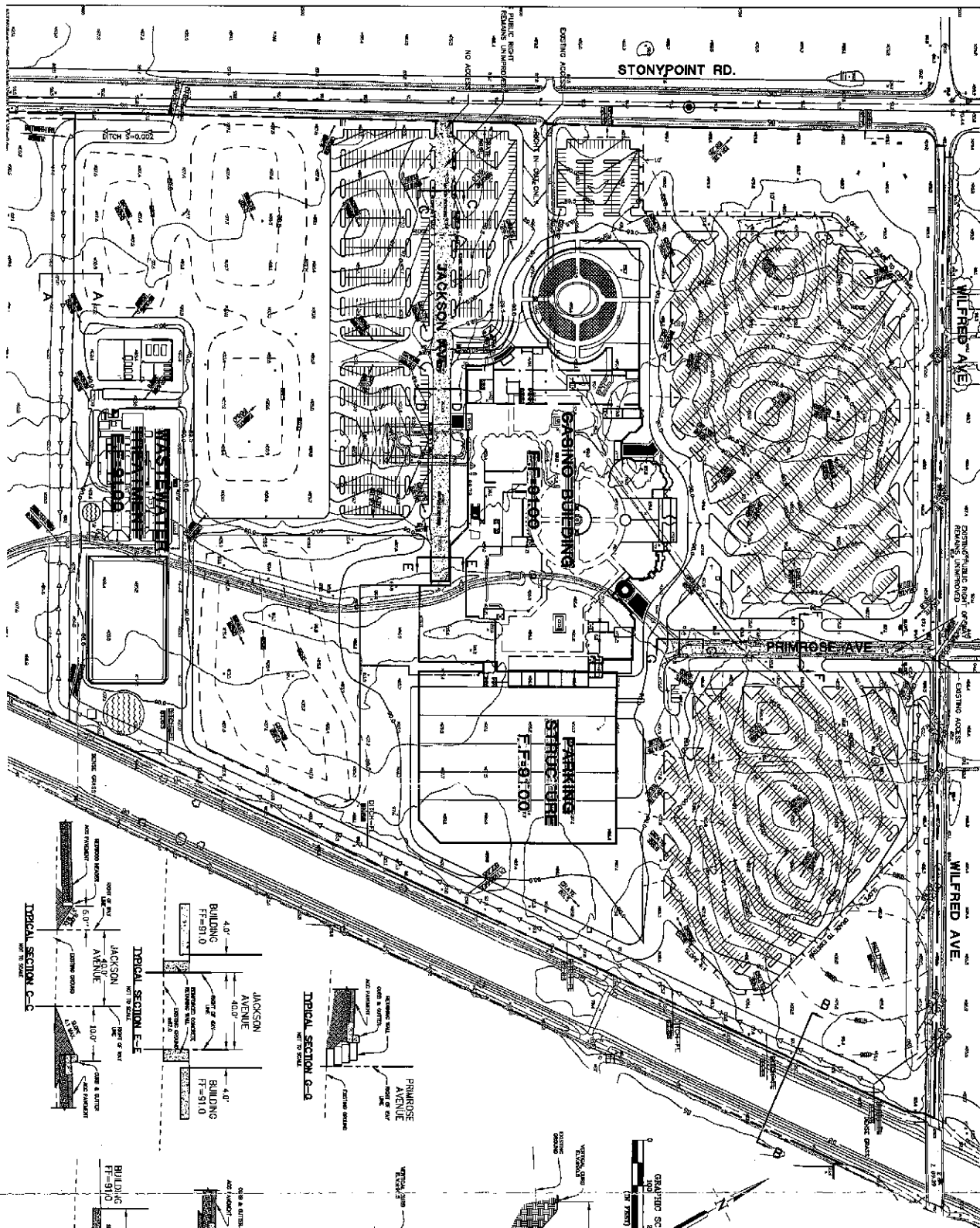

LEGEND

PROPOSED	EXISTING
BOUNDARY LINE	
MANHOLE	
CATCH BASIN	
STREET LIGHT	
CURB	
DESK AND UTILITY	
VAULTS	
TEMPORARY P.C.C. CURB	
CONCRETE	
SOILS BREAK OR FENCE	
SPOT ELEVATION	
TOP OF CURB ELEVATION	
FINISH PAVEMENT ELEVATION	
FINISH CURB ELEVATION	
STORM SEWER PIPE	

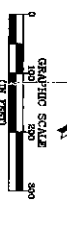

GRADING SCALE
 0 100 200 300
 FEET
 (SEE SHEET)

DATE	BY	REVISIONS

PRELIMINARY GRADING PLAN (LAYOUT D)
FEDERATED INDIANS OF GRATON RANCHERIA
BONOMA COUNTY, CALIFORNIA

RAK ROBERT A. KARN & ASSOCIATES, INC.
 CIVIL ENGINEERS
 707 BEEK AVENUE, SUITE 100, BONONA, CALIFORNIA 94009
 Phone: (707) 435-9999 Fax: (707) 435-9998
 e-mail: rak@rakengr.com
 © COPYRIGHT 2005 ROBERT A. KARN & ASSOCIATES, INC.

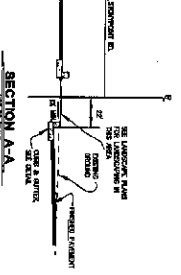
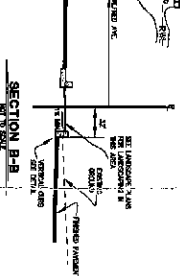
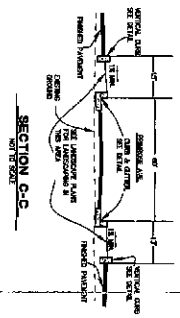
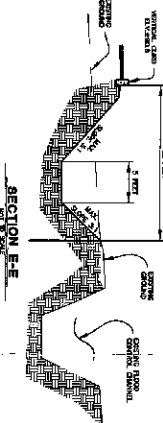
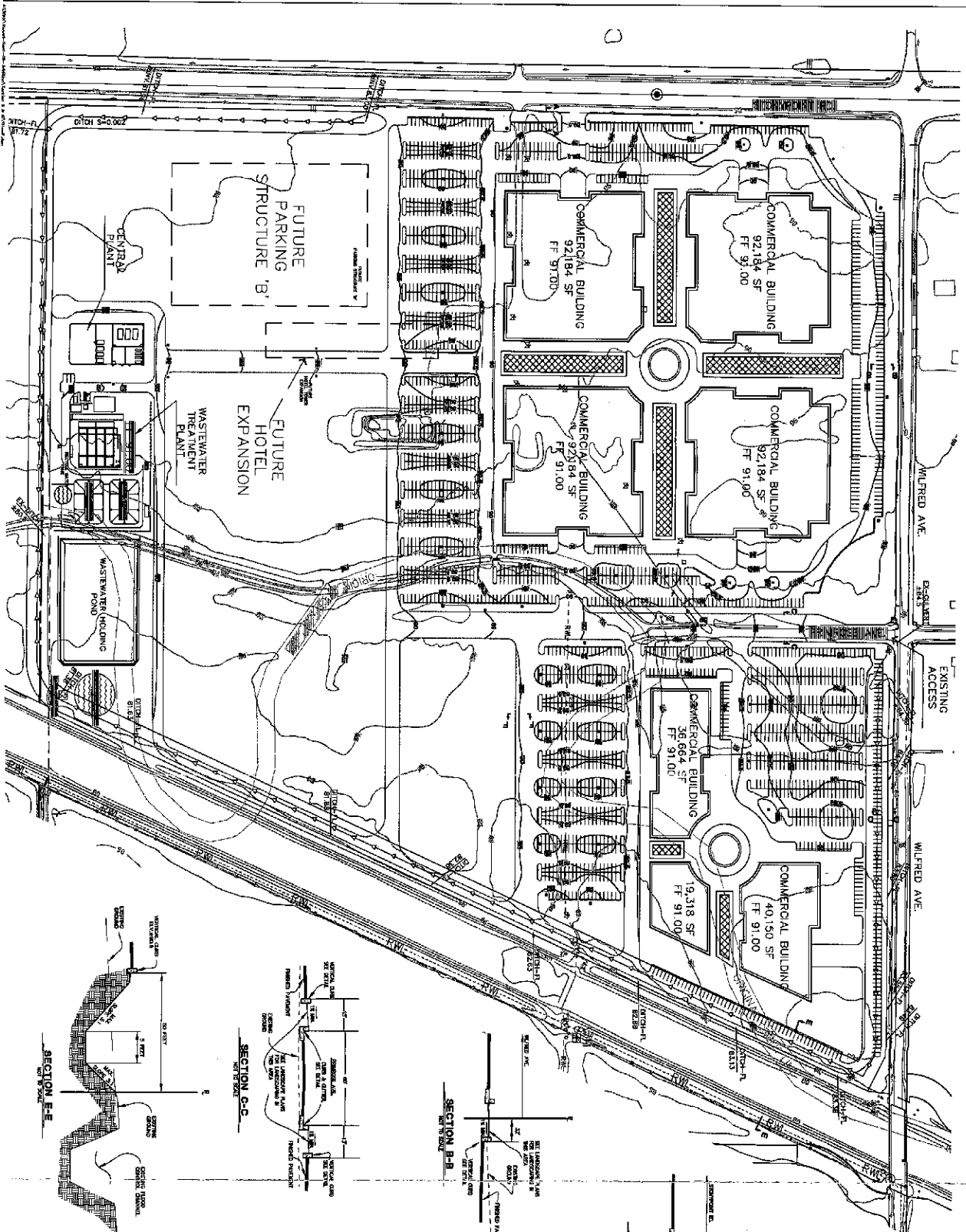

- LEGEND**
- CLUB AND OFFICE
 - VALLEY DRIVES
 - TEMPORARY P.C. DRIVE
 - CONDUIT
 - GRADE BREAK ON ROAD
 - SPOT ELEVATION
 - TOP OF CURB ELEVATION
 - FRESH PAVEMENT ELEVATION
 - FROM LINE ELEVATION
 - STEEL DOWN PIPE
 - CLUB
 - JACK SIGN
 - STOP SIGN
 - FL. SIGN

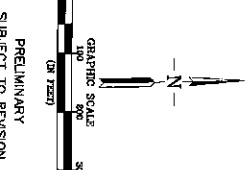

NO.	DATE	BY	REVISIONS
1			

**PRELIMINARY GRADING PLAN (LAYOUT E)
FEDERATED INDIANS OF GRATON RANCHERIA
SONOMA COUNTY, CALIFORNIA**

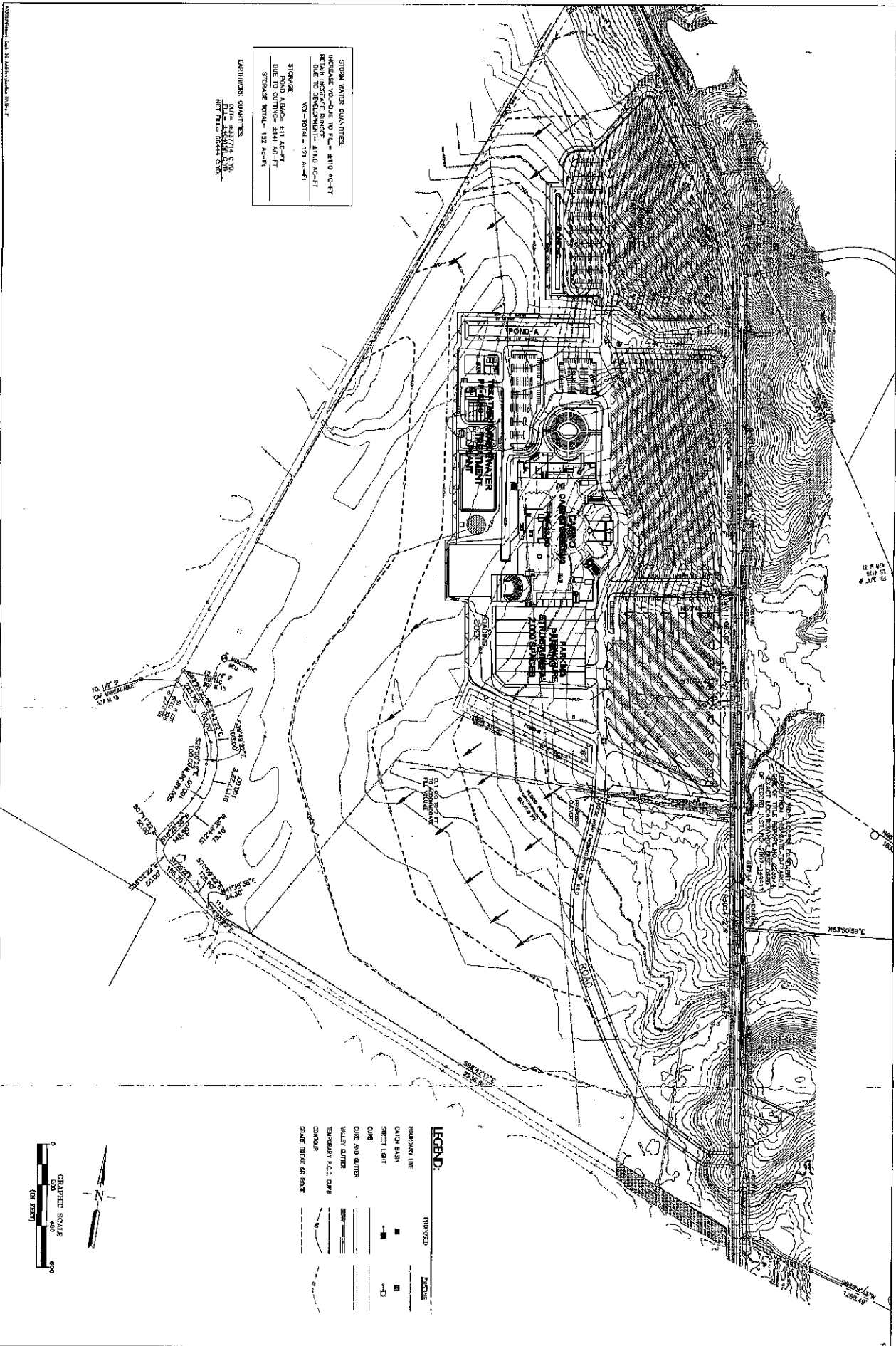

ROBERT A. KARN & ASSOCIATES, INC.
 707 BECK AVENUE, SUITE 100
 FAIRFIELD, CALIFORNIA 94504
 Phone: (707) 432-3399 Fax: (707) 432-0988
 e-mail: rak@rakassociates.com
© COPYRIGHT 2003 ROBERT A. KARN & ASSOCIATES, INC.



STORAGE WATER QUANTITIES:
 INCREASE 70% DUE TO P.L.S. = 4110 AC-FT
 DUE TO DECORATION = 4110 AC-FT
 TOTAL = 8220 AC-FT

STORAGE:
 VOL. TOTAL = 123 AC-FT
 POND AREA = 411 AC-FT
 DUE TO CUTTING = 411 AC-FT
 STORAGE TOTAL = 122 AC-FT

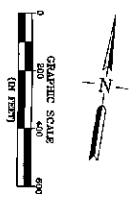
LANDMARK QUANTITIES:
 P.L.S. = 4110 AC-FT
 DECORATION = 4110 AC-FT
 NET TOTAL = 8220 AC-FT



LEGEND:

	EMBEDDED	SCHEMATIC
BOUNDARY LINE	—	—
CANYON BASH	—	—
SMITH LIGHT	—	—
GRID	—	—
GRID AND OTHER	—	—
VALLEY CUTTER	—	—
TEMPORARY P.C.C. CURB	—	—
CONCRETE	—	—
GRADE BEAK OR ROOF	—	—

DATE	BY	REVISIONS

**PRELIMINARY GRADING PLAN (LAYOUT F)
 FEDERATED INDIANS OF GRATON RANCHERIA
 SONOMA COUNTY, CALIFORNIA**

RAK ROBERT A. KARN & ASSOCIATES, INC.
 CIVIL ENGINEERS
 707 BECK AVENUE
 SAN FRANCISCO, CALIFORNIA 94105
 Phone: (415) 435-9774 Fax: (415) 435-9958
 e-mail: rak@raakassociates.com
 © COPYRIGHT 2005 ROBERT A. KARN & ASSOCIATES, INC.

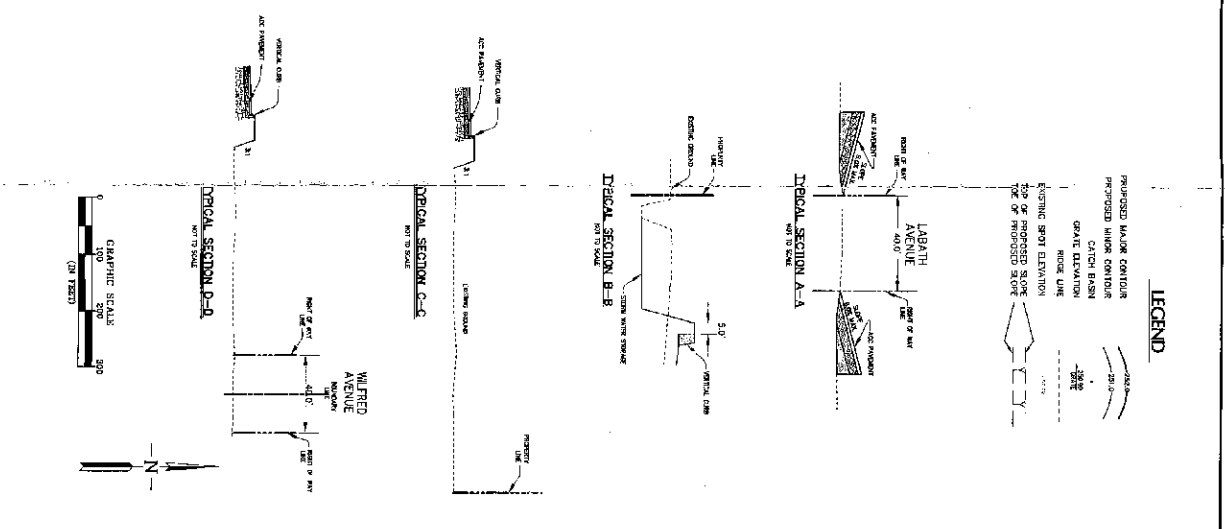
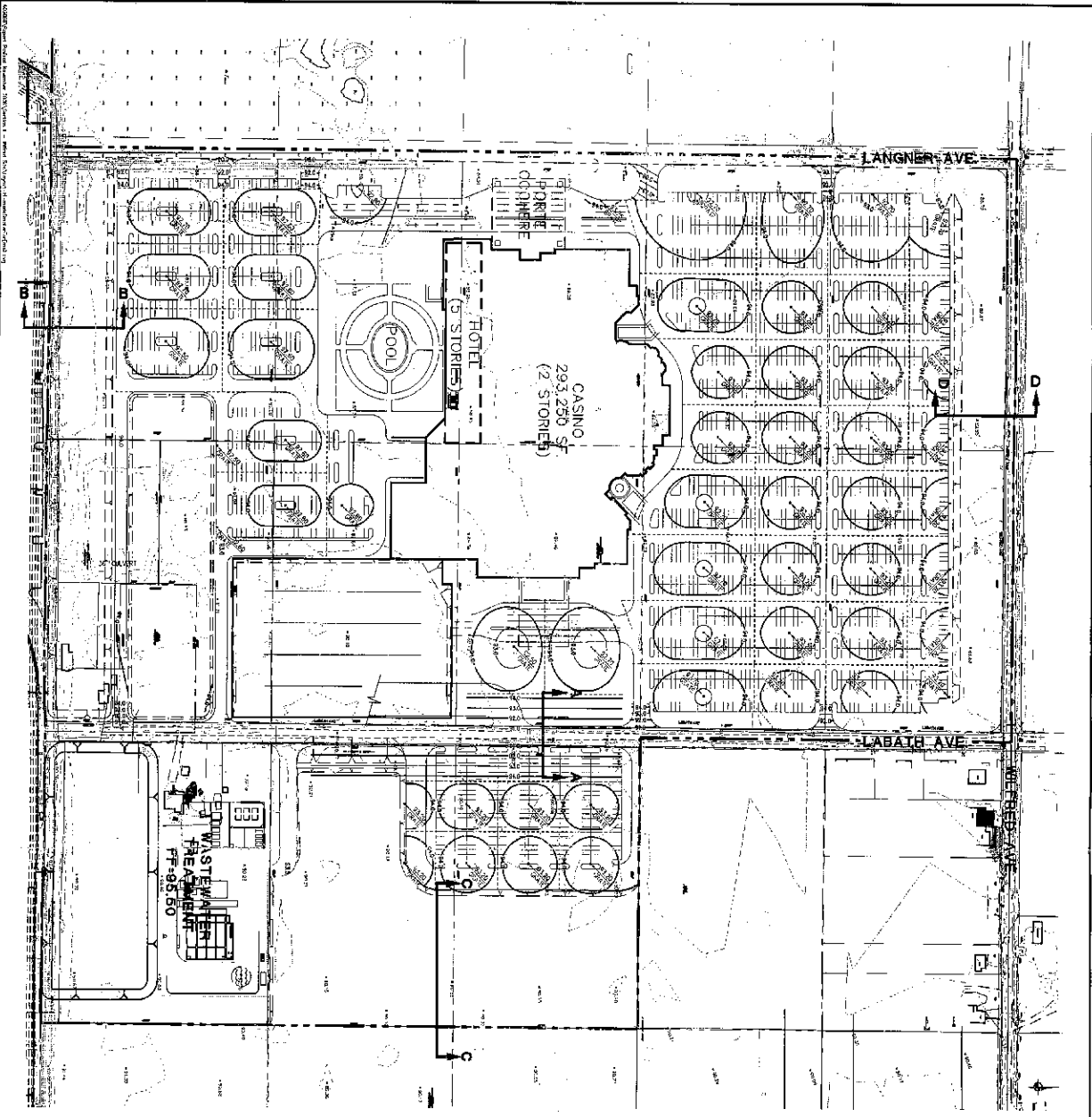

GRAPHIC SCALE
1" = 20' (SEE 12503)

DATE: _____
BY: _____
CHECKED: _____
SCALE: 1" = 20'

REVISIONS

NO.	DATE	BY	DESCRIPTION

PRELIMINARY GRADING PLAN (LAYOUT H)
FEDERATED INDIANS OF GRATON RANCHERIA
SONOMA COUNTY, CALIFORNIA

RAK ROBERT A. KARN & ASSOCIATES, INC.
 CIVIL ENGINEERS
 707 BELLEVUE AVENUE SUITE 21555
 FARMERSVILLE, CALIFORNIA 94535
 PHONE (707) 436-8865 FAX (707) 435-8860
 WWW.RAKENGINEERS.COM

LEGEND

- PROPOSED MAJOR CONTOUR
- PROPOSED MINOR CONTOUR
- EXISTING MAJOR CONTOUR
- EXISTING MINOR CONTOUR
- GRADE ELEVATION
- PROPOSED ELEVATION
- EXISTING ELEVATION
- SCOUR SLOT ELEVATION
- TOP OF PROPOSED SLOPE
- TOP OF EXISTING SLOPE

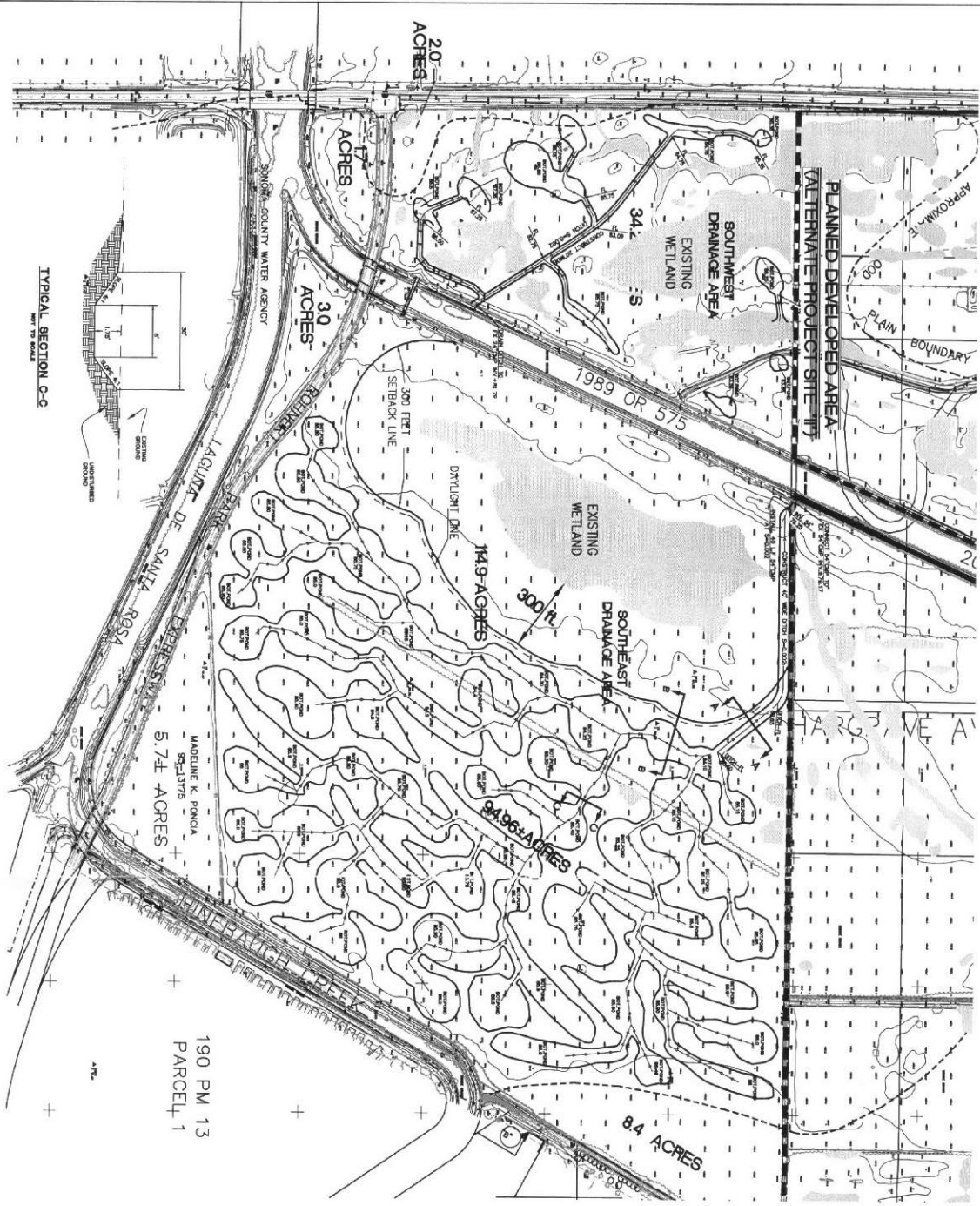

TYPICAL SECTION C-C
NOT TO SCALE

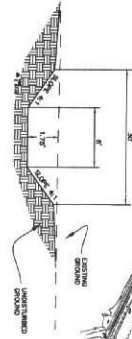

190 PM 13
PARCEL 1

LAYOUTS B, D, AND E STORM DRAIN STORAGE

- SOUTHEAST DRAINAGE
POND DEPTH = ±1.75 Feet
- SOUTHWEST DRAINAGE
POND DEPTH = ±3.25 Feet
- EXISTING WETLANDS

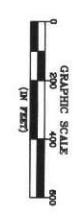

TYPICAL SECTION B-B
NOT TO SCALE

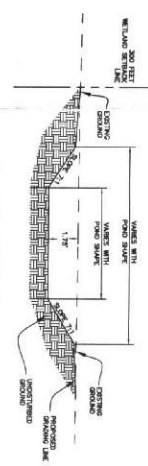

TYPICAL SECTION A-A
NOT TO SCALE

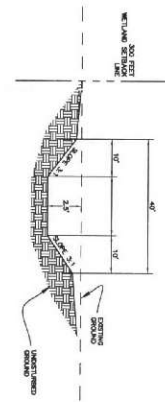

PRELIMINARY
SUBJECT TO REVISION

DATE	BY	CHK	REVISIONS

FEDERATED INDIANS OF GRATON RANCHERIA
SONOMA COUNTY, CALIFORNIA

RAK
CIVIL ENGINEERS

ROBERT A. KARN & ASSOCIATES, INC.
707 BECK AVENUE
FAIRFIELD, CALIFORNIA 94533
Phone: (707) 435-9599 Fax: (707) 435-9988
e-mail: rak@rakengeers.com

© COPYRIGHT 2009 ROBERT A. KARN & ASSOCIATES, INC.

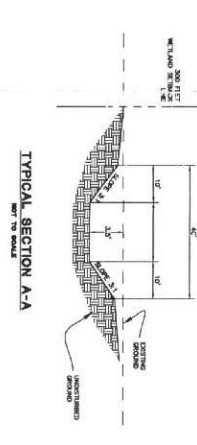
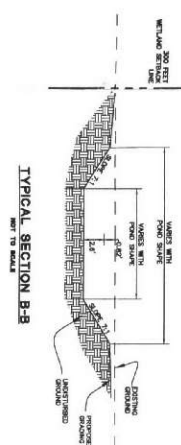
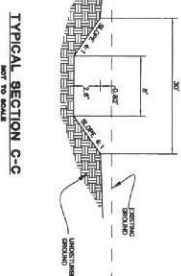
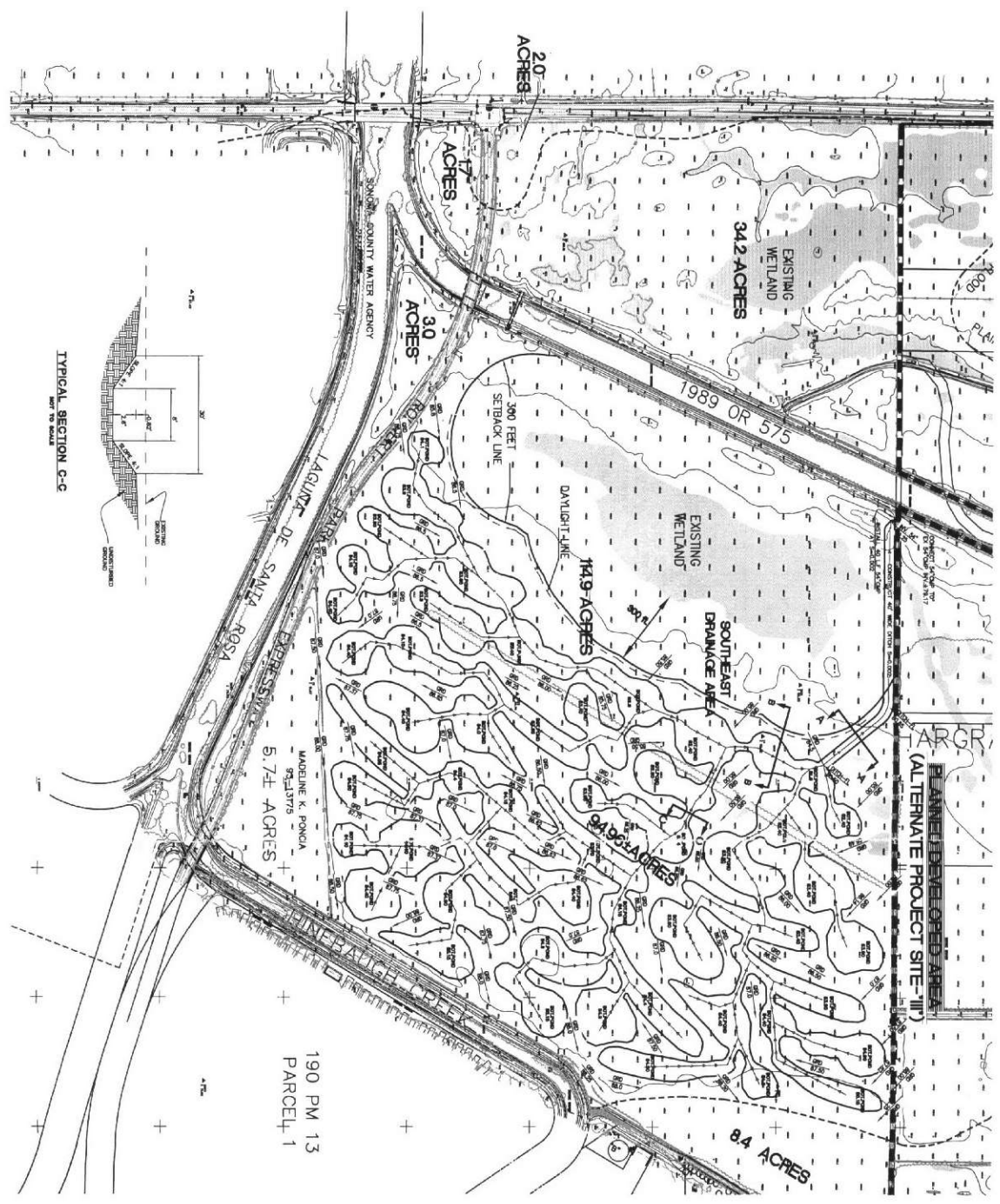

LAYOUT C
STORM DRAIN STORAGE
 SOUTHEAST DRAINAGE
 POND DEPTH = ±2.8 Feet

EXISTING WETLANDS

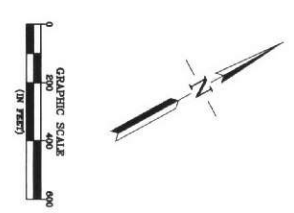

DATE	BY	CHK	SCALE
10/1/05	AK	AK	1"=200'
10/1/05	AK	AK	1"=200'
10/1/05	AK	AK	1"=200'
10/1/05	AK	AK	1"=200'
10/1/05	AK	AK	1"=200'
10/1/05	AK	AK	1"=200'
10/1/05	AK	AK	1"=200'
10/1/05	AK	AK	1"=200'
10/1/05	AK	AK	1"=200'
10/1/05	AK	AK	1"=200'

FEDERATED INDIANS OF GRATON RANCHERIA
 SONOMA COUNTY, CALIFORNIA

RAK
 CIVIL ENGINEERS

ROBERT A. KARN & ASSOCIATES, INC.
 707 BECK AVENUE
 FAIRFIELD, CALIFORNIA 94533
 Phone (707) 435-8999 Fax (707) 435-8988
 e-mail: rak@rakengineers.com

© COPYRIGHT 2005 ROBERT A. KARN & ASSOCIATES, INC.

PRELIMINARY
 SUBJECT TO REVISION

APPENDIX C

Existing Storm Drain Culverts

PRELIMINARY SUBJECT TO REVIEW

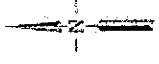
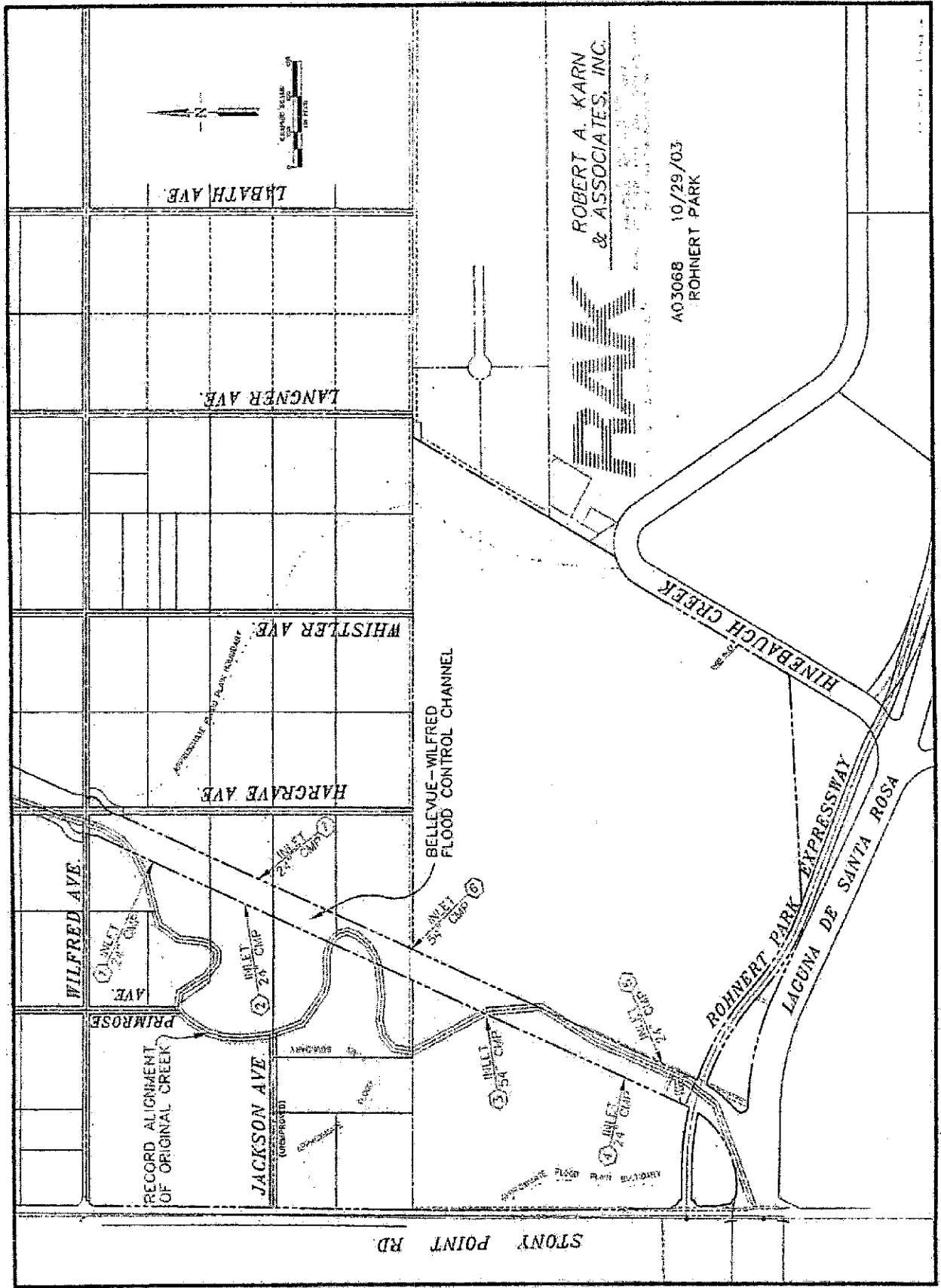

LABATH AVE.

LANGNER AVE.

WHISTLER AVE.

HARGRAVE AVE.

WILFRED AVE.

PRIMROSE AVE.

JACKSON AVE.
(UNIMPROVED)

BELLEVUE-WILFRED
FLOOD CONTROL CHANNEL

RECORD ALIGNMENT
OF ORIGINAL CREEK

STONY POINT RD.

ROBERT A. KARN
& ASSOCIATES, INC.

PARK

A03068 10/29/03
ROHNERT PARK

HINEBAUCH CREEK

ROHNERT PARK EXPRESSWAY

LAGUNA DE SANTA ROSA

INLET 24' CMP

INLET 24' CMP

INLET 54' CMP

INLET 54' CMP

INLET 54' CMP

INLET 24' CMP

APPROXIMATE FLOOD RAIN BOUNDARY

**Drainage Structure #1
24" Corrugated Metal Pipe with Sandbags**

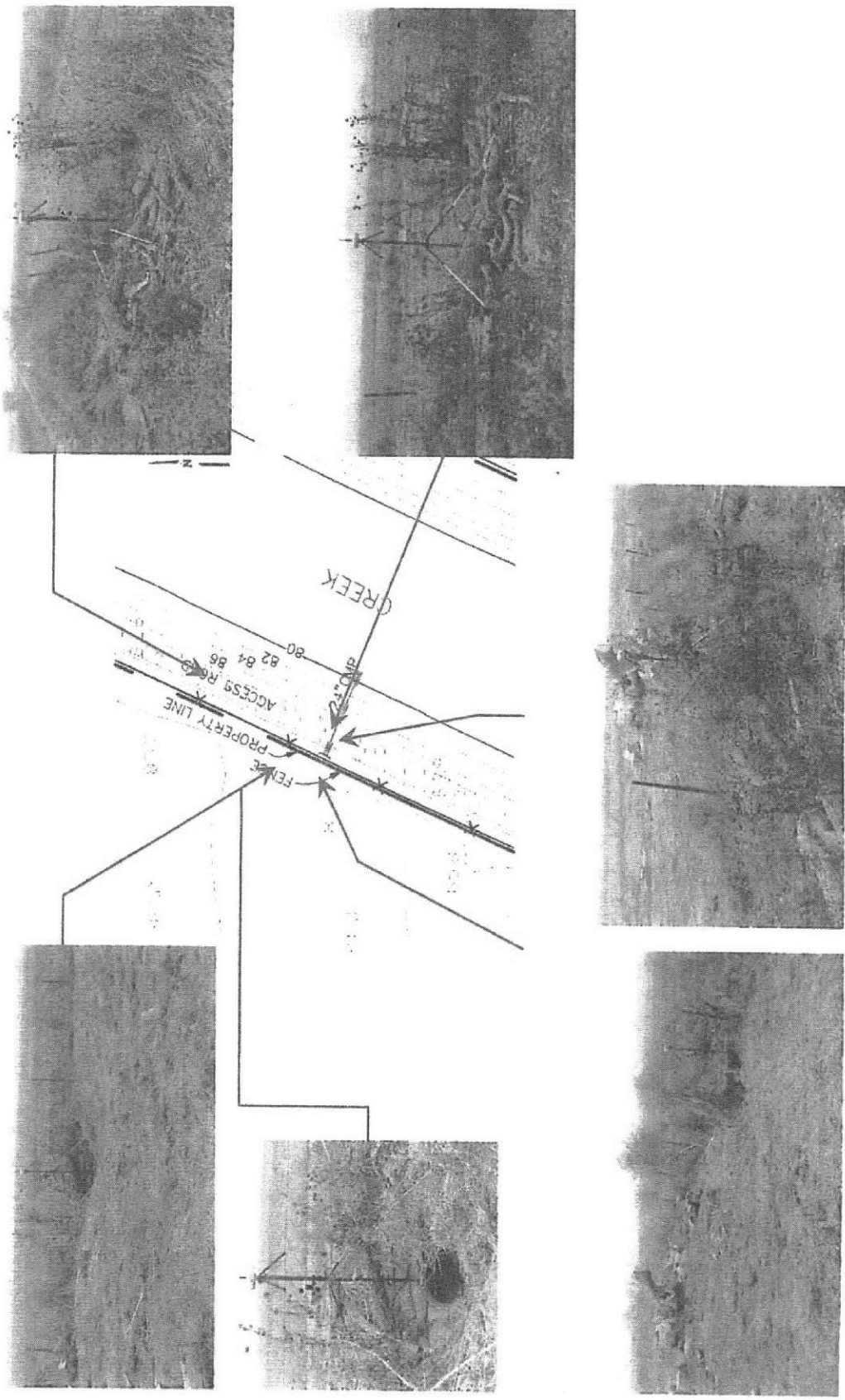

Drainage Structure #2
24" Corrugated Metal Pipe with Sandbags

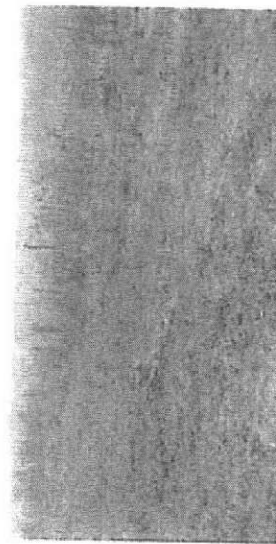
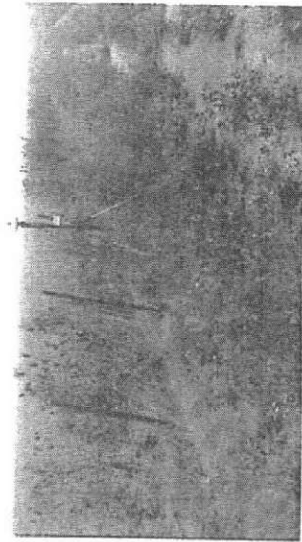
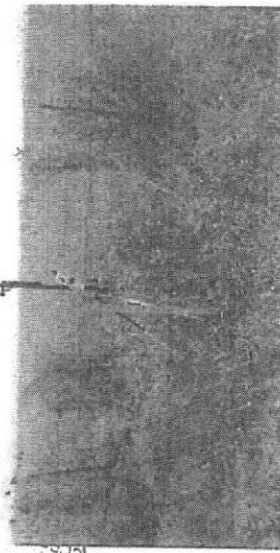
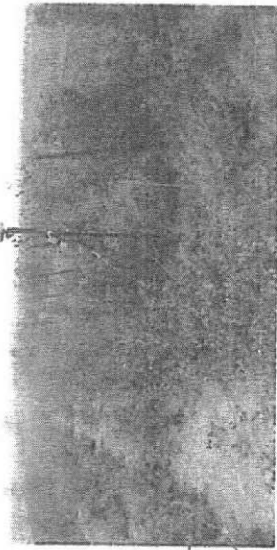
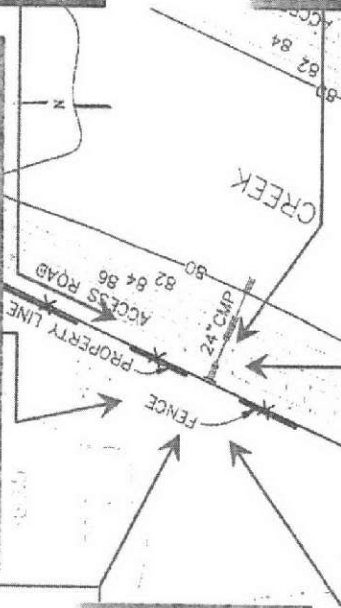
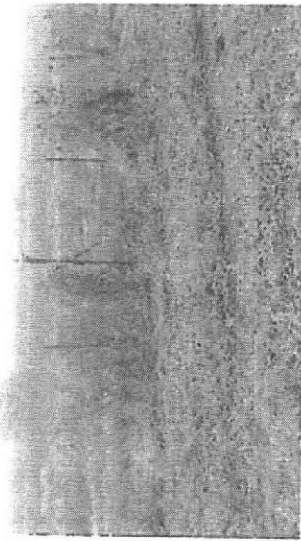
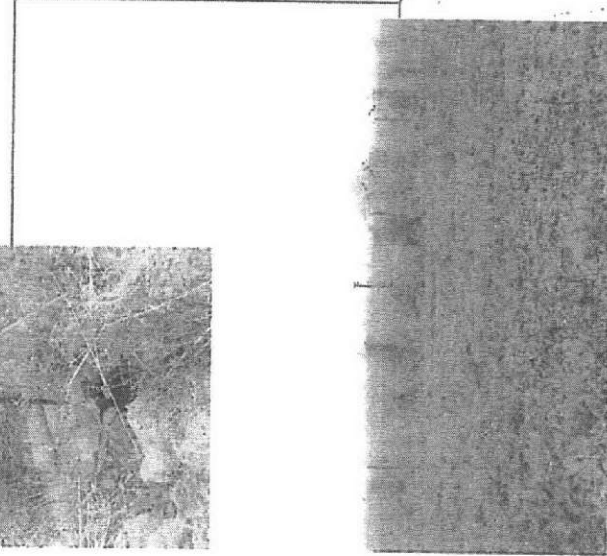
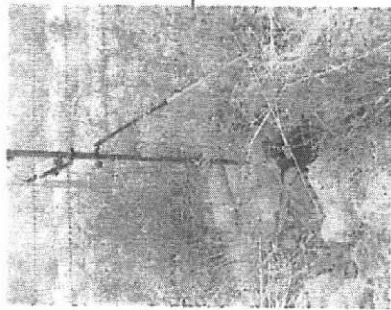

Drainage Structure #3
54" Corrugated Metal Pipe with Sandbags

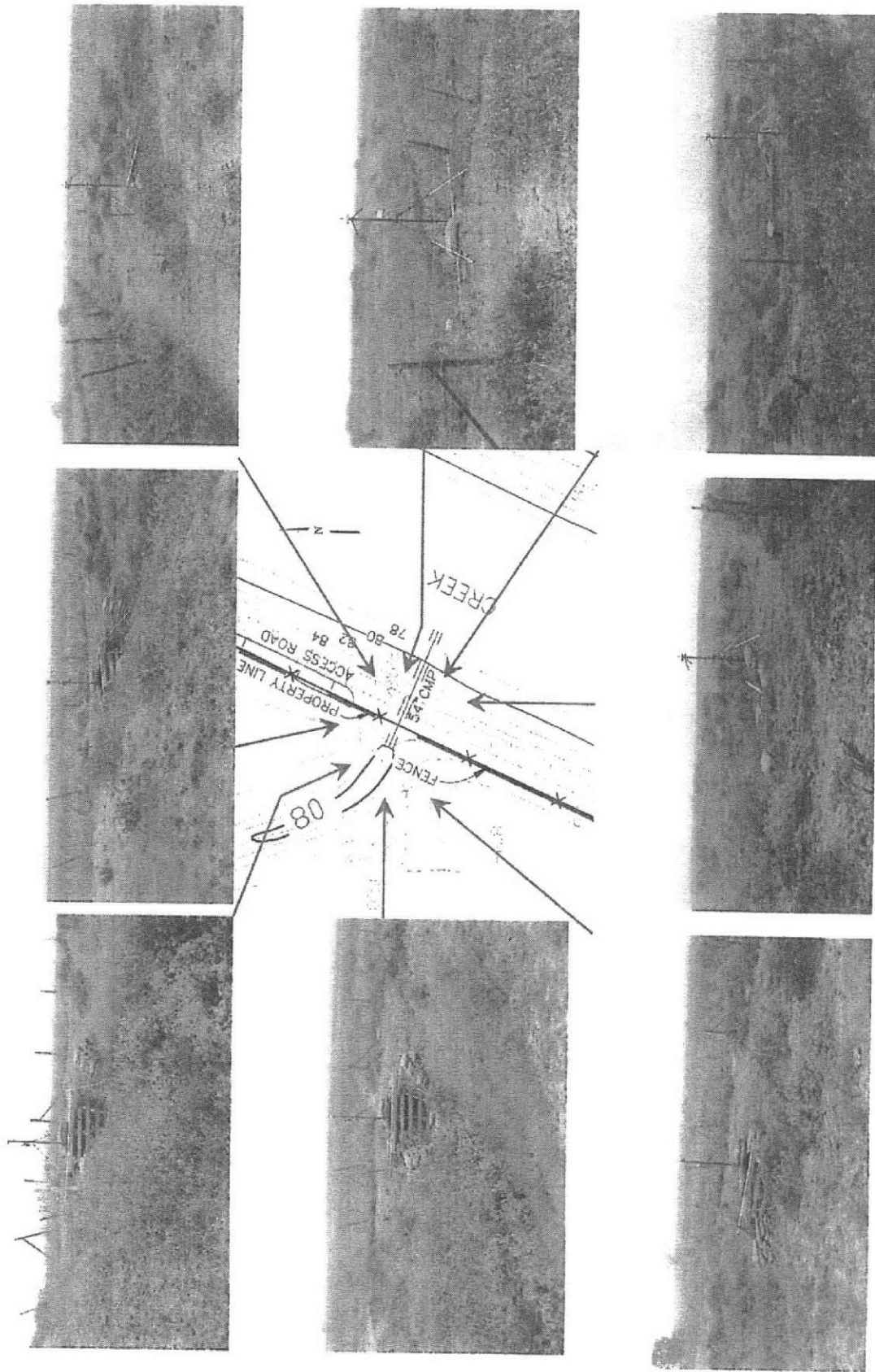

Drainage Structure #4
24" Corrugated Metal Pipe with Sandbags

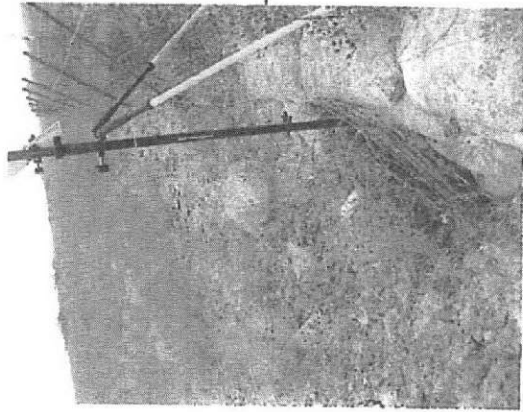
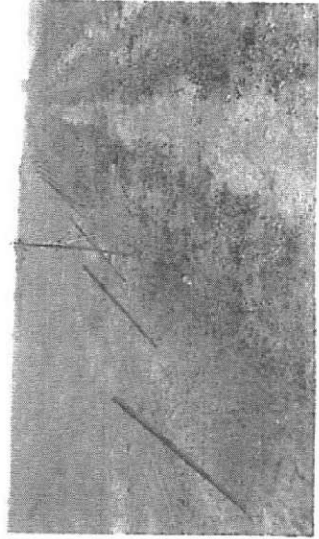
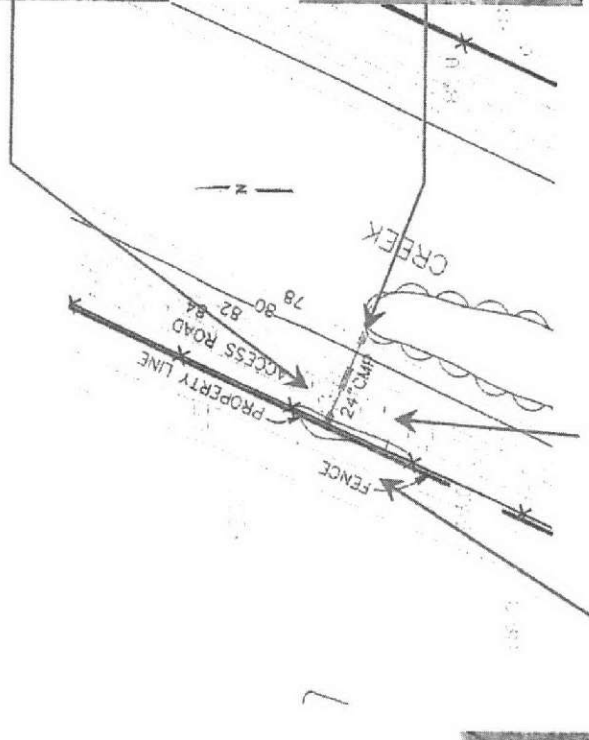
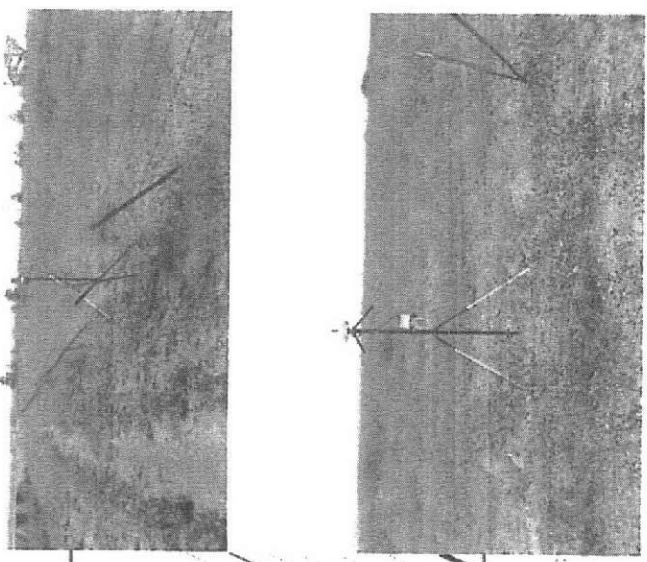

Drainage Structure #5
24" Corrugated Metal Pipe with Sandbags & Metal Grate

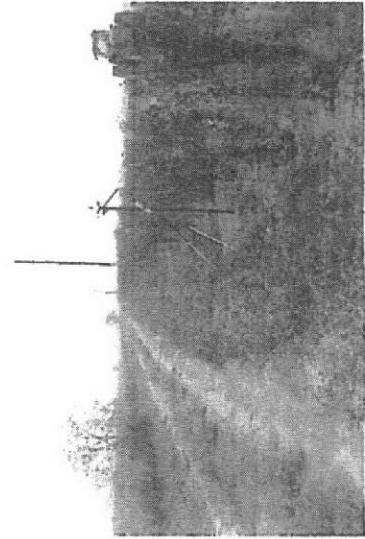
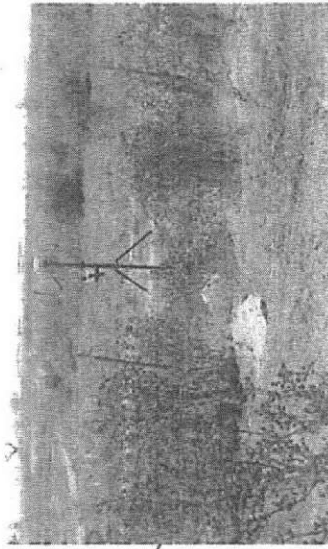
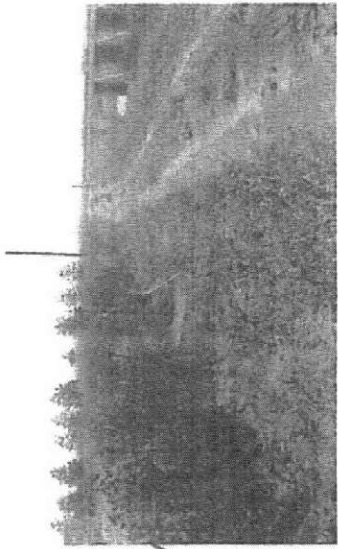
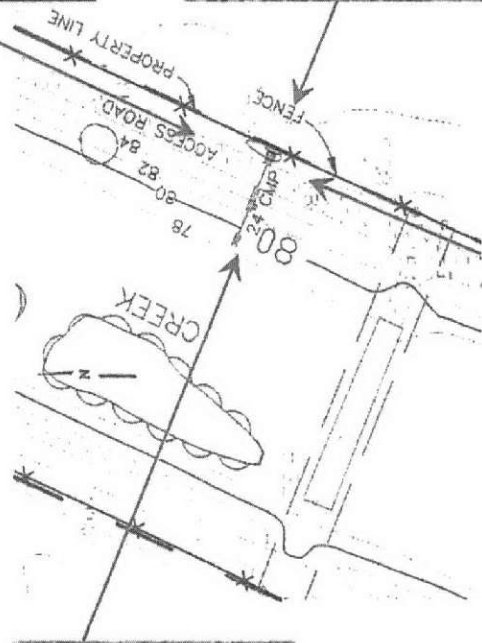
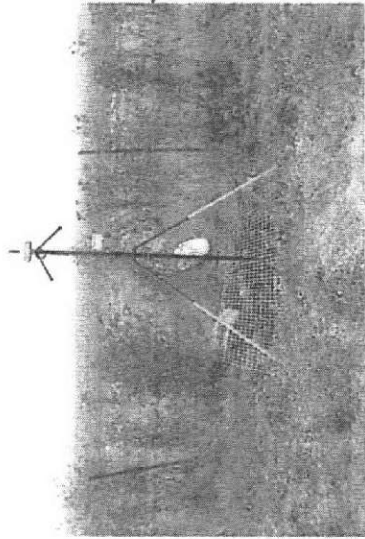

Drainage Structure #6
54" Corrugated Metal Pipe with Sandbags

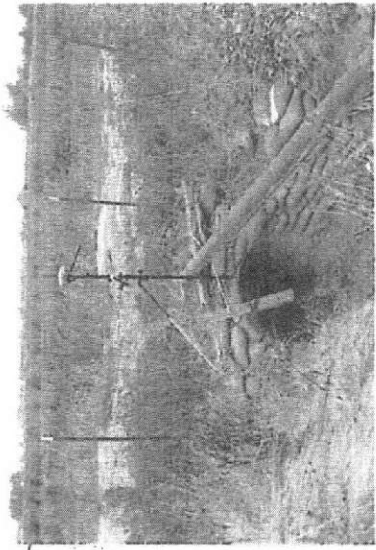
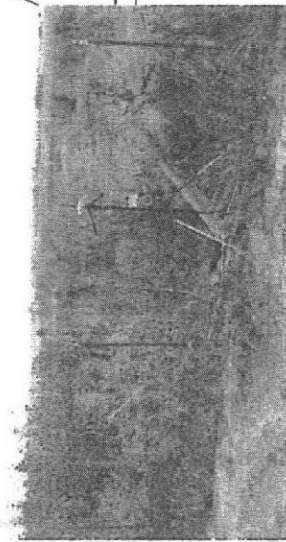
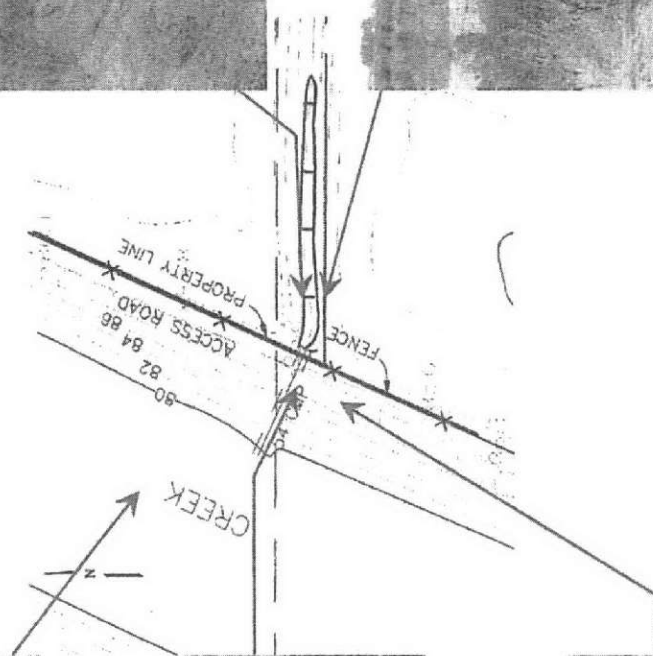
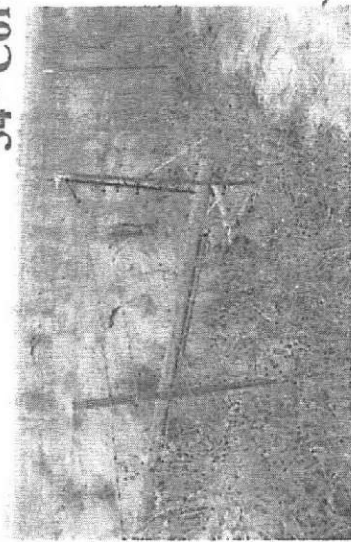

Drainage Structure #7
24" Corrugated Metal Pipe with Sandbags & Metal Grate

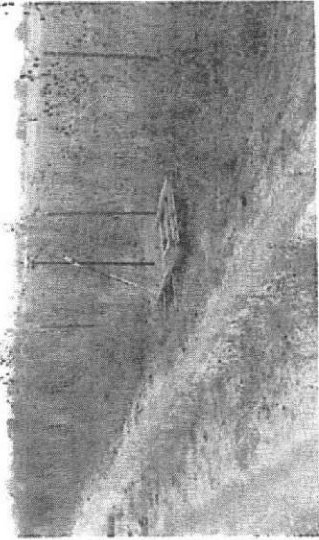
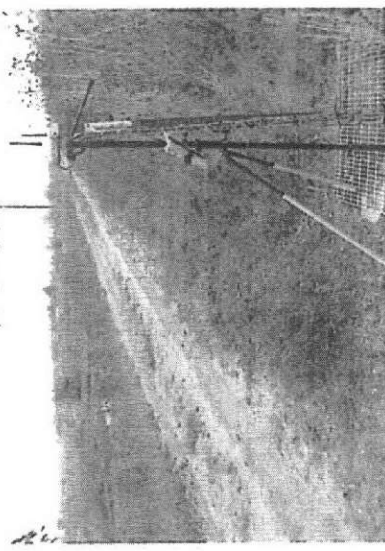
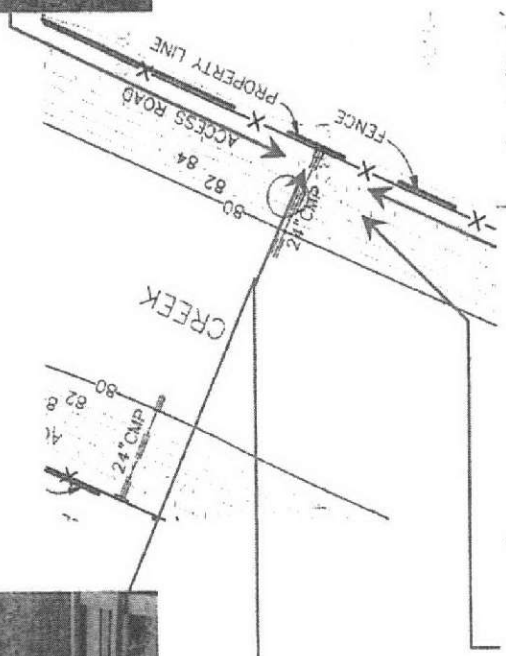
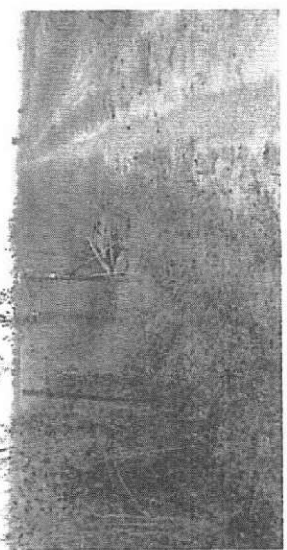
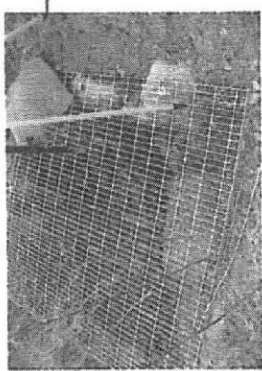
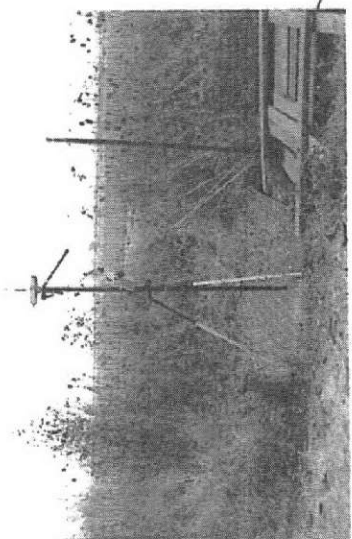

APPENDIX D

Sample Best Management Practices

PRELIMINARY SUBJECT TO REVIEW

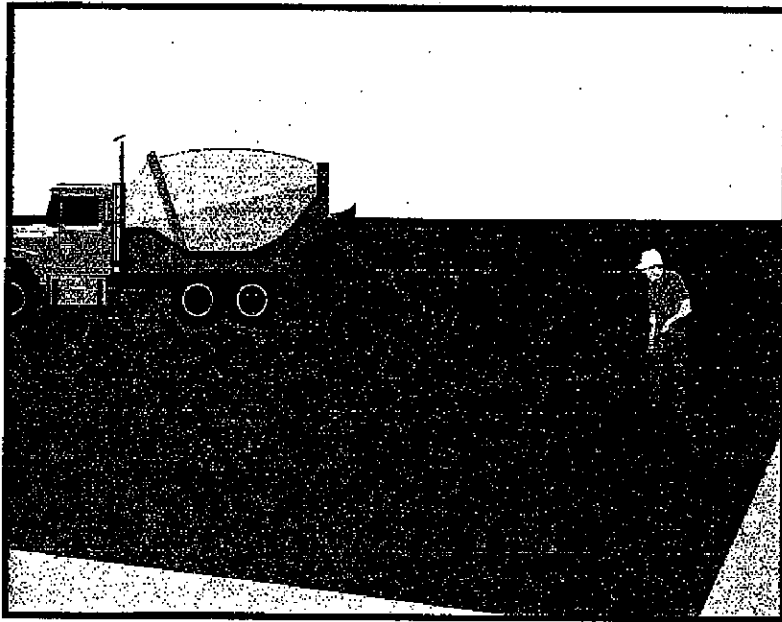

Description and Purpose

Prevent or reduce the discharge of pollutants from paving operations, using measures to prevent runoff and runoff pollution, properly disposing of wastes, and training employees and subcontractors.

Suitable Applications

These procedures are implemented where paving, surfacing, resurfacing, or sawcutting, may pollute stormwater runoff or discharge to the storm drain system or watercourses.

Limitations

- Finer solids are not effectively removed by filtration systems.
- Paving opportunities may be limited during wet weather.

Implementation

General

- Avoid paving during the wet season when feasible.
- Reschedule paving and grinding activities if rain is in the forecast.
- Train employees and sub-contractors in pollution prevention and reduction.
- Store materials away from drainage courses to prevent stormwater runoff (see WM-1, Material Delivery and Storage).

Objectives

EC	Erosion Control	
SE	Sediment Control	
TC	Tracking Control	
WE	Wind Erosion Control	
NS	Non-Stormwater Management Control	✓
WM	Waste Management and Materials Pollution Control	✓

Legend:

- ✓ Primary Objective
- ✓ Secondary Objective

Targeted Constituents

Sediment	✓
Nutrients	
Trash	
Metals	
Bacteria	
Oil and Grease	✓
Organics	

Potential Alternatives

None



NS-3 Paving and Grinding Operations

- Protect drainage courses, particularly in areas with a grade, by employing BMPs to divert runoff or to trap and filter sediment.
- If paving involves an onsite mixing plant, follow the stormwater permitting requirements for industrial activities.
- Stockpile material removed from roadways away from drain inlets, drainage ditches, and watercourses. These materials should be stored consistent with WM-3, Stockpile Management.
- Disposal of PCC and AC waste should be in conformance with WM-8, Concrete Waste Management.

Saw Cutting, Grinding, and Pavement Removal

- Shovel or vacuum saw-cut slurry and remove from site. Cover or barricade storm drains during saw cutting to contain slurry.
- When paving involves AC, the following steps should be implemented to prevent the discharge of grinding residue, uncompacted or loose AC, tack coats, equipment cleaners, or unrelated paving materials:
 - AC grindings, pieces, or chunks used in embankments or shoulder backing must not be allowed to enter any storm drains or watercourses. Install silt fence until structure is stabilized or permanent controls are in place. Examples of temporary perimeter controls can be found in EC-9, Earth Dikes and Drainage Swales; SE-1, Silt Fence; or SE-5, Fiber Rolls.
 - Collect and remove all broken asphalt and recycle when practical. Old or spilled asphalt must be recycled or disposed.
 - Any AC chunks and pieces used in embankments must be placed above the water table and covered by at least 1 ft of material.
- Do not allow saw-cut slurry to enter storm drains or watercourses. Residue from grinding operations should be picked up by means of a vacuum attachment to the grinding machine, should not be allowed to flow across the pavement, and should not be left on the surface of the pavement. See also WM-8, Concrete Waste Management, and WM-10, Liquid Waste Management.
- Dig out activities should not be conducted in the rain.
- Collect dig out material by mechanical or manual methods. This material may be recycled for use as shoulder backing or base material.
- If dig out material cannot be recycled, transport the material back to an approved storage site.

Asphaltic Concrete Paving

- If paving involves asphaltic cement concrete, follow these steps:

- Do not allow sand or gravel placed over new asphalt to wash into storm drains, streets, or creeks. Vacuum or sweep loose sand and gravel and properly dispose of this waste by referring to WM-5, Solid Waste Management.
- Old asphalt must be disposed of properly. Collect and remove all broken asphalt from the site and recycle whenever possible.

Portland Cement Concrete Paving

- Do not wash sweepings from exposed aggregate concrete into a storm drain system. Collect and return to aggregate base stockpile or dispose of properly.
- Allow aggregate rinse to settle. Then, either allow rinse water to dry in a temporary pit as described in WM-8, Concrete Waste Management, or pump the water to the sanitary sewer if allowed by the local wastewater authority.

Sealing Operations

- During chip seal application and sweeping operations, petroleum or petroleum covered aggregate must not be allowed to enter any storm drain or water courses. Apply temporary perimeter controls until structure is stabilized.
- Drainage inlet structures and manholes should be covered with filter fabric during application of seal coat, tack coat, slurry seal, and fog seal.
- Seal coat, tack coat, slurry seal, or fog seal should not be applied if rainfall is predicted to occur during the application or curing period.

Paving Equipment

- Leaks and spills from paving equipment can contain toxic levels of heavy metals and oil and grease. Place drip pans or absorbent materials under paving equipment when not in use. Clean up spills with absorbent materials rather than burying. See NS-10, Vehicle and Equipment Maintenance, WM-4, Spill Prevention and Control, and WM-10, Liquid Waste Management.
- Substances used to coat asphalt transport trucks, and asphalt spreading equipment should not contain soap and should be non-foaming and non-toxic.
- Use only non-toxic substances to coat asphalt transport trucks and asphalt spreading equipment.
- Paving equipment parked onsite should be parked over plastic to prevent soil contamination.
- Clean asphalt coated equipment offsite whenever possible. When cleaning dry, hardened asphalt from equipment, manage hardened asphalt debris as described in WM-5, Solid Waste Management. Any cleaning onsite should follow NS-8, Vehicle and Equipment Cleaning.

NS-3 Paving and Grinding Operations

Thermoplastic Striping

- Thermoplastic striper and pre-heater equipment shutoff valves should be inspected to ensure that they are working properly to prevent leaking thermoplastic from entering drain inlets, the stormwater drainage system, or watercourses.
- Pre-heaters should be filled carefully to prevent splashing or spilling of hot thermoplastic. Leave six inches of space at the top of the pre-heater container when filling thermoplastic to allow room for material to move when the vehicle is deadheaded.
- Do not pre-heat, transfer, or load thermoplastic near drain inlets or watercourses.
- Clean truck beds daily of loose debris and melted thermoplastic. When possible, recycle thermoplastic material.

Raised/Recessed Pavement Marker Application and Removal

- Do not transfer or load bituminous material near drain inlets, the stormwater drainage system, or watercourses.
- Melting tanks should be loaded with care and not filled to beyond six inches from the top to leave room for splashing when vehicle is deadheaded.
- When servicing or filling melting tanks, ensure all pressure is released before removing lids to avoid spills.
- On large-scale projects, use mechanical or manual methods to collect excess bituminous material from the roadway after removal of markers.

Costs

- All of the above are low cost measures.

Inspection and Maintenance

- Inspect and verify that activity-based BMPs are in place prior to the commencement of associated activities. While activities associated with the BMP are under way, inspect weekly during the rainy season and at two-week intervals in the non-rainy season to verify continued BMP implementation.
- Keep ample supplies of drip pans or absorbent materials onsite.
- Inspect and maintain machinery regularly to minimize leaks and drips.

References

Blueprint for a Clean Bay: Best Management Practices to Prevent Stormwater Pollution from Construction Related Activities; Santa Clara Valley Nonpoint Source Pollution Control Program, 1995.

Hot Mix Asphalt-Paving Handbook AC 150/5370-14, Appendix I, U.S. Army Corps of Engineers, July 1991.

Stormwater Quality Handbooks - Construction Site Best Management Practices (BMPs) Manual, State of California Department of Transportation (Caltrans), November 2000.

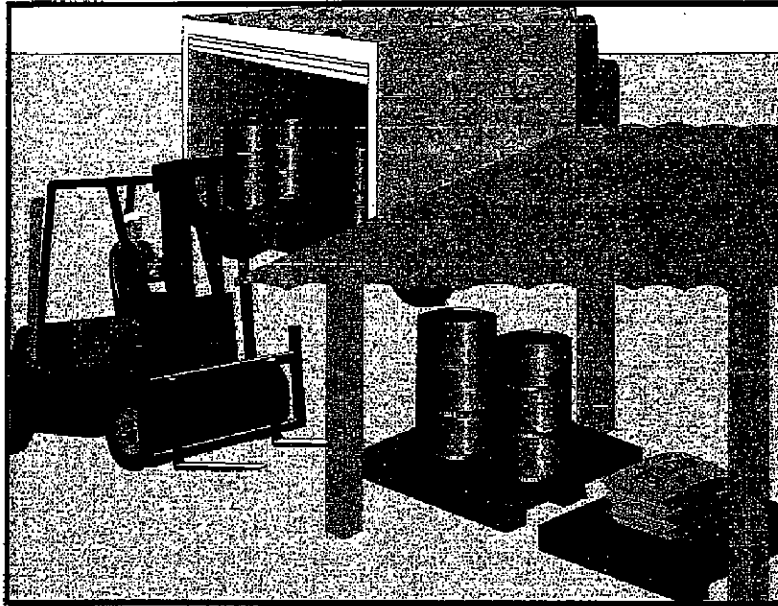

Description and Purpose

Prevent, reduce, or eliminate the discharge of pollutants from material delivery and storage to the stormwater system or watercourses by minimizing the storage of hazardous materials onsite, storing materials in a designated area, installing secondary containment, conducting regular inspections, and training employees and subcontractors.

This best management practice covers only material delivery and storage. For other information on materials, see WM-2, Material Use, or WM-4, Spill Prevention and Control. For information on wastes, see the waste management BMPs in this section.

Suitable Applications

These procedures are suitable for use at all construction sites with delivery and storage of the following materials:

- Soil stabilizers and binders
- Pesticides and herbicides
- Fertilizers
- Detergents
- Plaster
- Petroleum products such as fuel, oil, and grease
- Asphalt and concrete components

Objectives

EC	Erosion Control	
SE	Sediment Control	
TC	Tracking Control	
WE	Wind Erosion Control	
NS	Non-Stormwater Management Control	
WM	Waste Management and Materials Pollution Control	✓

Legend:

- ✓ Primary Objective
- ✓ Secondary Objective

Targeted Constituents

Sediment	✓
Nutrients	✓
Trash	✓
Metals	✓
Bacteria	
Oil and Grease	✓
Organics	✓

Potential Alternatives

None



- Hazardous chemicals such as acids, lime, glues, adhesives, paints, solvents, and curing compounds
- Concrete compounds
- Other materials that may be detrimental if released to the environment

Limitations

- Space limitation may preclude indoor storage.
- Storage sheds often must meet building and fire code requirements.

Implementation

The following steps should be taken to minimize risk:

- Temporary storage area should be located away from vehicular traffic.
- Material Safety Data Sheets (MSDS) should be supplied for all materials stored.
- Construction site areas should be designated for material delivery and storage.
- Material delivery and storage areas should be located near the construction entrances, away from waterways, if possible.
 - Avoid transport near drainage paths or waterways.
 - Surround with earth berms. See EC-9, Earth Dikes and Drainage Swales.
 - Place in an area which will be paved.
- Storage of reactive, ignitable, or flammable liquids must comply with the fire codes of your area. Contact the local Fire Marshal to review site materials, quantities, and proposed storage area to determine specific requirements. See the Flammable and Combustible Liquid Code, NFPA30.
- An up to date inventory of materials delivered and stored onsite should be kept.
- Hazardous materials storage onsite should be minimized.
- Hazardous materials should be handled as infrequently as possible.
- During the rainy season, consider storing materials in a covered area. Store materials in secondary containments such as earthen dike, horse trough, or even a children's wading pool for non-reactive materials such as detergents, oil, grease, and paints. Small amounts of material may be secondarily contained in "bus boy" trays or concrete mixing trays.
- Do not store chemicals, drums, or bagged materials directly on the ground. Place these items on a pallet and, when possible, in secondary containment.

- If drums must be kept uncovered, store them at a slight angle to reduce ponding of rainwater on the lids to reduce corrosion. Domed plastic covers are inexpensive and snap to the top of drums, preventing water from collecting.
- Chemicals should be kept in their original labeled containers.
- Employees and subcontractors should be trained on the proper material delivery and storage practices.
- Employees trained in emergency spill cleanup procedures must be present when dangerous materials or liquid chemicals are unloaded.
- If significant residual materials remain on the ground after construction is complete, properly remove materials and any contaminated soil. See WM-7, Contaminated Soil Management. If the area is to be paved, pave as soon as materials are removed to stabilize the soil.

Material Storage Areas and Practices

- Liquids, petroleum products, and substances listed in 40 CFR Parts 110, 117, or 302 should be stored in approved containers and drums and should not be overfilled. Containers and drums should be placed in temporary containment facilities for storage.
- A temporary containment facility should provide for a spill containment volume able to contain precipitation from a 25 year storm event, plus the greater of 10% of the aggregate volume of all containers or 100% of the capacity of the largest container within its boundary, whichever is greater.
- A temporary containment facility should be impervious to the materials stored therein for a minimum contact time of 72 hours.
- A temporary containment facility should be maintained free of accumulated rainwater and spills. In the event of spills or leaks, accumulated rainwater and spills should be collected and placed into drums. These liquids should be handled as a hazardous waste unless testing determines them to be non-hazardous. All collected liquids or non-hazardous liquids should be sent to an approved disposal site.
- Sufficient separation should be provided between stored containers to allow for spill cleanup and emergency response access.
- Incompatible materials, such as chlorine and ammonia, should not be stored in the same temporary containment facility.
- Throughout the rainy season, each temporary containment facility should be covered during non-working days, prior to, and during rain events.
- Materials should be stored in their original containers and the original product labels should be maintained in place in a legible condition. Damaged or otherwise illegible labels should be replaced immediately.

- Bagged and boxed materials should be stored on pallets and should not be allowed to accumulate on the ground. To provide protection from wind and rain throughout the rainy season, bagged and boxed materials should be covered during non-working days and prior to and during rain events.
- Stockpiles should be protected in accordance with WM-3, Stockpile Management.
- Materials should be stored indoors within existing structures or sheds when available.
- Proper storage instructions should be posted at all times in an open and conspicuous location.
- An ample supply of appropriate spill clean up material should be kept near storage areas.
- Also see WM-6, Hazardous Waste Management, for storing of hazardous materials.

Material Delivery Practices

- Keep an accurate, up-to-date inventory of material delivered and stored onsite.
- Arrange for employees trained in emergency spill cleanup procedures to be present when dangerous materials or liquid chemicals are unloaded.

Spill Cleanup

- Contain and clean up any spill immediately.
- Properly remove and dispose of any hazardous materials or contaminated soil if significant residual materials remain on the ground after construction is complete. See WM-7, Contaminated Soil Management.
- See WM-4, Spill Prevention and Control, for spills of chemicals and/or hazardous materials.

Cost

- The largest cost of implementation may be in the construction of a materials storage area that is covered and provides secondary containment.

Inspection and Maintenance

- Inspect and verify that activity-based BMPs are in place prior to the commencement of associated activities. While activities associated with the BMP are under way, inspect weekly during the rainy season and of two-week intervals in the non-rainy season to verify continued BMP implementation.
- Keep an ample supply of spill cleanup materials near the storage area.
- Keep storage areas clean, well organized, and equipped with ample cleanup supplies as appropriate for the materials being stored.
- Repair or replace perimeter controls, containment structures, covers, and liners as needed to maintain proper function.

References

Blueprint for a Clean Bay: Best Management Practices to Prevent Stormwater Pollution from Construction Related Activities; Santa Clara Valley Nonpoint Source Pollution Control Program, 1995.

Coastal Nonpoint Pollution Control Program: Program Development and Approval Guidance, Working Group Working Paper; USEPA, April 1992.

Stormwater Quality Handbooks - Construction Site Best Management Practices (BMPs) Manual, State of California Department of Transportation (Caltrans), November 2000.

Stormwater Management for Construction Activities; Developing Pollution Prevention Plans and Best Management Practice, EPA 832-R-92005; USEPA, April 1992.

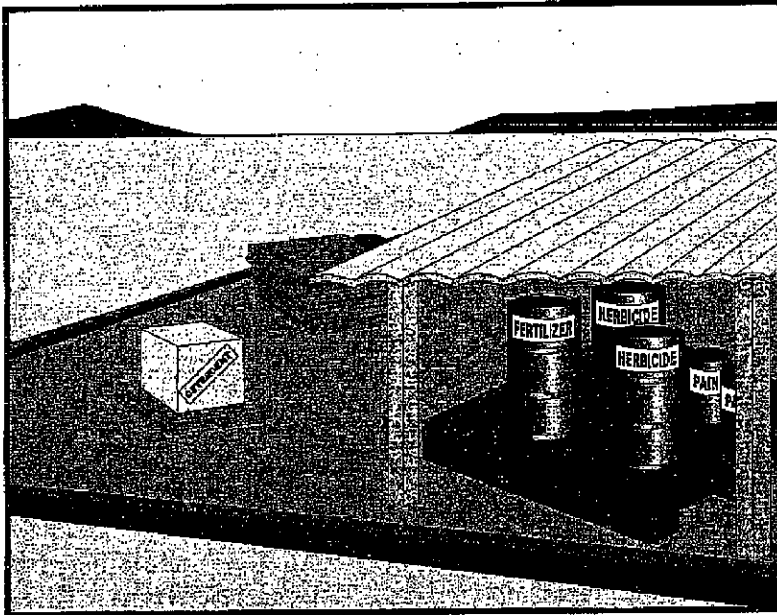

Description and Purpose

Prevent or reduce the discharge of pollutants to the storm drain system or watercourses from material use by using alternative products, minimizing hazardous material use onsite, and training employees and subcontractors.

Suitable Applications

This BMP is suitable for use at all construction projects. These procedures apply when the following materials are used or prepared onsite:

- Pesticides and herbicides
- Fertilizers
- Detergents
- Plaster
- Petroleum products such as fuel, oil, and grease
- Asphalt and other concrete components
- Other hazardous chemicals such as acids, lime, glues, adhesives, paints, solvents, and curing compounds
- Concrete compounds
- Other materials that may be detrimental if released to the environment

Objectives

EC	Erosion Control	
SE	Sediment Control	
TC	Tracking Control	
WE	Wind Erosion Control	
NS	Non-Stormwater Management Control	
WM	Waste Management and Materials Pollution Control	✓

Legend:

- ✓ Primary Objective
- ✓ Secondary Objective

Targeted Constituents

Sediment	✓
Nutrients	✓
Trash	✓
Metals	✓
Bacteria	
Oil and Grease	✓
Organics	✓

Potential Alternatives

None



Limitations

Safer alternative building and construction products may not be available or suitable in every instance.

Implementation

The following steps should be taken to minimize risk:

- Minimize use of hazardous materials onsite.
- Follow manufacturer instructions regarding uses, protective equipment, ventilation, flammability, and mixing of chemicals.
- Train personnel who use pesticides. The California Department of Pesticide Regulation and county agricultural commissioners license pesticide dealers, certify pesticide applicators, and conduct onsite inspections.
- Do not over-apply fertilizers, herbicides, and pesticides. Prepare only the amount needed. Follow the recommended usage instructions. Over-application is expensive and environmentally harmful. Unless on steep slopes, till fertilizers into the soil rather than hydro seeding. Apply surface dressings in several smaller applications, as opposed to one large application, to allow time for infiltration and to avoid excess material being carried offsite by runoff. Do not apply these chemicals just before it rains.
- Train employees and subcontractors in proper material use.
- Supply Material Safety Data Sheets (MSDS) for all materials.
- Dispose of latex paint and paint cans, used brushes, rags, absorbent materials, and drop cloths, when thoroughly dry and are no longer hazardous, with other construction debris.
- Do not remove the original product label; it contains important safety and disposal information. Use the entire product before disposing of the container.
- Mix paint indoors or in a containment area. Never clean paintbrushes or rinse paint containers into a street, gutter, storm drain, or watercourse. Dispose of any paint thinners, residue, and sludge(s) that cannot be recycled, as hazardous waste.
- For water-based paint, clean brushes to the extent practicable, and rinse to a drain leading to a sanitary sewer where permitted, or into a concrete washout pit or temporary sediment trap. For oil-based paints, clean brushes to the extent practicable, and filter and reuse thinners and solvents.
- Use recycled and less hazardous products when practical. Recycle residual paints, solvents, non-treated lumber, and other materials.
- Use materials only where and when needed to complete the construction activity. Use safer alternative materials as much as possible. Reduce or eliminate use of hazardous materials onsite when practical.

- Require contractors to complete the "Report of Chemical Spray Forms" when spraying herbicides and pesticides.
- Keep an ample supply of spill clean up material near use areas. Train employees in spill clean up procedures.
- Avoid exposing applied materials to rainfall and runoff unless sufficient time has been allowed for them to dry.

Costs

All of the above are low cost measures.

Inspection and Maintenance

- Inspect and verify that activity-based BMPs are in place prior to the commencement of associated activities. While activities associated with the BMP are under way, inspect weekly during the rainy season and at two-week intervals in the non-rainy season to verify continued BMP implementation.
- Maintenance of this best management practice is minimal.
- Spot check employees and subcontractors throughout the job to ensure appropriate practices are being employed.

References

Blueprint for a Clean Bay: Best Management Practices to Prevent Stormwater Pollution from Construction Related Activities; Santa Clara Valley Nonpoint Source Pollution Control Program, 1995.

Coastal Nonpoint Pollution Control Program: Program Development and Approval Guidance, Working Group Working Paper; USEPA, April 1992.

Stormwater Quality Handbooks - Construction Site Best Management Practices (BMPs) Manual, State of California Department of Transportation (Caltrans), November 2000.

Stormwater Management for Construction Activities; Developing Pollution Prevention Plans and Best Management Practice, EPA 832-R-92005; USEPA, April 1992.

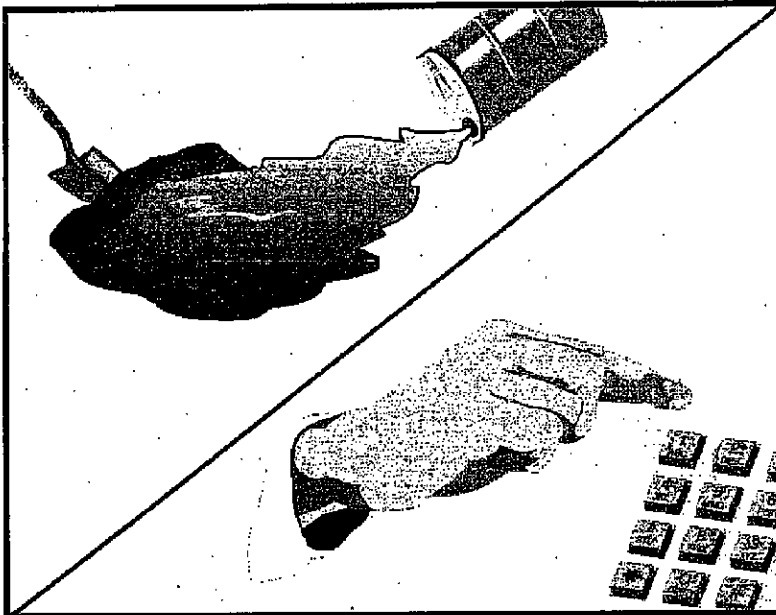

Description and Purpose

Prevent or reduce the discharge of pollutants to drainage systems or watercourses from leaks and spills by reducing the chance for spills, stopping the source of spills, containing and cleaning up spills, properly disposing of spill materials, and training employees.

This best management practice covers only spill prevention and control. However, WM-1, Materials Delivery and Storage, and WM-2, Material Use, also contain useful information, particularly on spill prevention. For information on wastes, see the waste management BMPs in this section.

Suitable Applications

This BMP is suitable for all construction projects. Spill control procedures are implemented anytime chemicals or hazardous substances are stored on the construction site, including the following materials:

- Soil stabilizers/binders
- Dust palliatives
- Herbicides
- Growth inhibitors
- Fertilizers
- Deicing/anti-icing chemicals

Objectives

EC	Erosion Control
SE	Sediment Control
TC	Tracking Control
WE	Wind Erosion Control
NS	Non-Stormwater Management Control
WM	Waste Management and Materials Pollution Control ✓

Legend:

- ✓ Primary Objective
- ✓ Secondary Objective

Targeted Constituents

Sediment	✓
Nutrients	✓
Trash	✓
Metals	✓
Bacteria	
Oil and Grease	✓
Organics	✓

Potential Alternatives

None



- Fuels
- Lubricants
- Other petroleum distillates

Limitations

- In some cases it may be necessary to use a private spill cleanup company.
- This BMP applies to spills caused by the contractor and subcontractors.
- Procedures and practices presented in this BMP are general. Contractor should identify appropriate practices for the specific materials used or stored onsite

Implementation

The following steps will help reduce the stormwater impacts of leaks and spills:

Education

- Be aware that different materials pollute in different amounts. Make sure that each employee knows what a "significant spill" is for each material they use, and what is the appropriate response for "significant" and "insignificant" spills.
- Educate employees and subcontractors on potential dangers to humans and the environment from spills and leaks.
- Hold regular meetings to discuss and reinforce appropriate disposal procedures (incorporate into regular safety meetings).
- Establish a continuing education program to indoctrinate new employees.
- Have contractor's superintendent or representative oversee and enforce proper spill prevention and control measures.

General Measures

- To the extent that the work can be accomplished safely, spills of oil, petroleum products, substances listed under 40 CFR parts 110,117, and 302, and sanitary and septic wastes should be contained and cleaned up immediately.
- Store hazardous materials and wastes in covered containers and protect from vandalism.
- Place a stockpile of spill cleanup materials where it will be readily accessible.
- Train employees in spill prevention and cleanup.
- Designate responsible individuals to oversee and enforce control measures.
- Spills should be covered and protected from stormwater runoff during rainfall to the extent that it doesn't compromise clean up activities.
- Do not bury or wash spills with water.

- Store and dispose of used clean up materials, contaminated materials, and recovered spill material that is no longer suitable for the intended purpose in conformance with the provisions in applicable BMPs.
- Do not allow water used for cleaning and decontamination to enter storm drains or watercourses. Collect and dispose of contaminated water in accordance with WM-10, Liquid Waste Management.
- Contain water overflow or minor water spillage and do not allow it to discharge into drainage facilities or watercourses.
- Place proper storage, cleanup, and spill reporting instructions for hazardous materials stored or used on the project site in an open, conspicuous, and accessible location.
- Keep waste storage areas clean, well organized, and equipped with ample cleanup supplies as appropriate for the materials being stored. Perimeter controls, containment structures, covers, and liners should be repaired or replaced as needed to maintain proper function.

Cleanup

- Clean up leaks and spills immediately.
- Use a rag for small spills on paved surfaces, a damp mop for general cleanup, and absorbent material for larger spills. If the spilled material is hazardous, then the used cleanup materials are also hazardous and must be sent to either a certified laundry (rags) or disposed of as hazardous waste.
- Never hose down or bury dry material spills. Clean up as much of the material as possible and dispose of properly. See the waste management BMPs in this section for specific information.

Minor Spills

- Minor spills typically involve small quantities of oil, gasoline, paint, etc. which can be controlled by the first responder at the discovery of the spill.
- Use absorbent materials on small spills rather than hosing down or burying the spill.
- Absorbent materials should be promptly removed and disposed of properly.
- Follow the practice below for a minor spill:
 - Contain the spread of the spill.
 - Recover spilled materials.
 - Clean the contaminated area and properly dispose of contaminated materials.

Semi-Significant Spills

- Semi-significant spills still can be controlled by the first responder along with the aid of other personnel such as laborers and the foreman, etc. This response may require the cessation of all other activities.

- Spills should be cleaned up immediately:
 - Contain spread of the spill.
 - Notify the project foreman immediately.
 - If the spill occurs on paved or impermeable surfaces, clean up using "dry" methods (absorbent materials, cat litter and/or rags). Contain the spill by encircling with absorbent materials and do not let the spill spread widely.
 - If the spill occurs in dirt areas, immediately contain the spill by constructing an earthen dike. Dig up and properly dispose of contaminated soil.
 - If the spill occurs during rain, cover spill with tarps or other material to prevent contaminating runoff.

Significant/Hazardous Spills

- For significant or hazardous spills that cannot be controlled by personnel in the immediate vicinity, the following steps should be taken:
 - Notify the local emergency response by dialing 911. In addition to 911, the contractor will notify the proper county officials. It is the contractor's responsibility to have all emergency phone numbers at the construction site.
 - Notify the Governor's Office of Emergency Services Warning Center, (916) 845-8911.
 - For spills of federal reportable quantities, in conformance with the requirements in 40 CFR parts 110,119, and 302, the contractor should notify the National Response Center at (800) 424-8802.
 - Notification should first be made by telephone and followed up with a written report.
 - The services of a spills contractor or a Haz-Mat team should be obtained immediately. Construction personnel should not attempt to clean up until the appropriate and qualified staffs have arrived at the job site.
 - Other agencies which may need to be consulted include, but are not limited to, the Fire Department, the Public Works Department, the Coast Guard, the Highway Patrol, the City/County Police Department, Department of Toxic Substances, California Division of Oil and Gas, Cal/OSHA, etc.

Reporting

- Report significant spills to local agencies, such as the Fire Department; they can assist in cleanup.
- Federal regulations require that any significant oil spill into a water body or onto an adjoining shoreline be reported to the National Response Center (NRC) at 800-424-8802 (24 hours).

Use the following measures related to specific activities:

Vehicle and Equipment Maintenance

- If maintenance must occur onsite, use a designated area and a secondary containment, located away from drainage courses, to prevent the runoff of stormwater and the runoff of spills.
- Regularly inspect onsite vehicles and equipment for leaks and repair immediately
- Check incoming vehicles and equipment (including delivery trucks, and employee and subcontractor vehicles) for leaking oil and fluids. Do not allow leaking vehicles or equipment onsite.
- Always use secondary containment, such as a drain pan or drop cloth, to catch spills or leaks when removing or changing fluids.
- Place drip pans or absorbent materials under paving equipment when not in use.
- Use absorbent materials on small spills rather than hosing down or burying the spill. Remove the absorbent materials promptly and dispose of properly.
- Promptly transfer used fluids to the proper waste or recycling drums. Don't leave full drip pans or other open containers lying around
- Oil filters disposed of in trashcans or dumpsters can leak oil and pollute stormwater. Place the oil filter in a funnel over a waste oil-recycling drum to drain excess oil before disposal. Oil filters can also be recycled. Ask the oil supplier or recycler about recycling oil filters.
- Store cracked batteries in a non-leaking secondary container. Do this with all cracked batteries even if you think all the acid has drained out. If you drop a battery, treat it as if it is cracked. Put it into the containment area until you are sure it is not leaking.

Vehicle and Equipment Fueling

- If fueling must occur onsite, use designate areas, located away from drainage courses, to prevent the runoff of stormwater and the runoff of spills.
- Discourage "topping off" of fuel tanks.
- Always use secondary containment, such as a drain pan, when fueling to catch spills/ leaks.

Costs

Prevention of leaks and spills is inexpensive. Treatment and/ or disposal of contaminated soil or water can be quite expensive.

Inspection and Maintenance

- Inspect and verify that activity-based BMPs are in place prior to the commencement of associated activities. While activities associated with the BMP are under way, inspect weekly during the rainy season and of two-week intervals in the non-rainy season to verify continued BMP implementation.
- Inspect BMPs subject to non-stormwater discharge daily while non-stormwater discharges occur.

- Keep ample supplies of spill control and cleanup materials onsite, near storage, unloading, and maintenance areas.
- Update your spill prevention and control plan and stock cleanup materials as changes occur in the types of chemicals onsite.

References

Blueprint for a Clean Bay: Best Management Practices to Prevent Stormwater Pollution from Construction Related Activities; Santa Clara Valley Nonpoint Source Pollution Control Program, 1995.

Stormwater Quality Handbooks - Construction Site Best Management Practices (BMPs) Manual, State of California Department of Transportation (Caltrans), November 2000.

Stormwater Management for Construction Activities; Developing Pollution Prevention Plans and Best Management Practice, EPA 832-R-92005; USEPA, April 1992.

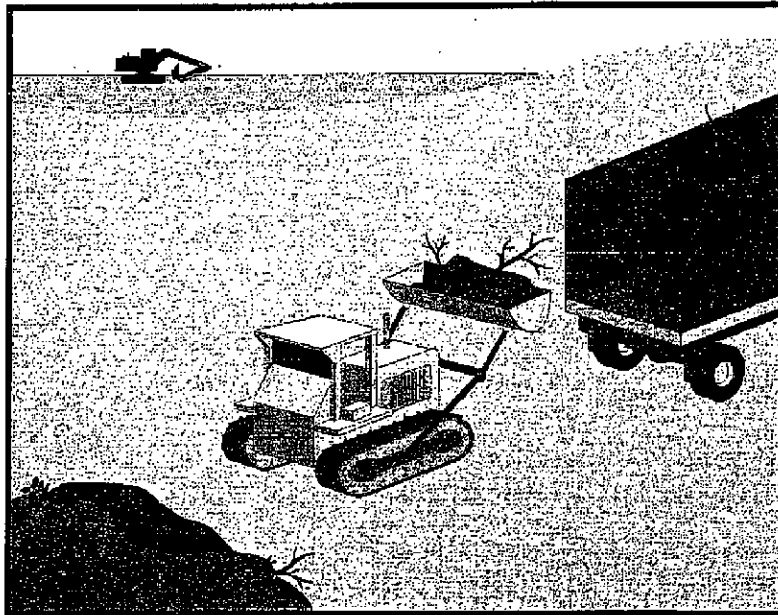

Description and Purpose

Solid waste management procedures and practices are designed to prevent or reduce the discharge of pollutants to stormwater from solid or construction waste by providing designated waste collection areas and containers, arranging for regular disposal, and training employees and subcontractors.

Suitable Applications

This BMP is suitable for construction sites where the following wastes are generated or stored:

- Solid waste generated from trees and shrubs removed during land clearing, demolition of existing structures (rubble), and building construction
- Packaging materials including wood, paper, and plastic
- Scrap or surplus building materials including scrap metals, rubber, plastic, glass pieces and masonry products
- Domestic wastes including food containers such as beverage cans, coffee cups, paper bags, plastic wrappers, and cigarettes
- Construction wastes including brick, mortar, timber, steel and metal scraps, pipe and electrical cuttings, non-hazardous equipment parts, styrofoam and other materials used to transport and package construction materials

Objectives

EC	Erosion Control	
SE	Sediment Control	
TC	Tracking Control	
WE	Wind Erosion Control	
NS	Non-Stormwater Management Control	
WM	Waste Management and Materials Pollution Control	✓

Legend:

- ✓ Primary Objective
- ✓ Secondary Objective

Targeted Constituents

Sediment	✓
Nutrients	✓
Trash	✓
Metals	✓
Bacteria	
Oil and Grease	✓
Organics	✓

Potential Alternatives

None



- Highway planting wastes, including vegetative material, plant containers, and packaging materials

Limitations

Temporary stockpiling of certain construction wastes may not necessitate stringent drainage related controls during the non-rainy season or in desert areas with low rainfall.

Implementation

The following steps will help keep a clean site and reduce stormwater pollution:

- Select designated waste collection areas onsite.
- Inform trash-hauling contractors that you will accept only watertight dumpsters for onsite use. Inspect dumpsters for leaks and repair any dumpster that is not watertight.
- Locate containers in a covered area or in a secondary containment.
- Provide an adequate number of containers with lids or covers that can be placed over the container to keep rain out or to prevent loss of wastes when it is windy.
- Plan for additional containers and more frequent pickup during the demolition phase of construction.
- Collect site trash daily, especially during rainy and windy conditions.
- Remove this solid waste promptly since erosion and sediment control devices tend to collect litter.
- Make sure that toxic liquid wastes (used oils, solvents, and paints) and chemicals (acids, pesticides, additives, curing compounds) are not disposed of in dumpsters designated for construction debris.
- Do not hose out dumpsters on the construction site. Leave dumpster cleaning to the trash hauling contractor.
- Arrange for regular waste collection before containers overflow.
- Clean up immediately if a container does spill.
- Make sure that construction waste is collected, removed, and disposed of only at authorized disposal areas.

Education

- Have the contractor's superintendent or representative oversee and enforce proper solid waste management procedures and practices.
- Instruct employees and subcontractors on identification of solid waste and hazardous waste.
- Educate employees and subcontractors on solid waste storage and disposal procedures.

- Hold regular meetings to discuss and reinforce disposal procedures (incorporate into regular safety meetings).
- Require that employees and subcontractors follow solid waste handling and storage procedures.
- Prohibit littering by employees, subcontractors, and visitors.
- Minimize production of solid waste materials wherever possible.

Collection, Storage, and Disposal

- Littering on the project site should be prohibited.
- To prevent clogging of the storm drainage system, litter and debris removal from drainage grates, trash racks, and ditch lines should be a priority.
- Trash receptacles should be provided in the contractor's yard, field trailer areas, and at locations where workers congregate for lunch and break periods.
- Litter from work areas within the construction limits of the project site should be collected and placed in watertight dumpsters at least weekly, regardless of whether the litter was generated by the contractor, the public, or others. Collected litter and debris should not be placed in or next to drain inlets, stormwater drainage systems, or watercourses.
- Dumpsters of sufficient size and number should be provided to contain the solid waste generated by the project.
- Full dumpsters should be removed from the project site and the contents should be disposed of by the trash hauling contractor.
- Construction debris and waste should be removed from the site biweekly or more frequently as needed.
- Construction material visible to the public should be stored or stacked in an orderly manner.
- Stormwater runoff should be prevented from contacting stored solid waste through the use of berms, dikes, or other temporary diversion structures or through the use of measures to elevate waste from site surfaces.
- Solid waste storage areas should be located at least 50 ft from drainage facilities and watercourses and should not be located in areas prone to flooding or ponding.
- Except during fair weather, construction and highway planting waste not stored in watertight dumpsters should be securely covered from wind and rain by covering the waste with tarps or plastic.
- Segregate potentially hazardous waste from non-hazardous construction site waste.
- Make sure that toxic liquid wastes (used oils, solvents, and paints) and chemicals (acids, pesticides, additives, curing compounds) are not disposed of in dumpsters designated for construction debris.

- For disposal of hazardous waste, see WM-6, Hazardous Waste Management. Have hazardous waste hauled to an appropriate disposal and/or recycling facility.
- Salvage or recycle useful vegetation debris, packaging and surplus building materials when practical. For example, trees and shrubs from land clearing can be used as a brush barrier, or converted into wood chips, then used as mulch on graded areas. Wood pallets, cardboard boxes, and construction scraps can also be recycled.

Costs

All of the above are low cost measures.

Inspection and Maintenance

- Inspect and verify that activity-based BMPs are in place prior to the commencement of associated activities. While activities associated with the BMP are under way, inspect weekly during the rainy season and of two-week intervals in the non-rainy season to verify continued BMP implementation.
- Inspect BMPs subject to non-stormwater discharge daily while non-stormwater discharges occur
- Inspect construction waste area regularly.
- Arrange for regular waste collection.

References

Processes, Procedures and Methods to Control Pollution Resulting from All Construction Activity, 430/9-73-007, USEPA, 1973.

Stormwater Quality Handbooks - Construction Site Best Management Practices (BMPs) Manual, State of California Department of Transportation (Caltrans), November 2000.

Stormwater Management for Construction Activities; Developing Pollution Prevention Plans and Best Management Practice, EPA 832-R-92005; USEPA, April 1992.

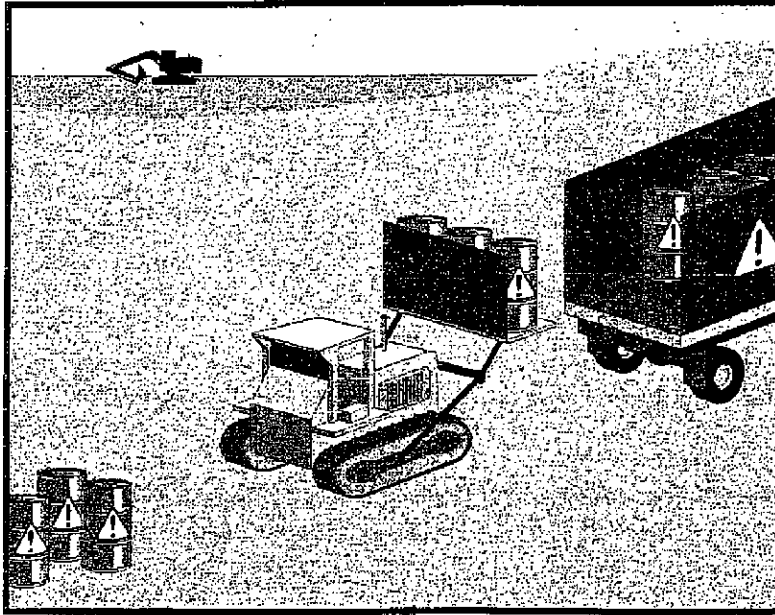

Description and Purpose

Prevent or reduce the discharge of pollutants to stormwater from hazardous waste through proper material use, waste disposal, and training of employees and subcontractors.

Suitable Applications

This best management practice (BMP) applies to all construction projects. Hazardous waste management practices are implemented on construction projects that generate waste from the use of:

- Petroleum Products
- Concrete Curing Compounds
- Palliatives
- Septic Wastes
- Stains
- Wood Preservatives
- Asphalt Products
- Pesticides
- Acids
- Paints
- Solvents
- Roofing Tar
- Any materials deemed a hazardous waste in California, Title 22 Division 4.5, or listed in 40 CFR Parts 110, 117, 261, or 302

Objectives

EC	Erosion Control	
SE	Sediment Control	
TC	Tracking Control	
WE	Wind Erosion Control	
NS	Non-Stormwater Management Control	
WM	Waste Management and Materials Pollution Control	✓

Legend:

- ✓ Primary Objective
- ✓ Secondary Objective

Targeted Constituents

Sediment	
Nutrients	✓
Trash	✓
Metals	✓
Bacteria	✓
Oil and Grease	✓
Organics	✓

Potential Alternatives

None



In addition, sites with existing structures may contain wastes, which must be disposed of in accordance with federal, state, and local regulations. These wastes include:

- Sandblasting grit mixed with lead-, cadmium-, or chromium-based paints
- Asbestos
- PCBs (particularly in older transformers)

Limitations

- Hazardous waste that cannot be reused or recycled must be disposed of by a licensed hazardous waste hauler.
- Nothing in this BMP relieves the contractor from responsibility for compliance with federal, state, and local laws regarding storage, handling, transportation, and disposal of hazardous wastes.
- This BMP does not cover aerially deposited lead (ADL) soils. For ADL soils refer to WM-7, Contaminated Soil Management.

Implementation

The following steps will help reduce stormwater pollution from hazardous wastes:

Material Use

- Wastes should be stored in sealed containers constructed of a suitable material and should be labeled as required by Title 22 CCR, Division 4.5 and 49 CFR Parts 172, 173, 178, and 179.
- All hazardous waste should be stored, transported, and disposed as required in Title 22 CCR, Division 4.5 and 49 CFR 261-263.
- Waste containers should be stored in temporary containment facilities that should comply with the following requirements:
 - Temporary containment facility should provide for a spill containment volume equal to 1.5 times the volume of all containers able to contain precipitation from a 25 year storm event, plus the greater of 10% of the aggregate volume of all containers or 100% of the capacity of the largest tank within its boundary, whichever is greater.
 - Temporary containment facility should be impervious to the materials stored there for a minimum contact time of 72 hours.
 - Temporary containment facilities should be maintained free of accumulated rainwater and spills. In the event of spills or leaks, accumulated rainwater and spills should be placed into drums after each rainfall. These liquids should be handled as a hazardous waste unless testing determines them to be non-hazardous. Non-hazardous liquids should be sent to an approved disposal site.
 - Sufficient separation should be provided between stored containers to allow for spill cleanup and emergency response access.

- Incompatible materials, such as chlorine and ammonia, should not be stored in the same temporary containment facility.
- Throughout the rainy season, temporary containment facilities should be covered during non-working days, and prior to rain events. Covered facilities may include use of plastic tarps for small facilities or constructed roofs with overhangs.
- Drums should not be overfilled and wastes should not be mixed.
- Unless watertight, containers of dry waste should be stored on pallets.
- Do not over-apply herbicides and pesticides. Prepare only the amount needed. Follow the recommended usage instructions. Over application is expensive and environmentally harmful. Apply surface dressings in several smaller applications, as opposed to one large application. Allow time for infiltration and avoid excess material being carried offsite by runoff. Do not apply these chemicals just before it rains. People applying pesticides must be certified in accordance with federal and state regulations.
- Paint brushes and equipment for water and oil based paints should be cleaned within a contained area and should not be allowed to contaminate site soils, watercourses, or drainage systems. Waste paints, thinners, solvents, residues, and sludges that cannot be recycled or reused should be disposed of as hazardous waste. When thoroughly dry, latex paint and paint cans, used brushes, rags, absorbent materials, and drop cloths should be disposed of as solid waste.
- Do not clean out brushes or rinse paint containers into the dirt, street, gutter, storm drain, or stream. "Paint out" brushes as much as possible. Rinse water-based paints to the sanitary sewer. Filter and reuse thinners and solvents. Dispose of excess oil-based paints and sludge as hazardous waste.
- The following actions should be taken with respect to temporary contaminant:
 - Ensure that adequate hazardous waste storage volume is available.
 - Ensure that hazardous waste collection containers are conveniently located.
 - Designate hazardous waste storage areas onsite away from storm drains or watercourses and away from moving vehicles and equipment to prevent accidental spills.
 - Minimize production or generation of hazardous materials and hazardous waste on the job site.
 - Use containment berms in fueling and maintenance areas and where the potential for spills is high.
 - Segregate potentially hazardous waste from non-hazardous construction site debris.
 - Keep liquid or semi-liquid hazardous waste in appropriate containers (closed drums or similar) and under cover.

- Clearly label all hazardous waste containers with the waste being stored and the date of accumulation.
- Place hazardous waste containers in secondary containment.
- Do not allow potentially hazardous waste materials to accumulate on the ground.
- Do not mix wastes.
- Use all of the product before disposing of the container.
- Do not remove the original product label; it contains important safety and disposal information.

Waste Recycling Disposal

- Select designated hazardous waste collection areas onsite.
- Hazardous materials and wastes should be stored in covered containers and protected from vandalism.
- Place hazardous waste containers in secondary containment.
- Do not mix wastes, this can cause chemical reactions, making recycling impossible and complicating disposal.
- Recycle any useful materials such as used oil or water-based paint.
- Make sure that toxic liquid wastes (used oils, solvents, and paints) and chemicals (acids, pesticides, additives, curing compounds) are not disposed of in dumpsters designated for construction debris.
- Arrange for regular waste collection before containers overflow.
- Make sure that hazardous waste (e.g., excess oil-based paint and sludge) is collected, removed, and disposed of only at authorized disposal areas.

Disposal Procedures

- Waste should be disposed of by a licensed hazardous waste transporter at an authorized and licensed disposal facility or recycling facility utilizing properly completed Uniform Hazardous Waste Manifest forms.
- A Department of Health Services certified laboratory should sample waste to determine the appropriate disposal facility.
- Properly dispose of rainwater in secondary containment that may have mixed with hazardous waste.
- Attention is directed to "Hazardous Material", "Contaminated Material", and "Aerially Deposited Lead" of the contract documents regarding the handling and disposal of hazardous materials.

Education

- Educate employees and subcontractors on hazardous waste storage and disposal procedures.
- Educate employees and subcontractors on potential dangers to humans and the environment from hazardous wastes.
- Instruct employees and subcontractors on safety procedures for common construction site hazardous wastes.
- Instruct employees and subcontractors in identification of hazardous and solid waste.
- Hold regular meetings to discuss and reinforce hazardous waste management procedures (incorporate into regular safety meetings).
- The contractor's superintendent or representative should oversee and enforce proper hazardous waste management procedures and practices.
- Make sure that hazardous waste is collected, removed, and disposed of only at authorized disposal areas.
- Warning signs should be placed in areas recently treated with chemicals.
- Place a stockpile of spill cleanup materials where it will be readily accessible.
- If a container does spill, clean up immediately.

Costs

All of the above are low cost measures.

Inspection and Maintenance

- Inspect and verify that activity-based BMPs are in place prior to the commencement of associated activities. While activities associated with the BMP are under way, inspect weekly during the rainy season and of two week intervals in the non-rainy season to verify continued BMP implementation.
- Inspect BMPs subject to non-stormwater discharge daily while non-stormwater discharges occur
- Hazardous waste should be regularly collected.
- A foreman or construction supervisor should monitor onsite hazardous waste storage and disposal procedures.
- Waste storage areas should be kept clean, well organized, and equipped with ample cleanup supplies as appropriate for the materials being stored.
- Perimeter controls, containment structures, covers, and liners should be repaired or replaced as needed to maintain proper function.
- Hazardous spills should be cleaned up and reported in conformance with the applicable Material Safety Data Sheet (MSDS) and the instructions posted at the project site.

- The National Response Center, at (800) 424-8802, should be notified of spills of federal reportable quantities in conformance with the requirements in 40 CFR parts 110, 117, and 302. Also notify the Governors Office of Emergency Services Warning Center at (916) 845-8911.
- A copy of the hazardous waste manifests should be provided.

References

Blueprint for a Clean Bay: Best Management Practices to Prevent Stormwater Pollution from Construction Related Activities; Santa Clara Valley Nonpoint Source Pollution Control Program, 1995.

Processes, Procedures and Methods to Control Pollution Resulting from All Construction Activity, 430/9-73-007, USEPA, 1973.

Stormwater Quality Handbooks - Construction Site Best Management Practices (BMPs) Manual, State of California Department of Transportation (Caltrans), November 2000.

Stormwater Management for Construction Activities; Developing Pollution Prevention Plans and Best Management Practice, EPA 832-R-92005; USEPA, April 1992.

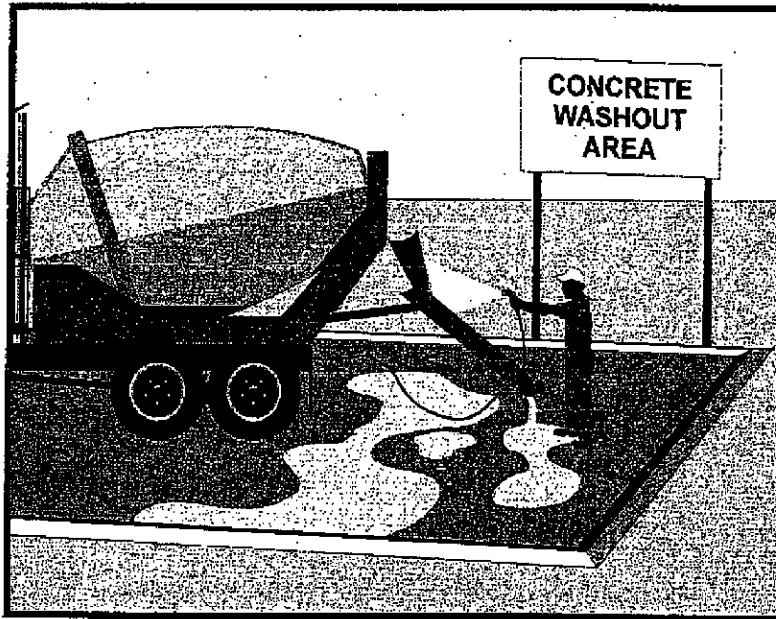

Description and Purpose

Prevent or reduce the discharge of pollutants to stormwater from concrete waste by conducting washout offsite, performing onsite washout in a designated area, and training employee and subcontractors.

Suitable Applications

Concrete waste management procedures and practices are implemented on construction projects where:

- Concrete is used as a construction material or where concrete dust and debris result from demolition activities
- Slurries containing portland cement concrete (PCC) or asphalt concrete (AC) are generated, such as from saw cutting, coring, grinding, grooving, and hydro-concrete demolition
- Concrete trucks and other concrete-coated equipment are washed onsite
- Mortar-mixing stations exist
- See also NS-8, Vehicle and Equipment Cleaning

Limitations

- Offsite washout of concrete wastes may not always be possible.

Objectives

EC	Erosion Control	
SE	Sediment Control	
TC	Tracking Control	
WE	Wind Erosion Control	
NS	Non-Stormwater Management Control	
WM	Waste Management and Materials Pollution Control	✓

Legend:

- ✓ Primary Objective
- ✓ Secondary Objective

Targeted Constituents

Sediment	✓
Nutrients	
Trash	
Metals	✓
Bacteria	
Oil and Grease	
Organics	

Potential Alternatives

None



Implementation

The following steps will help reduce stormwater pollution from concrete wastes:

- Discuss the concrete management techniques described in this BMP (such as handling of concrete waste and washout) with the ready-mix concrete supplier before any deliveries are made.
- Incorporate requirements for concrete waste management into material supplier and subcontractor agreements.
- Store dry and wet materials under cover, away from drainage areas.
- Avoid mixing excess amounts of fresh concrete.
- Perform washout of concrete trucks offsite or in designated areas only.
- Do not wash out concrete trucks into storm drains, open ditches, streets, or streams.
- Do not allow excess concrete to be dumped onsite, except in designated areas.
- For onsite washout:
 - Locate washout area at least 50 feet from storm drains, open ditches, or water bodies. Do not allow runoff from this area by constructing a temporary pit or bermed area large enough for liquid and solid waste.
 - Wash out wastes into the temporary pit where the concrete can set, be broken up, and then disposed properly.
- Avoid creating runoff by draining water to a bermed or level area when washing concrete to remove fine particles and expose the aggregate.
- Do not wash sweepings from exposed aggregate concrete into the street or storm drain. Collect and return sweepings to aggregate base stockpile or dispose in the trash.

Education

- Educate employees, subcontractors, and suppliers on the concrete waste management techniques described herein.
- Arrange for contractor's superintendent or representative to oversee and enforce concrete waste management procedures.

Concrete Slurry Wastes

- PCC and AC waste should not be allowed to enter storm drains or watercourses.
- PCC and AC waste should be collected and disposed of or placed in a temporary concrete washout facility.
- A sign should be installed adjacent to each temporary concrete washout facility to inform concrete equipment operators to utilize the proper facilities.

- Below grade concrete washout facilities are typical. Above grade facilities are used if excavation is not practical.
- A foreman or construction supervisor should monitor onsite concrete working tasks, such as saw cutting, coring, grinding and grooving to ensure proper methods are implemented.
- Saw-cut PCC slurry should not be allowed to enter storm drains or watercourses. Residue from grinding operations should be picked up by means of a vacuum attachment to the grinding machine. Saw cutting residue should not be allowed to flow across the pavement and should not be left on the surface of the pavement. See also NS-3, Paving and Grinding Operations; and WM-10, Liquid Waste Management.
- Slurry residue should be vacuumed and disposed in a temporary pit (as described in OnSite Temporary Concrete Washout Facility, Concrete Transit Truck Washout Procedures, below) and allowed to dry. Dispose of dry slurry residue in accordance with WM-5, Solid Waste Management.

Onsite Temporary Concrete Washout Facility, Transit Truck Washout Procedures

- Temporary concrete washout facilities should be located a minimum of 50 ft from storm drain inlets, open drainage facilities, and watercourses. Each facility should be located away from construction traffic or access areas to prevent disturbance or tracking.
- A sign should be installed adjacent to each washout facility to inform concrete equipment operators to utilize the proper facilities.
- Temporary concrete washout facilities should be constructed above grade or below grade at the option of the contractor. Temporary concrete washout facilities should be constructed and maintained in sufficient quantity and size to contain all liquid and concrete waste generated by washout operations.
- Temporary washout facilities should have a temporary pit or bermed areas of sufficient volume to completely contain all liquid and waste concrete materials generated during washout procedures.
- Washout of concrete trucks should be performed in designated areas only.
- Only concrete from mixer truck chutes should be washed into concrete wash out.
- Concrete washout from concrete pumper bins can be washed into concrete pumper trucks and discharged into designated washout area or properly disposed of offsite.
- Once concrete wastes are washed into the designated area and allowed to harden, the concrete should be broken up, removed, and disposed of per WM-5, Solid Waste Management. Dispose of hardened concrete on a regular basis.
- Temporary Concrete Washout Facility (Type Above Grade)
 - Temporary concrete washout facility (type above grade) should be constructed as shown on the details at the end of this BMP, with a recommended minimum length and

minimum width of 10 ft, but with sufficient quantity and volume to contain all liquid and concrete waste generated by washout operations.

- Straw bales, wood stakes, and sandbag materials should conform to the provisions in SE-9, Straw Bale Barrier.
- Plastic lining material should be a minimum of 10 mil in polyethylene sheeting and should be free of holes, tears, or other defects that compromise the impermeability of the material.
- **Temporary Concrete Washout Facility (Type Below Grade)**
 - Temporary concrete washout facilities (type below grade) should be constructed as shown on the details at the end of this BMP, with a recommended minimum length and minimum width of 10 ft. The quantity and volume should be sufficient to contain all liquid and concrete waste generated by washout operations.
 - Lath and flagging should be commercial type.
 - Plastic lining material should be a minimum of 10 mil polyethylene sheeting and should be free of holes, tears, or other defects that compromise the impermeability of the material.

Removal of Temporary Concrete Washout Facilities

- When temporary concrete washout facilities are no longer required for the work, the hardened concrete should be removed and disposed of. Materials used to construct temporary concrete washout facilities should be removed from the site of the work and disposed of.
- Holes, depressions or other ground disturbance caused by the removal of the temporary concrete washout facilities should be backfilled and repaired.

Costs

All of the above are low cost measures.

Inspection and Maintenance

- Inspect and verify that activity-based BMPs are in place prior to the commencement of associated activities. While activities associated with the BMP are under way, inspect weekly during the rainy season and of two-week intervals in the non-rainy season to verify continued BMP implementation.
- Temporary concrete washout facilities should be maintained to provide adequate holding capacity with a minimum freeboard of 4 in. for above grade facilities and 12 in. for below grade facilities. Maintaining temporary concrete washout facilities should include removing and disposing of hardened concrete and returning the facilities to a functional condition. Hardened concrete materials should be removed and disposed of.
- Washout facilities must be cleaned, or new facilities must be constructed and ready for use once the washout is 75% full.

References

Blueprint for a Clean Bay: Best Management Practices to Prevent Stormwater Pollution from Construction Related Activities; Santa Clara Valley Nonpoint Source Pollution Control Program, 1995.

Stormwater Quality Handbooks - Construction Site Best Management Practices (BMPs) Manual, State of California Department of Transportation (Caltrans), November 2000.

Stormwater Management for Construction Activities; Developing Pollution Prevention Plans and Best Management Practice, EPA 832-R-92005; USEPA, April 1992.

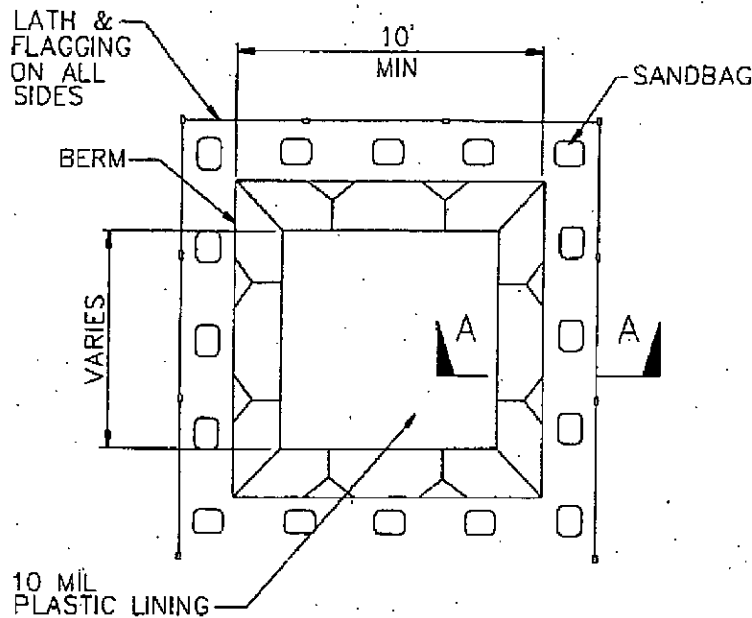

PLAN
NOT TO SCALE
TYPE "BELOW GRADE"

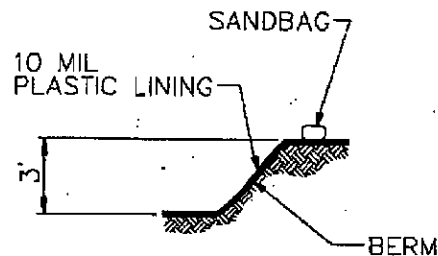

SECTION A-A
NOT TO SCALE

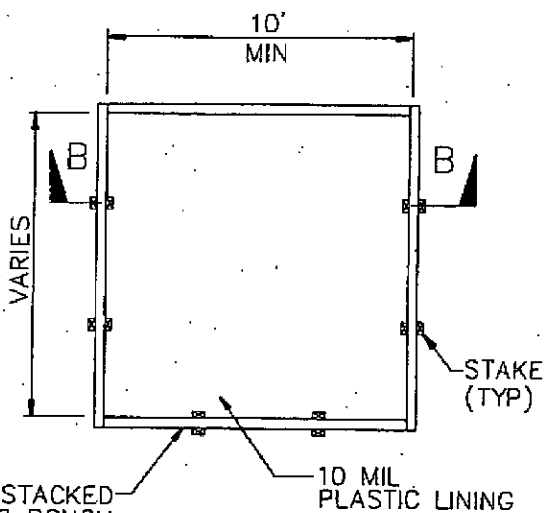

PLAN
NOT TO SCALE
TYPE "ABOVE GRADE"

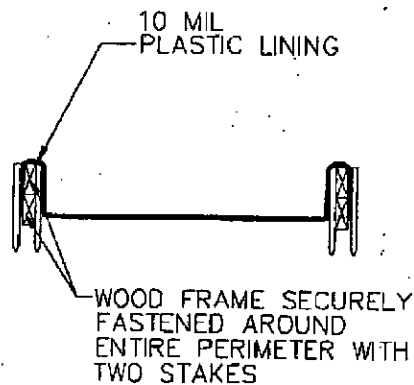

SECTION B-B
NOT TO SCALE

NOTES

1. ACTUAL LAYOUT DETERMINED IN FIELD.
2. THE CONCRETE WASHOUT SIGN SHALL BE INSTALLED WITHIN 30 FT. OF THE TEMPORARY CONCRETE WASHOUT FACILITY.

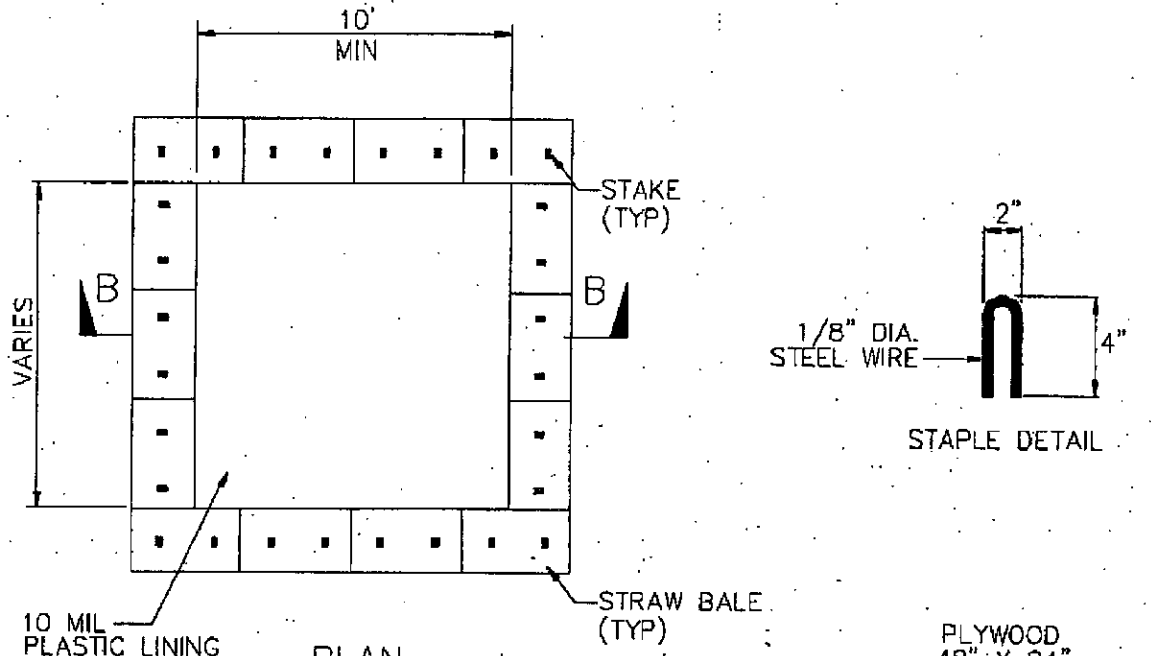

PLAN
NOT TO SCALE
TYPE "ABOVE GRADE"
WITH STRAW BALES

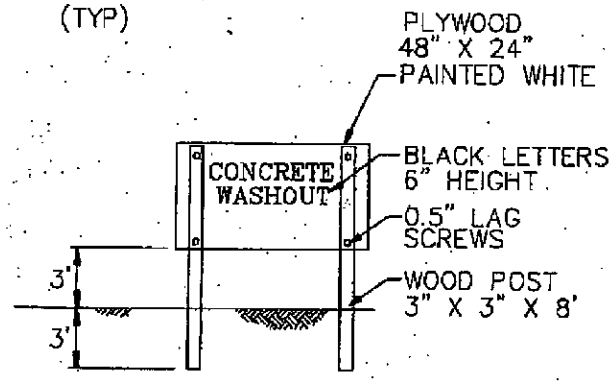

CONCRETE WASHOUT SIGN DETAIL
(OR EQUIVALENT)

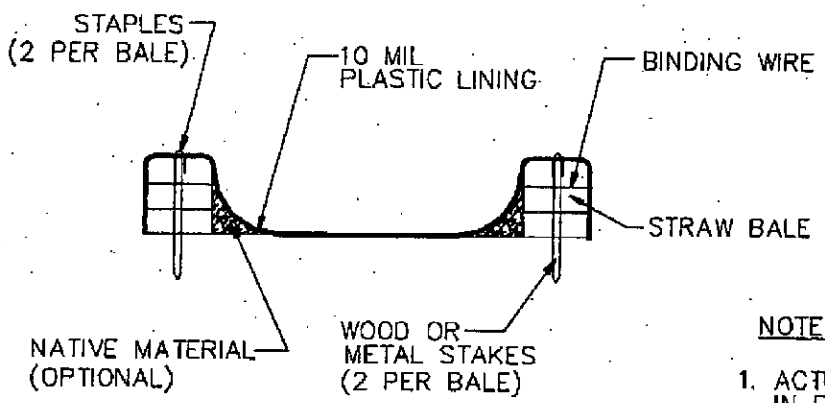

SECTION B-B
NOT TO SCALE

NOTES

1. ACTUAL LAYOUT DETERMINED IN FIELD.
2. THE CONCRETE WASHOUT SIGN SHALL BE INSTALLED WITHIN 30 FT. OF THE TEMPORARY CONCRETE WASHOUT FACILITY.

Sanitary/Septic Waste Management WM-9

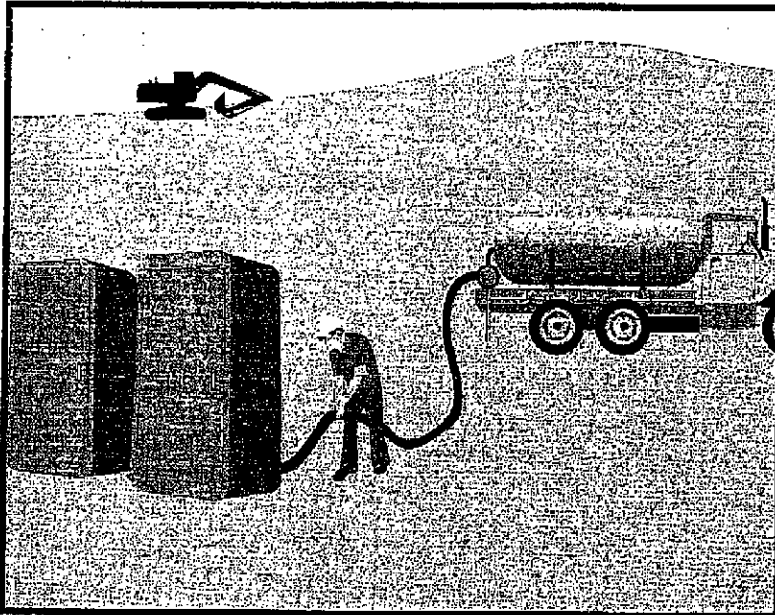

Description and Purpose

Proper sanitary and septic waste management prevent the discharge of pollutants to stormwater from sanitary and septic waste by providing convenient, well-maintained facilities, and arranging for regular service and disposal.

Suitable Applications

Sanitary septic waste management practices are suitable for use at all construction sites that use temporary or portable sanitary and septic waste systems.

Limitations

None identified.

Implementation

Sanitary or septic wastes should be treated or disposed of in accordance with state and local requirements. In many cases, one contract with a local facility supplier will be all that it takes to make sure sanitary wastes are properly disposed.

Storage and Disposal Procedures

- Temporary sanitary facilities should be located away from drainage facilities, watercourses, and from traffic circulation. When subjected to high winds or risk of high winds, temporary sanitary facilities should be secured to prevent overturning.
- Wastewater should not be discharged or buried within the project site.

Objectives

EC	Erosion Control	
SE	Sediment Control	
TC	Tracking Control	
WE	Wind Erosion Control	
NS	Non-Stormwater Management Control	
WM	Waste Management and Materials Pollution Control	✓

Legend:

- ✓ Primary Objective
- ✓ Secondary Objective

Targeted Constituents

Sediment	
Nutrients	✓
Trash	✓
Metals	
Bacteria	✓
Oil and Grease	
Organics	✓

Potential Alternatives

None



WM-9 Sanitary/Septic Waste Management

- Sanitary and septic systems that discharge directly into sanitary sewer systems, where permissible, should comply with the local health agency, city, county, and sewer district requirements.
- Only reputable, licensed sanitary and septic waste haulers should be used.
- Sanitary facilities should be located in a convenient location.
- Untreated raw wastewater should never be discharged or buried.
- Temporary septic systems should treat wastes to appropriate levels before discharging.
- If using an onsite disposal system (OSDS), such as a septic system, local health agency requirements must be followed.
- Temporary sanitary facilities that discharge to the sanitary sewer system should be properly connected to avoid illicit discharges.
- Sanitary and septic facilities should be maintained in good working order by a licensed service.
- Regular waste collection by a licensed hauler should be arranged before facilities overflow.

Education

- Educate employees, subcontractors, and suppliers on sanitary and septic waste storage and disposal procedures.
- Educate employees, subcontractors, and suppliers of potential dangers to humans and the environment from sanitary and septic wastes.
- Instruct employees, subcontractors, and suppliers in identification of sanitary and septic waste.
- Hold regular meetings to discuss and reinforce disposal procedures (incorporate into regular safety meetings).
- Establish a continuing education program to indoctrinate new employees.

Costs

All of the above are low cost measures.

Inspection and Maintenance

- Inspect and verify that activity-based BMPs are in place prior to the commencement of associated activities. While activities associated with the BMP are under way, inspect weekly during the rainy season and of two-week intervals in the non-rainy season to verify continued BMP implementation.
- Arrange for regular waste collection.
- If high winds are expected, portable sanitary facilities must be secured with spikes or weighed down to prevent over turning.

Sanitary/Septic Waste Management WM-9

References

Stormwater Quality Handbooks - Construction Site Best Management Practices (BMPs) Manual, State of California Department of Transportation (Caltrans), November 2000.

Stormwater Management for Construction Activities; Developing Pollution Prevention Plans and Best Management Practice, EPA 832-R-92005; USEPA, April 1992.

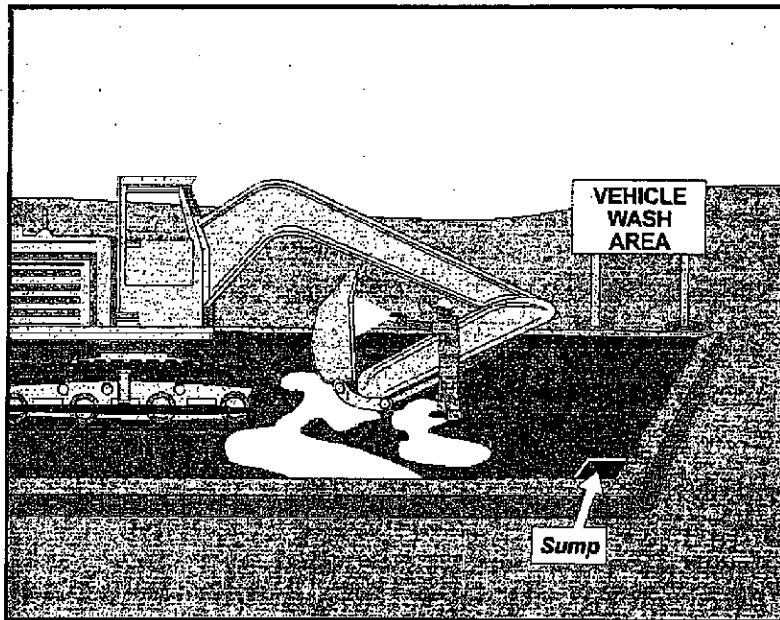

Description and Purpose

Vehicle and equipment cleaning procedures and practices prevent or reduce the discharge of pollutants to stormwater from vehicle and equipment cleaning by using offsite facilities; washing in designated, contained areas only; eliminating discharges to the storm drain by infiltrating the wash water; and training employees and subcontractors.

Suitable Applications

These procedures are suitable on all construction sites where vehicle and equipment cleaning is performed.

Limitations

Even phosphate-free, biodegradable soaps have been shown to be toxic to fish before the soap degrades. Sending vehicles/equipment offsite should be done in conjunction with TC-1, Stabilized Construction Entrance/ Exit.

Implementation

Use an offsite commercial washing business as much as possible. These businesses are better equipped to handle and dispose of the wash waters properly. Performing this work offsite can also be economical by eliminating the need for a separate washing operation onsite.

- Use phosphate-free, biodegradable soaps.
- Educate employees and subcontractors on pollution prevention measures.

Objectives

EC	Erosion Control	
SE	Sediment Control	
TC	Tracking Control	
WE	Wind Erosion Control	
NS	Non-Stormwater Management Control	✓
WM	Waste Management and Materials Pollution Control	

Legend:

- ✓ Primary Objective
- ✓ Secondary Objective

Targeted Constituents

Sediment	✓
Nutrients	✓
Trash	
Metals	
Bacteria	
Oil and Grease	✓
Organics	✓

Potential Alternatives

None



NS-8 Vehicle and Equipment Cleaning

- Do not permit steam cleaning onsite. Steam cleaning can generate significant pollutant concentrates.
- Cleaning of vehicles and equipment with soap, solvents or steam should not occur on the project site unless resulting wastes are fully contained and disposed of. Resulting wastes should not be discharged or buried, and must be captured and recycled or disposed according to the requirements of WM-10, Liquid Waste Management or WM-6, Hazardous Waste Management, depending on the waste characteristics. Minimize use of solvents. Use of diesel for vehicle and equipment cleaning is prohibited.
- All vehicles and equipment that regularly enter and leave the construction site must be cleaned offsite.
- When vehicle and equipment washing and cleaning must occur onsite, and the operation cannot be located within a structure or building equipped with appropriate disposal facilities, the outside cleaning area should have the following characteristics:
 - Located away from storm drain inlets, drainage facilities, or watercourses
 - Paved with concrete or asphalt and bermed to contain wash waters and to prevent runoff and runoff
 - Configured with a sump to allow collection and disposal of wash water
 - No discharge of wash waters to storm drains or watercourses
 - Used only when necessary
- When cleaning vehicles and equipment with water:
 - Use as little water as possible. High-pressure sprayers may use less water than a hose and should be considered
 - Use positive shutoff valve to minimize water usage
 - Facility wash racks should discharge to a sanitary sewer, recycle system or other approved discharge system and should not discharge to the storm drainage system, watercourses, or to groundwater

Costs

Cleaning vehicles and equipment at an offsite facility may reduce overall costs for vehicle and equipment cleaning by eliminating the need to provide similar services onsite. When onsite cleaning is needed, the cost to establish appropriate facilities is relatively low on larger, long-duration projects, and moderate to high on small, short-duration projects.

Inspection and Maintenance

- Inspect and verify that activity-based BMPs are in place prior to the commencement of associated activities. While activities associated with the BMP are under way, inspect weekly during the rainy season and at two-week intervals in the non-rainy season to verify continued BMP implementation.

- Inspect BMPs subject to non-stormwater discharges daily while non-stormwater discharges occur.
- Inspection and maintenance is minimal, although some berm repair may be necessary.
- Monitor employees and subcontractors throughout the duration of the construction project to ensure appropriate practices are being implemented.
- Inspect sump regularly and remove liquids and sediment as needed.
- Prohibit employees and subcontractors from washing personal vehicles and equipment on the construction site.

References

Stormwater Quality Handbooks - Construction Site Best Management Practices (BMPs) Manual, State of California Department of Transportation (Caltrans), November 2000.

Swisher, R.D. Surfactant Biodegradation, Marcel Decker Corporation, 1987.

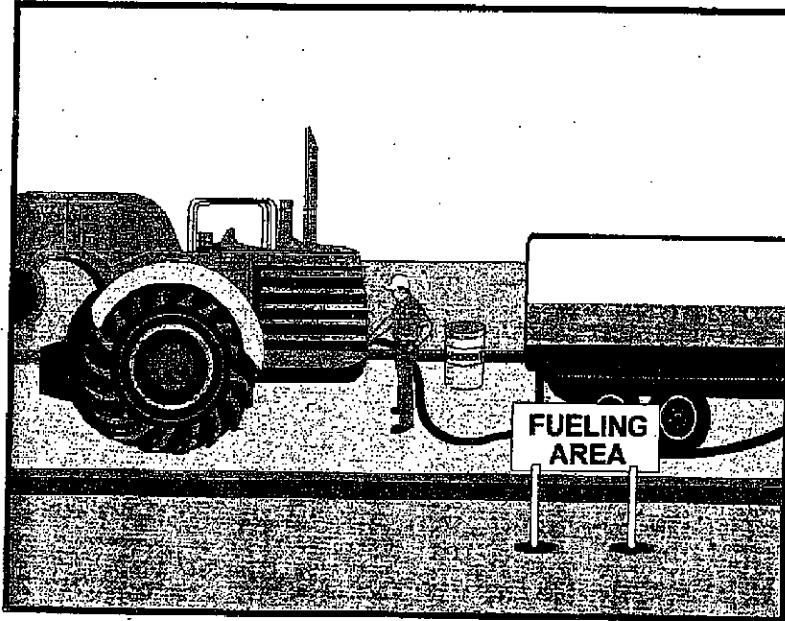

Objectives

- EC Erosion Control
- SE Sediment Control
- TC Tracking Control
- WE Wind Erosion Control
- NS Non-Stormwater Management Control ✓
- WM Waste Management and Materials Pollution Control

Legend:

- ✓ Primary Objective
- ✓ Secondary Objective

Targeted Constituents

- Sediment
- Nutrients
- Trash
- Metals
- Bacteria
- Oil and Grease ✓
- Organics

Potential Alternatives

None

Description and Purpose

Vehicle equipment fueling procedures and practices are designed to prevent fuel spills and leaks, and reduce or eliminate contamination of stormwater. This can be accomplished by using offsite facilities, fueling in designated areas only, enclosing or covering stored fuel, implementing spill controls, and training employees and subcontractors in proper fueling procedures.

Suitable Applications

These procedures are suitable on all construction sites where vehicle and equipment fueling takes place.

Limitations

Onsite vehicle and equipment fueling should only be used where it is impractical to send vehicles and equipment offsite for fueling. Sending vehicles and equipment offsite should be done in conjunction with TC-1, Stabilized Construction Entrance/ Exit.

Implementation

- Use offsite fueling stations as much as possible. These businesses are better equipped to handle fuel and spills properly. Performing this work offsite can also be economical by eliminating the need for a separate fueling area at a site.
- Discourage "topping-off" of fuel tanks.



NS-9 Vehicle and Equipment Fueling

- Absorbent spill cleanup materials and spill kits should be available in fueling areas and on fueling trucks, and should be disposed of properly after use.
- Drip pans or absorbent pads should be used during vehicle and equipment fueling, unless the fueling is performed over an impermeable surface in a dedicated fueling area.
- Use absorbent materials on small spills. Do not hose down or bury the spill. Remove the adsorbent materials promptly and dispose of properly.
- Avoid mobile fueling of mobile construction equipment around the site; rather, transport the equipment to designated fueling areas. With the exception of tracked equipment such as bulldozers and large excavators, most vehicles should be able to travel to a designated area with little lost time.
- Train employees and subcontractors in proper fueling and cleanup procedures.
- When fueling must take place onsite, designate an area away from drainage courses to be used. Fueling areas should be identified in the SWPPP.
- Dedicated fueling areas should be protected from stormwater runoff and should be located at least 50 ft away from downstream drainage facilities and watercourses. Fueling must be performed on level-grade areas.
- Protect fueling areas with berms and dikes to prevent runoff, and to contain spills.
- Nozzles used in vehicle and equipment fueling should be equipped with an automatic shutoff to control drips. Fueling operations should not be left unattended.
- Use vapor recovery nozzles to help control drips as well as air pollution where required by Air Quality Management Districts (AQMD).
- Federal, state, and local requirements should be observed for any stationary above ground storage tanks.

Costs

- All of the above measures are low cost except for the capital costs of above ground tanks that meet all local environmental, zoning, and fire codes.

Inspection and Maintenance

- Vehicles and equipment should be inspected each day of use for leaks. Leaks should be repaired immediately or problem vehicles or equipment should be removed from the project site.
- Keep ample supplies of spill cleanup materials onsite.
- Immediately clean up spills and properly dispose of contaminated soil and cleanup materials.

References

Blueprint for a Clean Bay: Best Management Practices to Prevent Stormwater Pollution from Construction Related Activities; Santa Clara Valley Nonpoint Source Pollution Control Program, 1995.

Coastal Nonpoint Pollution Control Program: Program Development and Approval Guidance, Working Group Working Paper; USEPA, April 1992.

Stormwater Quality Handbooks - Construction Site Best Management Practices (BMPs) Manual, State of California Department of Transportation (Caltrans), November 2000.

Stormwater Management for Construction Activities, Developing Pollution Prevention Plans and Best Management Practices, EPA 832-R-92005; USEPA, April 1992.

Vehicle & Equipment Maintenance NS-10

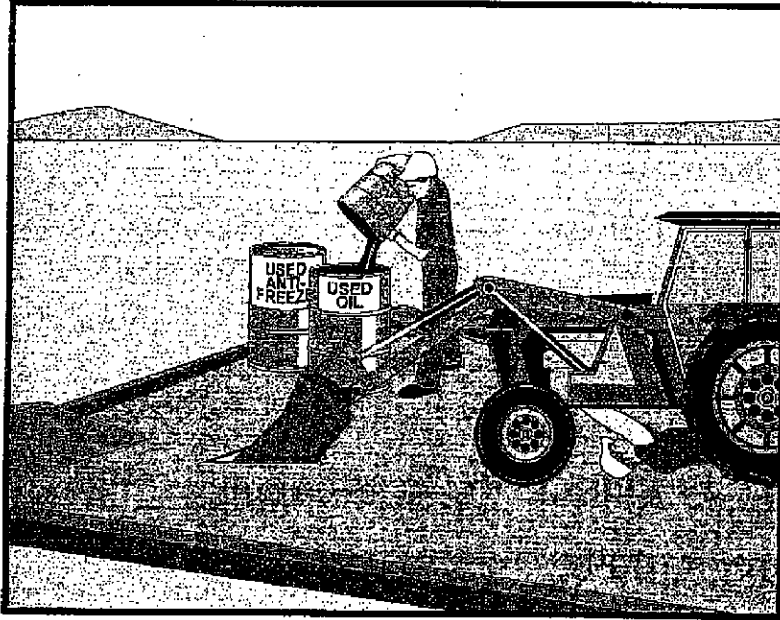

Description and Purpose

Prevent or reduce the contamination of stormwater resulting from vehicle and equipment maintenance by running a "dry and clean site". The best option would be to perform maintenance activities at an offsite facility. If this option is not available then work should be performed in designated areas only, while providing cover for materials stored outside, checking for leaks and spills, and containing and cleaning up spills immediately. Employees and subcontractors must be trained in proper procedures.

Suitable Applications

These procedures are suitable on all construction projects where an onsite yard area is necessary for storage and maintenance of heavy equipment and vehicles.

Limitations

Onsite vehicle and equipment maintenance should only be used where it is impractical to send vehicles and equipment offsite for maintenance and repair. Sending vehicles/equipment offsite should be done in conjunction with TC-1, Stabilized Construction Entrance/Exit.

Outdoor vehicle or equipment maintenance is a potentially significant source of stormwater pollution. Activities that can contaminate stormwater include engine repair and service, changing or replacement of fluids, and outdoor equipment storage and parking (engine fluid leaks). For further information on vehicle or equipment servicing, see NS-8, Vehicle and Equipment Cleaning, and NS-9, Vehicle and Equipment Fueling.

Objectives

EC	Erosion Control	
SE	Sediment Control	
TC	Tracking Control	
WE	Wind Erosion Control	
NS	Non-Stormwater Management Control	✓
WM	Waste Management and Materials Pollution Control	

Legend:

- ✓ Primary Objective
- ✓ Secondary Objective

Targeted Constituents

Sediment	
Nutrients	✓
Trash	✓
Metals	
Bacteria	
Oil and Grease	✓
Organics	✓

Potential Alternatives

None



NS-10 Vehicle & Equipment Maintenance

Implementation

- Use offsite repair shops as much as possible. These businesses are better equipped to handle vehicle fluids and spills properly. Performing this work offsite can also be economical by eliminating the need for a separate maintenance area.
- If maintenance must occur onsite, use designated areas, located away from drainage courses. Dedicated maintenance areas should be protected from stormwater runoff and should be located at least 50 ft from downstream drainage facilities and watercourses.
- Drip pans or absorbent pads should be used during vehicle and equipment maintenance work that involves fluids, unless the maintenance work is performed over an impermeable surface in a dedicated maintenance area.
- Place a stockpile of spill cleanup materials where it will be readily accessible.
- All fueling trucks and fueling areas are required to have spill kits and/or use other spill protection devices.
- Use adsorbent materials on small spills. Remove the adsorbent materials promptly and dispose of properly.
- Inspect onsite vehicles and equipment daily at startup for leaks, and repair immediately.
- Keep vehicles and equipment clean; do not allow excessive build-up of oil and grease.
- Segregate and recycle wastes, such as greases, used oil or oil filters, antifreeze, cleaning solutions, automotive batteries, hydraulic and transmission fluids. Provide secondary containment and covers for these materials if stored onsite.
- Train employees and subcontractors in proper maintenance and spill cleanup procedures.
- Drip pans or plastic sheeting should be placed under all vehicles and equipment placed on docks, barges, or other structures over water bodies when the vehicle or equipment is planned to be idle for more than 1 hour.
- For long-term projects, consider using portable tents or covers over maintenance areas if maintenance cannot be performed offsite.
- Consider use of new, alternative greases and lubricants, such as adhesive greases, for chassis lubrication and fifth-wheel lubrication.
- Properly dispose of used oils, fluids, lubricants, and spill cleanup materials.
- Do not place used oil in a dumpster or pour into a storm drain or watercourse.
- Properly dispose of or recycle used batteries.
- Do not bury used tires.
- Repair leaks of fluids and oil immediately.

Vehicle & Equipment Maintenance NS-10

Listed below is further information if you must perform vehicle or equipment maintenance onsite.

Safer Alternative Products

- Consider products that are less toxic or hazardous than regular products. These products are often sold under an "environmentally friendly" label.
- Consider use of grease substitutes for lubrication of truck fifth-wheels. Follow manufacturers label for details on specific uses.
- Consider use of plastic friction plates on truck fifth-wheels in lieu of grease. Follow manufacturers label for details on specific uses.

Waste Reduction

Parts are often cleaned using solvents such as trichloroethylene, trichloroethane, or methylene chloride. Many of these cleaners are listed in California Toxic Rule as priority pollutants. These materials are harmful and must not contaminate stormwater. They must be disposed of as a hazardous waste. Reducing the number of solvents makes recycling easier and reduces hazardous waste management costs. Often, one solvent can perform a job as well as two different solvents. Also, if possible, eliminate or reduce the amount of hazardous materials and waste by substituting non-hazardous or less hazardous materials. For example, replace chlorinated organic solvents with non-chlorinated solvents. Non-chlorinated solvents like kerosene or mineral spirits are less toxic and less expensive to dispose of properly. Check the list of active ingredients to see whether it contains chlorinated solvents. The "chlor" term indicates that the solvent is chlorinated. Also, try substituting a wire brush for solvents to clean parts.

Recycling and Disposal

Separating wastes allows for easier recycling and may reduce disposal costs. Keep hazardous wastes separate, do not mix used oil solvents, and keep chlorinated solvents (like, -trichloroethane) separate from non-chlorinated solvents (like kerosene and mineral spirits). Promptly transfer used fluids to the proper waste or recycling drums. Don't leave full drip pans or other open containers lying around. Provide cover and secondary containment until these materials can be removed from the site.

Oil filters can be recycled. Ask your oil supplier or recycler about recycling oil filters.

Do not dispose of extra paints and coatings by dumping liquid onto the ground or throwing it into dumpsters. Allow coatings to dry or harden before disposal into covered dumpsters.

Store cracked batteries in a non-leaking secondary container. Do this with all cracked batteries, even if you think all the acid has drained out. If you drop a battery, treat it as if it is cracked. Put it into the containment area until you are sure it is not leaking.

Costs

All of the above are low cost measures. Higher costs are incurred to setup and maintain onsite maintenance areas.

NS-10 Vehicle & Equipment Maintenance

Inspection and Maintenance

- Inspect and verify that activity-based BMPs are in place prior to the commencement of associated activities. While activities associated with the BMP are under way, inspect weekly during the rainy season and at two-week intervals in the non-rainy season to verify continued BMP implementation.
- Inspect BMPs subject to non-stormwater discharges daily while non-stormwater discharges occur.
- Keep ample supplies of spill cleanup materials onsite.
- Maintain waste fluid containers in leak proof condition.
- Vehicles and equipment should be inspected on each day of use. Leaks should be repaired immediately or the problem vehicle(s) or equipment should be removed from the project site.
- Inspect equipment for damaged hoses and leaky gaskets routinely. Repair or replace as needed.

References

Blueprint for a Clean Bay: Best Management Practices to Prevent Stormwater Pollution from Construction Related Activities; Santa Clara Valley Nonpoint Source Pollution Control Program, 1995.

Coastal Nonpoint Pollution Control Program; Program Development and Approval Guidance, Working Group, Working Paper; USEPA, April 1992.

Stormwater Quality Handbooks - Construction Site Best Management Practices (BMPs) Manual, State of California Department of Transportation (Caltrans), November 2000.