

# **APPENDIX F**

---

*Geotechnical Studies*

*Stony Point Site – Geologic and Geotechnical Evaluation*

DRAFT GEOLOGIC AND  
GEOTECHNICAL EVALUATION

---

STATION CASINOS PROJECT "G"  
ROHNERT PARK, CALIFORNIA



**GEOCON**

CONSULTANTS, INC.

GEOTECHNICAL  
ENVIRONMENTAL  
MATERIALS

PREPARED FOR

STATION CASINOS, INC.  
ROCKLIN, CALIFORNIA

DRAFT

OCTOBER 2003

REVISED JANUARY 2004

Project No. S8689-06-02  
October 7, 2003  
Revised January 15, 2004

Mr. Joe Imbriani  
Station Casinos, Inc.  
575 Menlo Drive, Suite 3  
Rocklin, California 95765

Subject: STATION CASINOS PROJECT "G"  
ROHNERT PARK, CALIFORNIA  
DRAFT GEOLOGIC AND GEOTECHNICAL EVALUATION

Dear Mr. Imbriani:

In accordance with your request, Geocon has performed a geologic and geotechnical evaluation of the subject project. The study was conducted to determine the site soil and geologic conditions, and to identify potential geologic hazards that may impact the property with respect to future development.

The accompanying report presents the findings of our preliminary study with respect to the geotechnical aspects of site development. In general, no soil or geologic conditions were encountered that would preclude development of the property as planned.

Should you have questions regarding this report, or if we may be of further service, please contact the undersigned at your convenience.

Sincerely,

GEOCON CONSULTANTS, INC.

**DRAFT**

Jeremy J. Zorne, PE  
Sr. Project Engineer

JJZ:DJK:res

**DRAFT**

Daniel J. Koelzer, GE  
Senior Engineer

- (2) Addressee
- (2) Analytical Environmental Services, Mr. Chad Broussard

## TABLE OF CONTENTS

1.0	PURPOSE AND SCOPE.....	1
2.0	SITE AND PROJECT DESCRIPTION.....	2
2.1	Site Description.....	2
2.2	Project Description.....	2
3.0	SOIL AND GEOLOGIC CONDITIONS.....	4
3.1	Basin Deposits (Qb).....	4
3.2	Fluvial Deposits (Qyfo).....	5
3.3	Alluvial Fan Deposits (Qof).....	5
3.4	Groundwater.....	5
4.0	GEOLOGIC HAZARDS.....	6
4.1	Faulting and Seismicity.....	6
4.1.1	Deterministic Analysis.....	6
4.1.2	Probabilistic Seismic Hazard Analysis.....	7
4.1.3	Liquefaction.....	8
4.1.4	Lateral Spreading.....	9
4.1.5	Seismically Induced Flooding.....	9
4.2	Slope Stability, Landslides.....	10
4.3	Expansive Soil.....	10
4.4	Soil Corrosivity.....	10
4.5	Subsidence.....	10
4.6	Flooding.....	10
5.0	CONCLUSIONS AND RECOMMENDATIONS.....	11
5.1	General.....	11
5.2	Grading - Earthwork.....	12
5.3	Foundations.....	13
5.4	Underground Utility Construction.....	15
5.5	Pavement - Roadways.....	15
5.6	Design-Level Geotechnical Study.....	16
6.0	LIMITATIONS AND UNIFORMITY OF CONDITIONS.....	17
7.0	LIST OF REFERENCES.....	18

TABLE OF CONTENTS (continued)

APPENDIX A – MAPS AND ILLUSTRATIONS

- Figure 1, Vicinity Map
- Figure 2, Site Plan/Geologic Map
- Figure 3, Regional Fault Map
- Figure 4, Liquefaction Susceptibility Map
- Figure 5, FEMA Flood Zone Map

APPENDIX B – FIELD INVESTIGATION

- Logs of Exploratory Borings – Figures B1 through B13
- Logs of CPT Soundings

APPENDIX C – LABORATORY TESTING PROGRAM

- In-Situ Dry Density and Moisture Content
- Atterberg Limits
- Grain Size Distribution
- Expansion Index
- Unconfined Compressive Strength
- Corrosion Potential

DRAFT

# DRAFT GEOLOGIC AND GEOTECHNICAL EVALUATION

## 1.0 PURPOSE AND SCOPE

The purpose of this geologic and geotechnical evaluation was to identify the soil and geologic conditions at the site, determine the presence of geologic hazards and to provide preliminary geotechnical recommendations with respect to development of the proposed casino complex at the project site (see *Vicinity Map*, Figure 1 in Appendix A). Additional design-level studies, including additional subsurface exploration, laboratory testing and geotechnical engineering analysis will be required prior to development of the site improvement plans.

The scope of our study consisted of a review of published geologic literature and other documentation provided by the project team (see *List of References*, Section 7.0 of this report), performing a site reconnaissance, and performing exploratory subsurface explorations at the site. Specifically, our study included the following:

- Reviewed area geologic maps and other literature pertaining to the site and vicinity.
- Reviewed stereoscopic aerial photographs of the site.
- Performed field mapping by an engineering geologist to identify the soil and geologic units and to determine the approximate areal extent of the units.
- Notified the local subscribing utility companies via Underground Service Alert (USA), as required by law, to determine the location of underground utilities in the vicinity of proposed exploratory excavation locations.
- Submitted requisite fees and obtained a geotechnical boring permit from the Sonoma County Permit and Resource Management Department (PRMD).
- Advanced eleven exploratory borings (B1 through B11) at the site with a truck-mounted drill rig equipped with hollow-stem augers. The borings were advanced to approximate depths ranging from 15 to 50 feet below the ground surface (bgs). The approximate exploratory boring locations are depicted on the *Site Plan/Geologic Map*, Figure 2 in Appendix A. The exploratory borings were logged by a California Certified Engineering Geologist. Logs of the exploratory borings are included in Appendix B, Figures B1 through B13.
- Advanced six cone penetration test (CPT) soundings (CPT-1 through CPT-6) at the site with a 20-ton CPT rig. The CPT soundings were advanced to approximate depths ranging from 50 to 80 feet bgs. The approximate CPT sounding locations are depicted on the *Site Plan/Geologic Map*, Figure 2 in Appendix A. Electronic logs of the CPT soundings are included in Appendix B.
- Obtained relatively undisturbed and bulk soil samples from the exploratory borings. Performed geotechnical laboratory tests on selected soil samples to determine soil index and engineering properties including in situ density and moisture content, plasticity characteristics, consolidation potential, and shear strength parameters. Laboratory test procedures and results are included in Appendix C.

## 2.0 SITE AND PROJECT DESCRIPTION

### 2.1 Site Description

The proposed project area consists of several parcels totaling approximately 360 acres of agricultural land located west of US Highway 101, just outside the city limits of Rohnert Park, California. The site is bounded by Wilfred Avenue on the north, Stony Point Road on the east, Rohnert Park Expressway on the south and residential/commercial/agricultural development on the east. The site boundaries are depicted on the *Site Plan/Geologic Map*, Figure 2 in Appendix A. The site is currently being utilized for agricultural purposes. It is understood that the northern portion of the site is currently being irrigated with reclaimed water and is routinely harvested for hay crops.

The northwest portion of the site contains a barn structure and other outbuildings associated with the agricultural use of the site. The southern portion of the site is bordered by the Laguna de Santa Rosa, which has been graded into a trapezoidal flood control channel. The site is also traversed by a northeast-southwest trending flood control channel (Bellevue-Wilfred Channel) which drains into the Laguna de Santa Rosa. The estimated depth of the Bellevue-Wilfred Channel is approximately 12 to 15 feet below the adjacent agricultural land.

Based on our literature and aerial photograph review, an unnamed creek previously traversed north/south across the site and intersected the Laguna de Santa Rosa east of present-day Stony Point Road. Remnants of this creek exists onsite today, but water is now channeled through the site via the Bellevue-Wilfred Channel. The Laguna de Santa Rosa has also been partially realigned from its original alignment. The approximate former natural alignments of the unnamed creek and the Laguna de Santa Rosa are depicted on the *Site Plan/Geologic Map*, Figure 2 in Appendix A.

Topographically, the site is essentially flat and level with the exception of the depressed flood control drainage channels. The site is located within the lowest portion of the Santa Rosa Plain (a.k.a. the Cotati Valley). The elevation across the site is approximately 90 feet above Mean Sea Level (MSL).

Based on the Federal Emergency Management Agency (FEMA) Flood Insurance Rate Map, the majority of the site is within the 100-year flood zone (1% annual chance of flooding). The northeastern part of the site is within the 500-year flood zone (0.2% annual chance of flooding). The northwest portion of the site is not within either the 100-year or 500-year flood zone.

### 2.2 Project Description

Specific details of the proposed project have not yet been determined. However, current conceptual plans call for an approximately 100-acre casino complex including a 600,000 square foot hotel-casino, a multilevel parking structure and additional at-grade parking areas. The casino will likely be multi-



story with architectural features that may require large spans. The hotel portion of the development is expected to be multi-story, as much as a ten-story structure. Therefore, we anticipate that foundation loads will be in the moderate to high range, depending on the final configuration of the development. The multilevel parking structure will likely be a cast-in-place, reinforced concrete structure. Access roads and at-grade parking areas will likely consist of asphalt concrete pavement overlying compacted aggregate base material.

Site development will also include onsite water and wastewater treatment facilities. The details and layout of these facilities are currently being developed. Domestic water facilities may include onsite wells, treatment and storage facilities (tanks). Wastewater treatment/disposal facilities may include a treatment plant, detention basins and/or spray irrigation fields.

DRAFT

### 3.0 SOIL AND GEOLOGIC CONDITIONS

Soil and geologic conditions were identified by observation of exploratory excavations; geologic mapping, interpretation of stereo aerial photographs and a review of published geologic literature (see *List of References*, Section 7.0 of this report).

Sonoma County lies within the Coast Ranges Geomorphic Province. This region is characterized by northwest-trending mountains and valleys. The site, located in central Sonoma County, lies within the Santa Rosa Plain (also known as the Cotati Valley). The Cotati Valley is situated between the Mendocino Range on the west and the Mayacamas and Sonoma mountains to the east. The valley is characterized by sediments deposited by streams on floodplains, alluvial deposits and basins. The valley is part of the Russian River watershed which drains to the Pacific Ocean, approximately 15 miles west of the site. Sedimentary rocks of the Petaluma Formation and Sonoma group volcanics constitutes the basement rock underlying the several hundred feet of Quaternary age alluvial sediments.

The site is underlain by Quaternary-aged alluvial soil deposits derived from the surrounding highlands. The alluvial material observed at the site was (and is) derived from adjacent formational units. The alluvium at the site is subdivided into three alluvial subunits: Basin Deposits (Qb), Fluvial Deposits (Qyfo) and alluvial fan deposits (Qof). The general soil types within the subunits are similar; however, there are differences that may affect the engineering properties of the soil. Detailed descriptions are presented in the following sections. The approximate lateral extents of the alluvial subunits are depicted on the *Site Plan/Geologic Map*, Figure 2 in Appendix A.

#### 3.1 Basin Deposits (Qb)

The interfluvial basin deposits are primarily located east of the Bellevue-Wilfred channel (see *Site Plan/Geologic Map*, Figure 2 in Appendix A). These young, marsh-like basin deposits are primarily comprised of interbedded lenses of dark brown silty clay with zones of sandy, silty clay and clayey sand. Although not encountered during our investigation, zones of organic material (decaying plant matter) may also be present within these materials. In general, the consistency of the clay material ranges from stiff to very stiff. The basin deposits are blanketed by a layer of highly expansive clay. The thickness of this clay layer ranges from approximately two to five feet, beginning at the ground surface. Desiccation cracks on the order of ½-inch to 1-½ inches wide were observed at the ground surface within this material at the time of our field investigation (September 2003). In general, the engineering properties of this material are fair to good. However, if not mitigated, the highly expansive surficial soil may cause damage to structures and structural pavements founded in this material.

### 3.2 Fluvial Deposits (Qyfo)

The fluvial deposits at the site are primarily located in a thin band west of the Bellevue-Wilfred Channel, approximately coincident with a former meander of the drainage (see *Site Plan/Geologic Map*, Figure 2 in Appendix A). These deposits generally consist of interbedded lenses of silty clay, and clayey/silty sand. Similar to the basin deposits, a surficial layer of highly expansive clay exists within these deposits. The thickness of this clay layer is approximately four feet, beginning at the ground surface. Similar to the basin deposits, the engineering properties of this material are fair to good. However, if not mitigated, the highly expansive surficial soil may cause damage to structures and structural pavements founded in this material.

### 3.3 Alluvial Fan Deposits (Qof)

The alluvial fan deposits at the site are located west of the fluvial and basin deposits, extending to the west boundary of the site (see *Site Plan/Geologic Map*, Figure 2 in Appendix A). These older alluvial deposits generally consist of clay-rich soils containing interbedded lenses clayey gravels, clayey sand and sandy clay. In general, the near surface clays are not as expansive (only low to medium expansion potential, based on UBC criteria) as those within the fluvial or basin deposits. The engineering properties of this material are generally good.

### 3.4 Groundwater

Groundwater was observed in several of the exploratory excavations during site investigative activities. Groundwater was encountered between 11 and 19 feet below the ground surface during our investigation (September 2003).

Based on the referenced literature reviewed, data from the USGS indicate that groundwater in the Cotati Valley was historically encountered 5 to 20 feet below ground surface. Groundwater data on file with the Sonoma County Environmental Health Division for an adjacent property located at 5307 Stony Point Road provides an indication of local shallow groundwater characteristics. Data collected within shallow monitoring wells at the property between November 2000 and March 2003 indicate that water levels vary seasonally, with depth to water ranging from approximately 3.6 feet below ground surface in March 2003, toward the end of the rainy season, to approximately 8.5 feet below the ground surface in September, prior to the onset of the rainy season.

It must be noted that fluctuations in the level of groundwater may occur due to variations in rainfall, temperature, and other factors. Therefore, it is possible that groundwater may be higher or lower than the levels observed during our investigative activities.

## 4.0 GEOLOGIC HAZARDS

Several geologic hazards may potentially affect the site. Table 4.0 provides a list of the potential geologic hazards associated with the site. Discussion of the items presented in Table 4.0 is included in the following sections.

TABLE 4.0  
SUMMARY OF POTENTIAL GEOLOGIC HAZARDS

Seismic Impacts – Faulting, Liquefaction, Lateral Spreading, Seismic-Induced Flooding
Expansive Soil
Corrosive Soil
Regional Subsidence
Flooding

### 4.1 Faulting and Seismicity

The project site is within the seismically active San Francisco Bay Area and moderate to severe ground shaking is probable during the anticipated life of future development. Based on our analyses, no active or potentially active faults are known to cross the site and the potential for ground surface rupture is low. In addition, the site is not contained within a Special Studies Earthquake Fault Zone (formerly referred to as an Aliquist-Priolo Special Studies Zone). Potential secondary seismic impacts are described in the following sections.

#### 4.1.1 Deterministic Analysis

The site is located in a seismically active region, and as such, strong ground shaking would be expected during the lifetime of any construction projects. Ground shaking at the site could damage buildings and other structures and pose a threat to occupants.

In order to determine the distance of known “active” and “potentially active” faults to the site, we reviewed available seismic/geologic literature (see *List of References*, Section 7.0 of this report) and utilized the computer program EQFAULT, Version 3.00 (Blake, 1988, updated 1999) was utilized. A search radius of 62 miles (100 kilometers) was performed and the ten closest known active faults were identified. Principal references used within EQFAULT in selecting faults to be included were Jennings (1975), Anderson (1984) and Wesnousky (1986). In addition to fault location, EQFAULT was used to deterministically estimate ground accelerations at the site. Attenuation relationships presented by Sadigh et al. (1997) were used to estimate site accelerations.

The closest active fault to the site is the Rodgers Creek Fault, located approximately 4.8 miles east of the site. The Rodgers Creek Fault has a Maximum Considered Earthquake (MCE) moment magnitude ( $M_w$ ) of 7.0. This fault is considered to be the source of the greatest seismic ground shaking at the site.

The MCE is defined as the maximum earthquake that appears capable under the presently known tectonic framework.

Figure 3 in Appendix A, depicts the major regional faults in the vicinity of the site. Table 4.1 presents a summary of the significant active faults identified, their distance from the site, and a summary of potential ground accelerations associated with the MCE for each fault. The information presented on Table 4.1 was derived from the seismic analyses utilizing EQFAULT with attenuation relationships by Sadigh et al (1997) used to estimate the peak site accelerations.

**TABLE 4.1  
DETERMINISTIC SITE PARAMETERS**

Fault Name	Approximate Distance from Site (miles)	Maximum Considered Earthquake Moment Magnitude ( $M_w$ )	Maximum Credible Peak Site Acceleration (g)
Rodgers Creek	4.8	7.0	0.36
San Andreas	14.9	7.9	0.26
Maacama	15.0	6.9	0.17
West Napa	20.3	6.5	0.10
Point Reyes	25.1	6.8	0.12
Hayward	27.8	7.1	0.10
Hunting Creek - Berryessa	29.1	6.9	0.09
Collayomi	29.1	6.1	0.06
Concord - Green Valley	30.0	6.9	0.08
San Gregorio	32.4	7.3	0.10

While a listing of peak accelerations is useful for comparison of potential effects of fault activity in a region, other considerations are important in seismic design, including the frequency and duration of motion and the soil conditions underlying the site.

#### **4.1.2 Probabilistic Seismic Hazard Analysis**

The computer program FRISKSP (Blake, 1995, updated 1998) was used to perform a site-specific probabilistic seismic hazard analysis. The program is a modified version of FRISK (McGuire, 1978) that models faults as lines to evaluate site-specific probabilities of exceedance of given horizontal accelerations for each line source. Geologic parameters not included in the deterministic analysis are included in this analysis. The program operates with the assumption that the occurrence rate of earthquakes on each mappable Quaternary fault is proportional to the slip rate of the fault. Fault rupture

length as a function of earthquake magnitude is considered, and estimates of site acceleration are made using the earthquake magnitude and closest distance from the site to the rupture zone.

Uncertainty is accounted for in each of following: (1) earthquake magnitude, (2) rupture length for a given magnitude, (3) location of the rupture zone, (4) maximum possible magnitude of a given earthquake, and (5) acceleration at the site from a given earthquake along each fault. By calculating the expected accelerations from all earthquake sources, the program calculates the total average annual expected number of occurrences of a site acceleration greater than a specified value. Attenuation relationships suggested by Sadigh, et al., (1997) were utilized in the analysis.

The results of the analysis indicate the following:

- Upper Bound Earthquake ground motion: 0.55g
- Design-Basis Earthquake ground motion: 0.45g

The Upper Bound Earthquake (UBE) is defined in the 1998 CBC, Chapter 16, as the ground motion with a 10% chance of exceedance in 100 years. This value corresponds to a return period of approximately 1000 years (actual statistical return period = 949 years). The Design Basis Earthquake (DBE) is defined as the ground motion with a 10% chance of exceedance in 50 years. This value corresponds to a return period of approximately 475 years (actual statistical return period = 474.6 years).

#### **4.1.3 Liquefaction**

Soil liquefaction is a condition where saturated granular soils near the ground surface undergo a substantial loss of strength during seismic events. Primary consequences of liquefaction include ground surface deformations (sand boils) and ground surface settlement. Soils most susceptible to liquefaction are loose, uniformly-graded sand and loose silts with low cohesion.

Based on the referenced literature reviewed, the potential for liquefaction in the vicinity of the site varies from very low to high. Based on liquefaction susceptibility maps prepared for the City of Rohnert Park by William Lettis & Associates in 1994 (see *List of References*, Section 7.0), the liquefaction potential at the site ranges from very low to moderate/high. An adaptation of the liquefaction susceptibility map prepared by Lettis & Associates is presented as Figure 4 in Appendix A. The liquefaction susceptibility rating depicted on the Lettis & Associates map is based on general geologic conditions, rather than site-specific conditions and, in at least one case, they are inconsistent with site-specific geotechnical studies. A geotechnical study for the adjacent Rancho Feliz Mobile Home Park prepared in 1996, indicates that the liquefaction potential is very low. The mobile home park is located within a "moderate to high" liquefaction zone on the Lettis & Associates Map.

The subsurface conditions observed during our field investigation at the site consist of interbedded layers of primarily clay-rich soils. The site is blanketed with a layer of lean to fat clay. Some

discontinuous zones of loose to medium dense, clayey sand were encountered below the groundwater table at different depths in the exploratory borings. However, laboratory testing of these clayey sands indicates that the fines content (portion of material finer than the No. 200 sieve) are generally 30% or higher. Based on the regional soil types, the majority of fines are typically clay rather than silt. It is widely accepted that materials with clay content greater than 20% is not considered liquefiable (Modified "Chinese Criteria", after Finn et al, 1994). Additionally, research presented by Isihara (1985) indicates that the presence of a non-liquefiable surface layer may prevent the effects of at-depth liquefaction from reaching the surface.

Based on the above discussion, the potential for liquefaction at the site cannot be completely ruled out. Our initial investigative effort is based on exploration points on a relatively large spacing. Therefore, the likelihood of variation of subsurface materials between these exploration points is proportionally higher. Zones of potentially liquefiable materials may be randomly distributed across the site. Future design-level geotechnical studies should be conducted to evaluate the potential for liquefaction within the footprints of structural improvements (once determined).

Where the design-level geotechnical study indicates that conditions are present that could result in liquefaction and subsequent damage to structural improvements, appropriate feasible mitigation measures should be developed and incorporated into the project design. Such mitigation measures may include:

- Deep foundation systems extending beyond the liquefiable layers
- Shallow foundation systems reinforced to withstand differential movement
- Soil improvement methods: densification, dewatering or removal and replacement

#### **4.1.4 Lateral Spreading**

Lateral spreading during a seismic event typically occurs as a form of horizontal displacement of relatively flat-lying alluvial or sediment deposits toward an open or "free" face such as an open body of water, channel or excavation. Generally, in soils this movement is due to failure along a weak plane, formed within an underlying liquefied layer. As cracks develop within the weakened material, blocks of soil displace laterally towards the free face. Subsurface conditions indicate that potentially liquefiable sand layers beneath the site are non-existent or isolated; therefore, the potential for lateral spreading is low.

#### **4.1.5 Seismically Induced Flooding**

The project area is well protected by distance and topography from tsunami (a great sea wave produced by a submarine earthquake) emanating from the Pacific Ocean. The site is not located downstream of any major dams that could inundate the site as a result of seismic-induced failure.

#### 4.2 Slope Stability, Landslides

With the exception of the side slopes of the Bellevue-Wilfred Channel, the site is essentially flat and level. The site is not located adjacent to sloping ground that may be subject to slope instability or landslides. Development practices will likely require a minimum development setback from the Bellevue-Wilfred Channel. Therefore, the potential for damage to development due to slope instability is low.

#### 4.3 Expansive Soil

Expansive soils are present across the surface of the site. Based on UBC criteria, the expansion rating of near-surface soil varies from "very low" to "very high" across the site. The UBC expansion rating for surface samples obtained near the exploratory borings are depicted on the *Site Plan/Geologic Map*, Figure 2 in Appendix A. In general, the near-surface soil conditions are more expansive east of the Bellevue-Wilfred Channel. If unmitigated, expansive soils subjected to seasonal moisture variations may cause damage to overlying structures or shallow utilities. Specific mitigation measures for expansive soils should be a part of future design level geotechnical studies at the site.

#### 4.4 Soil Corrosivity

One of the three soil samples submitted for corrosion potential testing exhibited a low resistivity (high conductivity). Therefore, the soil may be considered mildly corrosive to concrete or steel. If corrosion-sensitive improvements are planned, consultation with a corrosion engineer is recommended.

#### 4.5 Subsidence

The Rohnert Park/Cotati Valley area of Sonoma County is a large alluvial valley with significant groundwater storage. As such, numerous groundwater extraction wells are located within the Cotati Valley for domestic use. Continued groundwater withdrawal with limited recharge causes land mass subsidence, resulting in the lowering of the ground surface elevation. Because any subsidence in the Cotati Valley would be regional, unlike local differential settlement, it would not likely have a significant effect on proposed building foundations at the project site or storm/sewer facilities (or other utilities) that rely on gravity-driven flow.

#### 4.6 Flooding

Based on the Flood Insurance Rate Maps (FIRM) prepared by the Federal Emergency Management Agency (FEMA), the majority of the site is contained within 100-year or 500-year flood zones. The exception is approximately 35 acres located in the northwest portion of the site. The approximate flood zone designations are depicted on the FEMA Flood Zone Map, Figure 5 in Appendix A.



## 5.0 CONCLUSIONS AND RECOMMENDATIONS

### 5.1 General

In our opinion, the soil and geologic conditions at the site do not preclude development of the project as conceptually proposed, provided appropriate design measures are implemented to mitigate the geotechnical difficulties at the site. The primary geotechnical concern at the site is the presence of highly expansive soil conditions, which can lead to grading, foundation and pavement difficulties. A secondary concern is the possibility isolated zones of potentially liquefiable soil at random locations throughout the site. Liquefaction of these zones may cause differential settlement of structures founded above this material. Both concerns may be mitigated with appropriate engineering design.

Table 5.1 presents a summary of the anticipated geotechnical conditions that may impact development on the project.

**TABLE 5.1  
PRIMARY GEOTECHNICAL CONDITIONS**

Development Consideration	Geotechnical Conditions
Grading - Earthwork	Easy excavation characteristics Difficult clay soils for construction Moderate to extensive site preparation
Foundations	Expansive soil conditions Slight potential for isolated liquefaction Moderate (typical) allowable bearing capacities Shallow or intermediate foundation systems suitable for light structures Deep foundation systems for heavily-loaded structures Low to moderate soil corrosion potential
Underground Utilities	Easy excavation characteristics Stable trench walls above groundwater table Dewatering required below groundwater table Low to moderate soil corrosion potential
Pavement	Unstable/pumping subgrade Expansive soil conditions Thicker sections required

The following sections provide specific discussion of the various areas of site development that may be impacted by the geological/geotechnical conditions present at the site. These conclusions are preliminary in nature and are intended for planning purposes. Detailed recommendations can be provided in future geotechnical studies which would be based upon specific site development plans and more detailed geotechnical information obtained from subsurface studies.

## 5.2 Grading – Earthwork

Table 5.2, below, summarizes the primary conditions expected during site grading.

**TABLE 5.2  
ANTICIPATED GRADING CONDITIONS**

Easy excavation characteristics Moderate site preparation Difficult clay soils for construction Import fill soil required
--

Detailed descriptions of the conditions listed above are discussed below:

- The entire site is underlain by alluvial materials blanketed by a layer of moderately to highly expansive clay. In our opinion, grading and excavations at the site may be accomplished with light to moderate effort with conventional heavy-duty grading/excavation equipment. Excavations are not anticipated to generate oversized material (greater than six inches in dimension) or boulders that would require special handling or exporting from the site.
- Depending on the location of the planned improvements, extensive site preparation may be necessary. The site is currently being irrigated with reclaimed water and grazed by cattle. These agricultural practices have resulted in low lying depressions containing very soft, organic-rich soil. In addition, remnants of the former natural creek alignment are still present at the site. Prior to grading, some of these areas may need to be cleared and the unstable (soft, wet, organic) soil removed. Removals may extend on the order of four to six feet below the ground surface in some areas.
- Due to the high moisture content of much of the near-surface soils, construction of engineered fills will be challenging. Establishing a firm base for constructing fills will likely be very difficult in some areas, depending on the specific conditions. Pumping, unstable subgrade conditions may be quite common when trying to establish a firm base for building pads or roadways. Stabilization techniques such as bridging with geotextiles or aggregate or the use of lime treatment may be required.
- The near-surface clay soils are moderately to highly expansive across the site. The presence of highly expansive soil and its ability to absorb moisture and soften can impact grading costs especially if grading is conducted in the winter and early spring months. Rainfall and wet soil conditions may prohibit efficient grading and limit productive earth moving to the drier portions of the year.
- Groundwater is not anticipated to significantly affect grading operations if conducted during the summer and/or fall seasons (dry season). However, groundwater and soil moisture

conditions could be significantly different during the winter and spring seasons. Grading during this time period will likely encounter wet materials resulting in possible excavation and fill placement difficulties.

- Grading during the wet season may be accomplished by stabilizing the near-surface soils with lime. Additional benefits of lime-treatment include reducing expansion potential and increasing the pavement support characteristics of the soil. We anticipate that the site soils should react well with the addition of lime. Specific lime-treatment recommendations should be part of future studies for the site.
- Graded building pads that sit through a dry period without completion of the overlying structure may exhibit shrinkage cracks which may require heavy watering and/or presaturation to prepare the soil for concrete foundations and slabs on grade. Once buildings are in production, a method should be implemented to keep relatively moist soil conditions prior to foundation excavation and concrete placement.
- Due to the moderate to highly expansion potential of the near-surface native soil, it is possible that some of the native soils may be deemed unsuitable for use as engineered fill. Therefore, import fill soil may be required.

### 5.3 Foundations

The primary geotechnical difficulty affecting building foundations at the site is the potential for differential movement caused by expansive soil conditions. Another difficulty could be differential settlement caused by the liquefaction of underlying materials. Both of these difficulties may be mitigated within the design of the structural foundations.

Based on the conditions encountered during our investigation, the foundation types listed in Table 5.3 are considered feasible for development. One to three-story, framed structures, with typical foundation loading (1,500 pounds per lineal foot on the perimeter and up to 100 kips column loads) such as a casino or hotel, may be considered a light to moderately-loaded structure. Heavily loaded structures would include multi-story hotel structures exceeding approximately three stories in height and multistory parking garages. The foundation systems presented are for planning purposes only. Actual structural loading may dictate different systems or designs.

**TABLE 5.3  
FEASIBLE FOUNDATION SYSTEMS**

	Anticipated Feasible Foundation Systems
<b>Light to Moderately Loaded Structures</b>	Continuous strip footings with isolated interior footings tied with grade beams Post-tensioned concrete slab system/Structural mat slab
<b>Heavily Loaded Structures</b>	Drilled pier system Driven piles Post-tensioned concrete slab system/Structural mat slab Continuous strip footings with isolated interior footings tied with grade beams

- Site soils are considered capable of supporting light to moderately loaded structures on shallow foundation systems. Due to the presence of expansive soil at the site, shallow foundation systems should be designed to reduce the potential for significant seasonal moisture variation under buildings. This may be accomplished by providing continuous perimeter strip footings that extend below the depth of seasonal moisture variation (typically 18 inches or deeper). Additionally, the foundation elements may need to be reinforced heavier than typical design dictates.
- Alternatively, the shallow foundation system described above can be designed with interconnecting grade beams that would help the foundation system act as a unit rather than individual foundation components acting independently (such as isolated spread footings). This system would help mitigate differential movement caused by soil expansion or differential settlement caused by potential liquefaction.
- The use of a post-tensioned concrete tensioned slab or a more heavily-reinforced mat slab foundation would be another alternative foundation system. The concept would be to isolate the structure, or a portion of a structure, on the mat designed to act as a unit. This will reduce the potential for portions of the structure to move independently which may result in distress to the structure. These foundation systems would probably be more applicable to moderately loaded structures; however, if designed accordingly, they could be used for heavier structures.
- Heavily-loaded structures can be supported upon drilled piers which are expected to be relatively easy to drill to the required depths. Drill holes should stand open without significant caving. Drilled piers could be belled to provide additional downward capacity. Belled piers would also be efficient at providing uplift resistance, if required. The presence of groundwater may require casing or periodic pumping of drilled pier excavations but is not expected to be a significant item unless pier depths exceed 20 to 30 feet below the existing ground surface.
- Heavily-loaded structures can likely be supported on piles driven into the alluvium in the depth range of approximately 30 to 50 feet bgs. Pile driving conditions are anticipated to be favorable at the site. It is anticipated that tolerable settlement would result for piles loaded in the 45 to 70 Tons per pile range.
- Site soils may be slightly to moderately corrosive to regular concrete or steel. Further corrosion study, including consultation with a corrosion engineer, should be a part of future studies at the site.

## 5.4 Underground Utility Construction

The following conditions can be expected for underground utility construction:

**TABLE 5.4  
ANTICIPATED UNDERGROUND UTILITY CONSTRUCTION CONDITIONS**

Easy excavation characteristics  
Stable trench walls above groundwater table  
Dewatering required below groundwater table  
Low to moderate soil corrosion potential

- Trenching with conventional heavy duty excavation equipment is expected to be easy in terms of excavation difficulty. Trench sidewalls should stand near vertical to depths of at least five feet, provided it is above the groundwater table. Dewatering of trenches may be required if excavations extend a significant depth below the groundwater table.
- Some stabilization of trench bottoms may be required in order to achieve adequate bedding for gravity lines. This may be accomplished by placing coarse aggregates or geotextile fabrics or a combination of both. Specific recommendations should be part of the future design-level studies for the site.
- Backfilling trenches with the excavated soil may require significant drying or moisture conditioning to achieve suitable compaction. These operations may be difficult during the wet season. Alternatively, more suitable import material may be utilized as backfill.
- Site soils may be slightly to moderately corrosive to regular concrete or steel. Further corrosion study, including consultation with a corrosion engineer, should be a part of future studies at the site.

## 5.5 Pavement - Roadways

Table 5.6, below, summarizes the anticipated conditions at the site with respect to pavement design and roadways.

**TABLE 5.5  
GENERALIZED PAVEMENT CONSTRUCTION CONDITIONS**

Expansive soil conditions  
Unstable/Pumping subgrade conditions  
Thick pavement sections required

- Expansive soil conditions are the primary geotechnical difficulty with respect to pavement and roadway design and construction. Expansive soil conditions may be mitigated by removal and replacement with non-expansive material, lime-treatment, or design of pavement sections to withstand the potential swelling pressures caused by expansive soil.

- If the expansive soils are not stabilized, we recommend that pavements be limited to flexible pavement, such as asphalt concrete or interlocking paving stones. Rigid pavements, such as Portland cement concrete could be used; however, the probability of damage due to differential subgrade movement would be significantly higher than that for flexible paving.
- Establishing a firm base for pavement subgrades will likely be very difficult in some areas, depending on the specific conditions. Pumping, unstable subgrade conditions may be quite common when trying to establish a firm base for roadways. Stabilization techniques such as bridging with geotextiles or aggregate may be required.
- Due to the poor pavement support characteristics of the native clay soils, pavement sections will likely be very thick. To reduce overall pavement thicknesses, lime treatment of subgrade materials is recommended. Specific lime-treatment recommendations should be part of future studies for the site.

### 5.6 Design-Level Geotechnical Study

Prior to finalization of the grading and development plans for the project, a design-level geotechnical investigation addressing the specific grading, structural foundation and development plans should be performed. The design-level geotechnical study should include a detailed liquefaction analysis in areas planned for structural improvements; site-specific grading recommendations (including remedial grading and expansive soil mitigation), foundation type selection and geotechnical design parameters for all proposed structures.

## 6.0 LIMITATIONS AND UNIFORMITY OF CONDITIONS

The purpose of this geologic and geotechnical feasibility investigation was to identify the soil and geologic conditions at the site, determine the presence of geologic hazards and to provide preliminary geotechnical recommendations with respect to development of the proposed casino complex at the project site. Additional design-level studies, including additional subsurface exploration, laboratory testing and geotechnical engineering analysis will be required prior to development of the site improvement plans.

The recommendations of this report pertain only to the site investigated and are based upon the assumption that the soil conditions do not deviate from those disclosed in the investigation. If any variations or undesirable conditions are encountered during construction, or if the proposed construction will differ from that anticipated herein, Geocon should be notified so that supplemental recommendations can be given. The evaluation or identification of the potential presence of hazardous or corrosive materials was not part of the scope of services provided by Geocon.

This report is issued with the understanding that it is the responsibility of the owner, or of his representative, to ensure that the information and recommendations contained herein are brought to the attention of the architect and engineer for the project and incorporated into the plans, and the necessary steps are taken to see that the contractor and subcontractors carry out such recommendations in the field.

The findings of this report are valid as of the present date. However, changes in the conditions of a property can occur with the passage of time, whether they be due to natural processes or the works of man on this or adjacent properties. In addition, changes in applicable or appropriate standards may occur, whether they result from legislation or the broadening of knowledge. Accordingly, the findings of this report may be invalidated wholly or partially by changes outside our control. Therefore, this report is subject to review and should not be relied upon after a period of three years.

## 7.0 LIST OF REFERENCES

1. Dyett & Bhatia, *Rohnert Park General Plan, Revised Draft Environmental Impact Report*, State Clearinghouse No. 99062114. Prepared for the City of Rohnert Park Department of Planning and Community Development, May 2000.
2. The Huffman-Broadway Group, *Draft Phase I Environmental Site Assessment, 360-Acre Agricultural Property, Rohnert Park, California*, November 2003.
3. Huffman, M.E. and Armstrong, C.F., *Geology for Planning in Sonoma County*, including Greensfelder, R.W. *Seismicity, Ground Shaking and Liquefaction Potential*, California Division of Mines and Geology, dated 1980.
4. Jennings, C.W., *Fault Activity Map of California and Adjacent Areas*, California Division of Mines and Geology, dated 1994.
5. Parson, Harland, Bartholomew & Associates, *City of Rohnert Park, Wilfred/Dowdell Village Specific Plan, Draft Environmental Impact Report*, June 1, 1999.
6. State of California, Division of Mines and Geology, *Fault Evaluation Report FER-141, Rogers Creek*, September 27, 1982.
7. State of California, *Special Studies Zones, Cotati Quadrangle*, dated 1983.
8. United States Geological Survey, topographic map, Cotati, California Sheet (SW/4 Santa Rosa 15' Quadrangle) 1954 (photorevised 1980).
9. Youd, T.L. and Hoose, S.N., *Historic Ground Failures in Northern California Triggered by Earthquakes*, United States Geological Survey Professional Paper 993, dated 1978.



APPENDIX





LEGEND:

Project Site Boundary

Approximate Flood Zone Boundary

100-Year Flood Zone

500-Year Flood Zone

Aerial photography dated October, 2002



**GEOCON**  
CONSULTANTS, INC.  
3188 BULLY HILL WAY, SUITE 805 - FANBURO, CA 95742  
PHONE: 916 837 9110 FAX: 916 837 9127

Station Casinos Project "G"  
Rohnert Park  
Sonoma County, California

**FEMA FLOOD ZONE MAP**

58689-08-02 January 2004

Figure 5

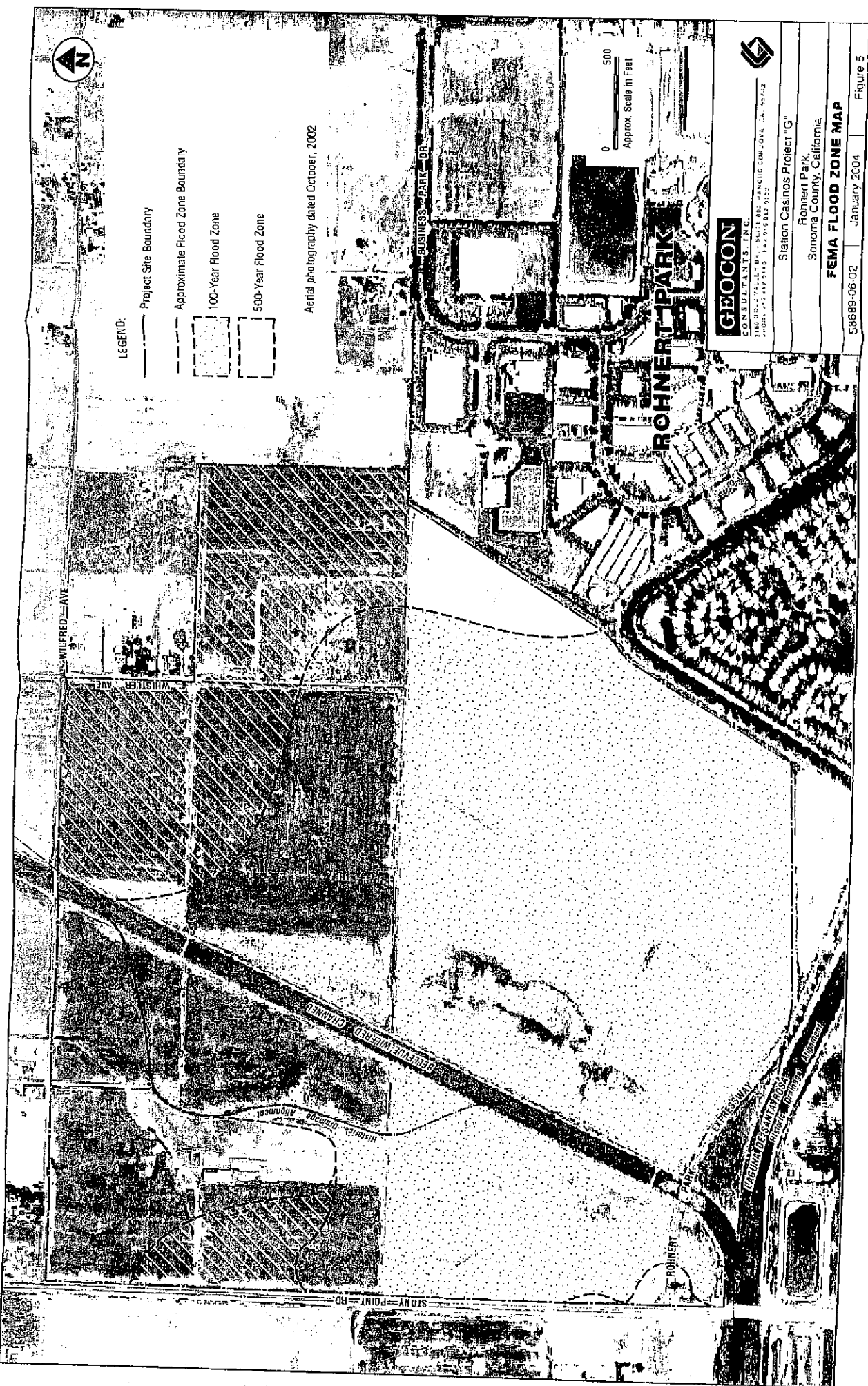



LEGEND:

Project Site Boundary

Approximate Liquefaction Susceptibility Boundary

VL Very Low

M-H Moderate to High

Source: William Lettis & Associates, 1994. Maps showing Quaternary Geology and Liquefaction Susceptibility in the Napa, California, 1:100,000 Sheet

Aerial photography dated October, 2002

0 500  
Approx. Scale in Feet

**GEOCON**  
CONSULTANTS, INC.  
2182 COLLEGE VALLEY DRIVE, SUITE 105  
NAPA, CALIFORNIA 94558-1112  
PHONE 707/252-0110 FAX 707/252-0172

Station Casinos Project "G"  
Rohnert Park  
Sonoma County, California

**LIQUEFACTION SUSCEPTIBILITY MAP**

S8689-05-02 January 2004

Figure 4

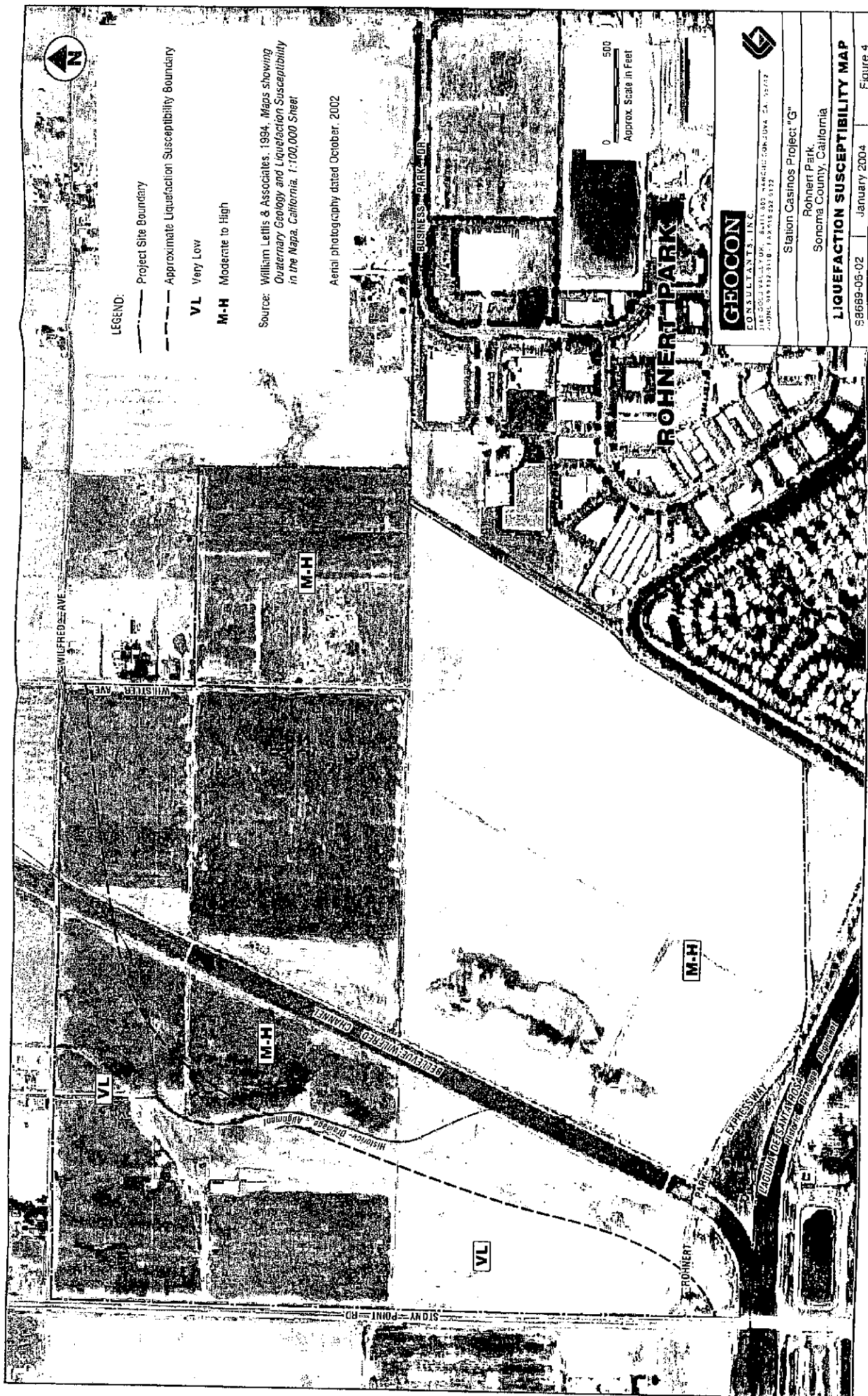

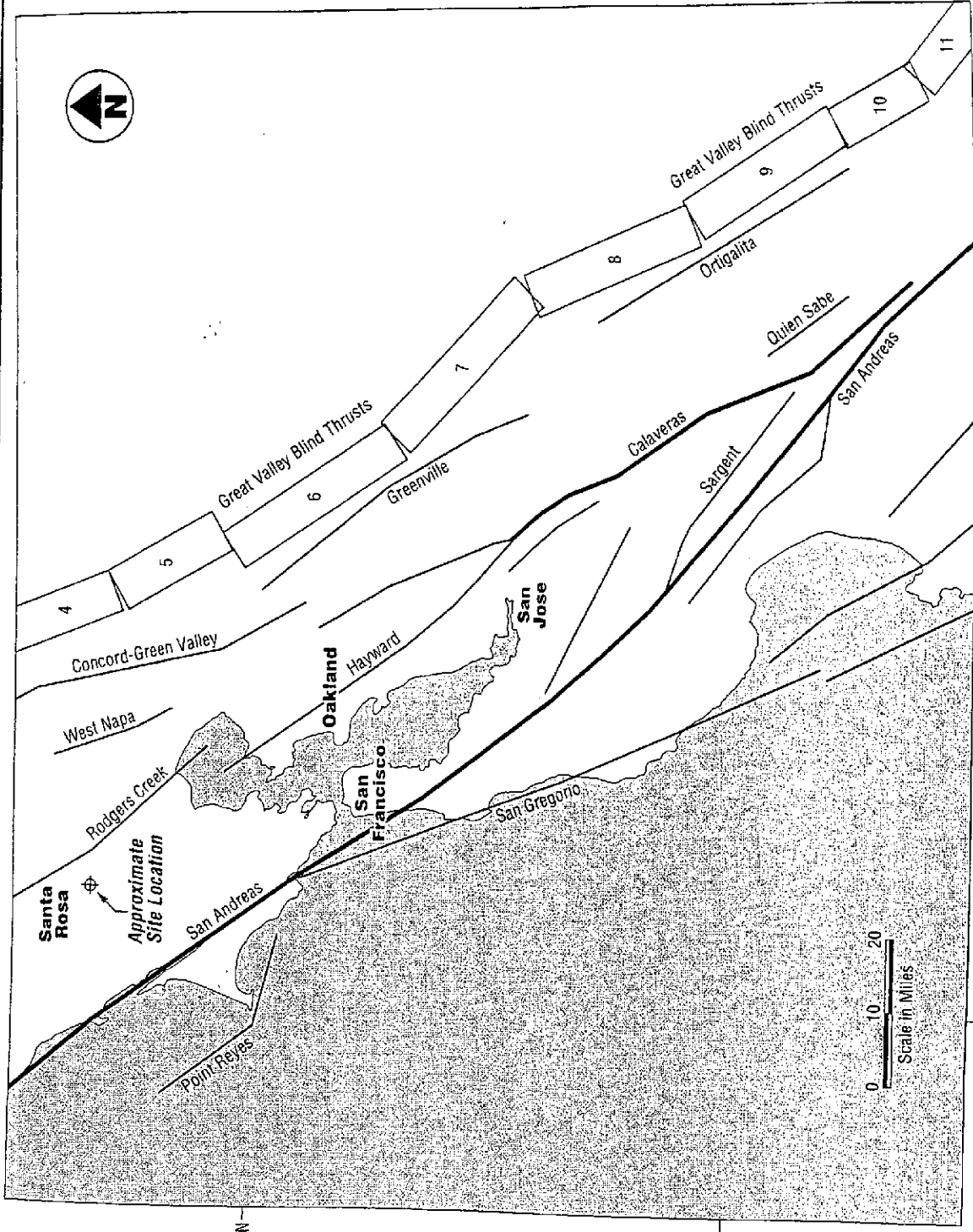

**GEOCON**  
 CONSULTANTS, INC.  
 3160 GOLD VALLEY DR. - SUITE 800 - RANCHO CORDOVA, CA. 95742  
 PHONE 916 852-9118 - FAX 916 852-9132



**REGIONAL FAULT MAP**

Station Casinos Project "G"

Rohnert Park,  
 Sonoma County, California

S8689-06-02

January 2004

Figure 3



LEGEND:

- Project Site Boundary
- ⊙ B1⊙ Approximate Exploratory Boring Location
- ⊙ CPT-1⊙ Approximate Cone Penetration Test Sounding Location
- - - Approximate Geologic Contact
- Qb Interfluvial marsh-like basin deposits; mainly poorly sorted dark clay & silty clay, both rich in organic matter
- Qyo Fluvial deposits at the outer edge of alluvial fans (Qyf); forms levees between basin deposits (Qb); characterized by fine, but variable, grain size; composed mainly of fine sand, silt & silty clay
- Qof Alluvial fan deposits bordering uplands; clay-rich soils containing lenses of deeply weathered, poorly sorted, coarse sand & gravel
- HIGH UBC Soil Expansion Rating

Aerial photography dated October, 2002

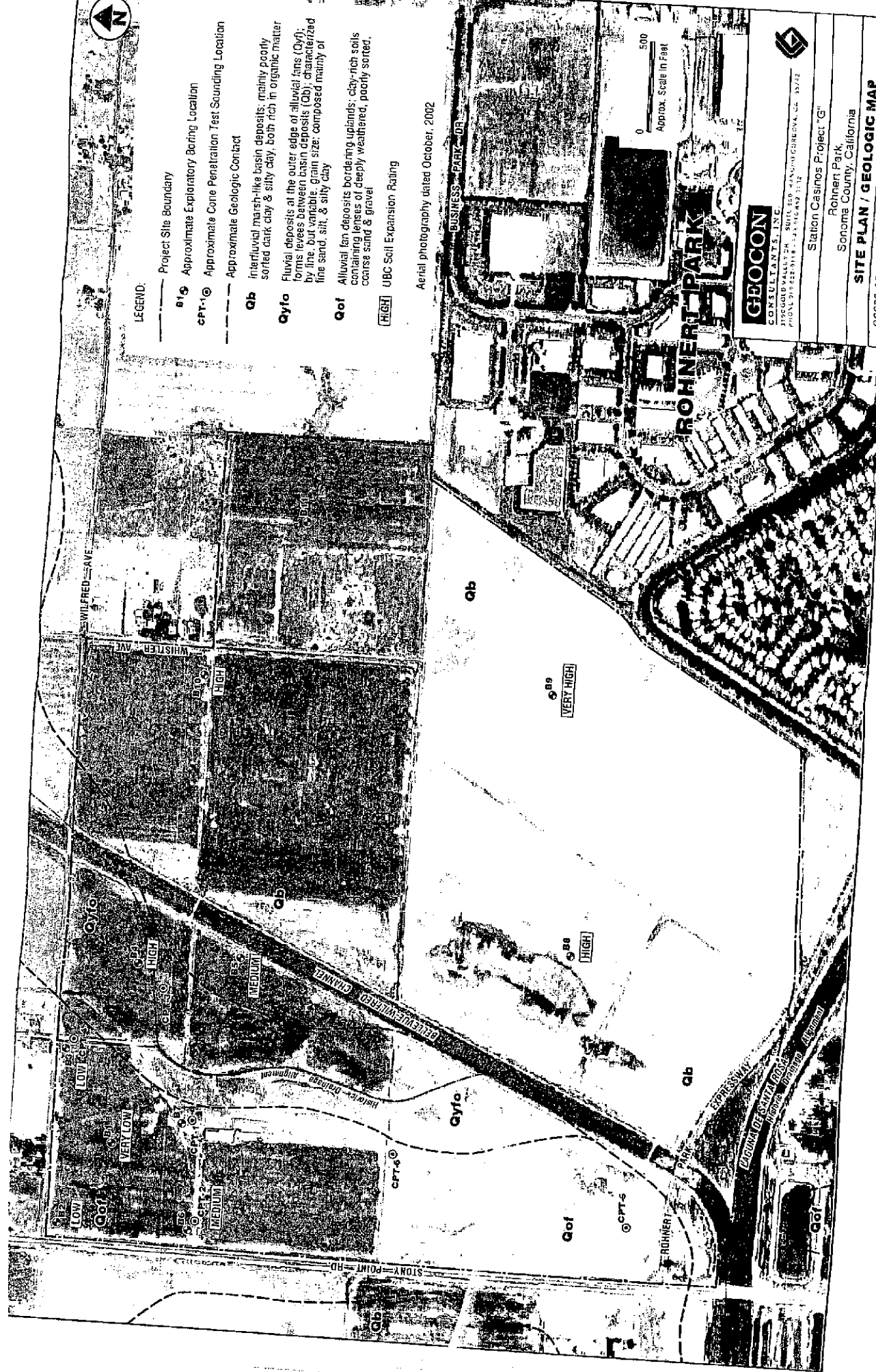

**GEOCON**  
 CONSULTANTS, INC.  
 1150 GOLD VALLEY DR. SUITE 100, SAN FRANCISCO, CALIFORNIA, CA 94132  
 PH: 415-424-7918 FAX: 415-424-7132

Station Casinos Project "G"  
 Rohnert Park,  
 Sonoma County, California

**SITE PLAN / GEOLOGIC MAP**

S86689-06-02 January 2004

Figure 2

APPENDIX A  
MAPS AND ILLUSTRATIONS

DRAFT

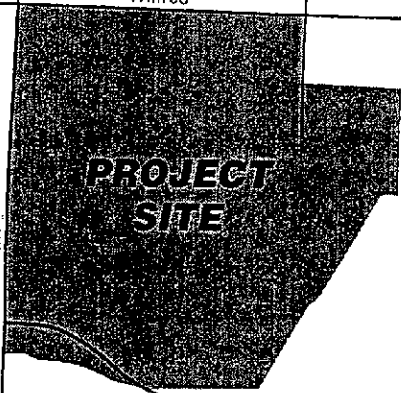

101

Horn Ave.

Millbrae Ave.

Rd.

Whistler Ave.

Wilfred Ave.

Mountain Shadows Golf Course

Point

**PROJECT SITE**

Business Park Dr.

Golf Course Dr.

Mountain Shadows Golf Course

Labath Ave.

Rohnert Park Stadium

101

Blvd.

Rohnert

Park

Expwy.

Stony

Lowell Ave.

**ROHNERT PARK**

Helman

Redwood

Commerce

116

Arlen Dr.

Adrian

Bivd.

Ln.

Southwest

Gravenstein

Hwy.

116

101

Old Redwood Hwy.

Cotati

Ave.

**GEOCON**

CONSULTANTS, INC.

3160 GOLD VALLEY DR. - SUITE 800 - RANCHO CORDOVA, CA. 95742  
PHONE 916 852-9118 - FAX 916 852-9132



0  1/2  
Scale in Miles

Station Casinos Project "G"

Rohnert Park,  
Sonoma County, California

**VICINITY MAP**

S8689-06-02

January 2004

Figure 1

APPENDIX

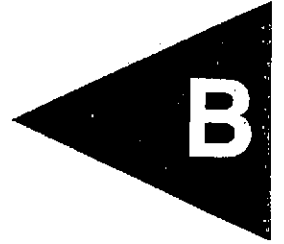



## APPENDIX B

### FIELD INVESTIGATION

The field investigation was performed during the period of September 10 through September 19, 2003. The field investigation consisted of the excavation of 11 exploratory borings (B1 through B11), and 6 Cone Penetration Test (CPT) soundings (CPT1 through CPT6) at the approximate locations shown on Figure 2.

The exploratory borings were excavated using a CME 75 truck-mounted drill rig using 8-inch diameter hollow-stem augers. Sampling was accomplished using an automatic 140-pound hammer with a 30-inch drop. Samples were obtained with a three-inch outside diameter split spoon sampler (California Modified Sampler). The number of blows required to drive the California Modified sampler the last 12 inches of the 18-inch sampling interval were recorded on the boring logs. The blow counts presented on the logs have been correlated to equivalent Standard Penetration Test (SPT) blow counts. Upon completion, the borings were backfilled with grout in accordance with Sonoma County Permit and Resource Management requirements.







The soil conditions encountered in the trenches and borings were visually examined, classified, and logged in general accordance with the American Society for Testing and Materials (ASTM) Practice for Description and Identification of Soils (Visual - Manual Procedure D2488-90). The logs of the exploratory borings are presented in Appendix B, Figures B1 through B13.

The CPT soundings were advanced using a 20-ton Cone Penetration rig. CPT parameters including tip resistance ( $q_c$ ), sleeve friction ( $f_s$ ) and dynamic pore pressure ( $U$ ) were measured at 5-cm intervals as the cone was advanced. Incorporating this data with the Robertson and Campanella (1988) method, soil behavior types were obtained, thus estimating the subsurface geologic conditions. Logs of the CPT soundings are included in this appendix.

DEPTH IN FEET	SAMPLE NO.	LITHOLOGY	GROUNDWATER	BORING B1		PENETRATION RESISTANCE (BLOWS/FT)	DRY DENSITY (P.C.F.)	MOISTURE CONTENT (%)
				ELEV. (MSL.)	DATE COMPLETED			
					NA	9/10/03		
					EQUIPMENT	CME 75		
MATERIAL DESCRIPTION								
0				CL	ALLUVIUM Soft, moist, light brownish gray (2.5Y 6/2), Silty CLAY - Stiff, damp - very stiff, EI= 18 (very low)			
2	B1-2.5 B1-3			SC	Very dense, damp, light olive brown (2.5Y 5/4), Clayey SAND with gravel	50	110.1	9.3
4								
6	B1-5.5 B1-6				- very moist	48	124.2	12.2
8								
10	B1-10.5 B1-11			CL	Stiff, moist, grayish brown (2.5Y 5/2), lean CLAY with sand			
12				CL	Very stiff, moist, pale yellow (2.5Y 7/3), Sandy CLAY	16	102.6	24.2
14								
16	B1-15.5 B1-16			CH	Very stiff, moist to wet, olive gray (5Y 4/2), fat CLAY, some rootlets	21	98.5	26.2
BORING TERMINATED AT 16.5 FEET								

Figure B1, Log of Boring B1, page 1 of 1

GEO\_NO\_WELL PROJ.GPJ 10/01/03

SAMPLE SYMBOLS	
	... SAMPLING UNSUCCESSFUL
	... STANDARD PENETRATION TEST
	... DISTURBED OR BAG SAMPLE
	... CHUNK SAMPLE
	... WATER TABLE OR SEEPAGE
	... DRIVE SAMPLE (UNDISTURBED)

NOTE: THE LOG OF SUBSURFACE CONDITIONS SHOWN HEREON APPLIES ONLY AT THE SPECIFIC BORING OR TRENCH LOCATION AND AT THE DATE INDICATED. IT IS NOT WARRANTED TO BE REPRESENTATIVE OF SUBSURFACE CONDITIONS AT OTHER LOCATIONS AND TIMES. ALL BLOW COUNTS HAVE BEEN CONVERTED TO EQUIVALENT STANDARD PENETRATION TEST (SPT) BLOW COUNTS

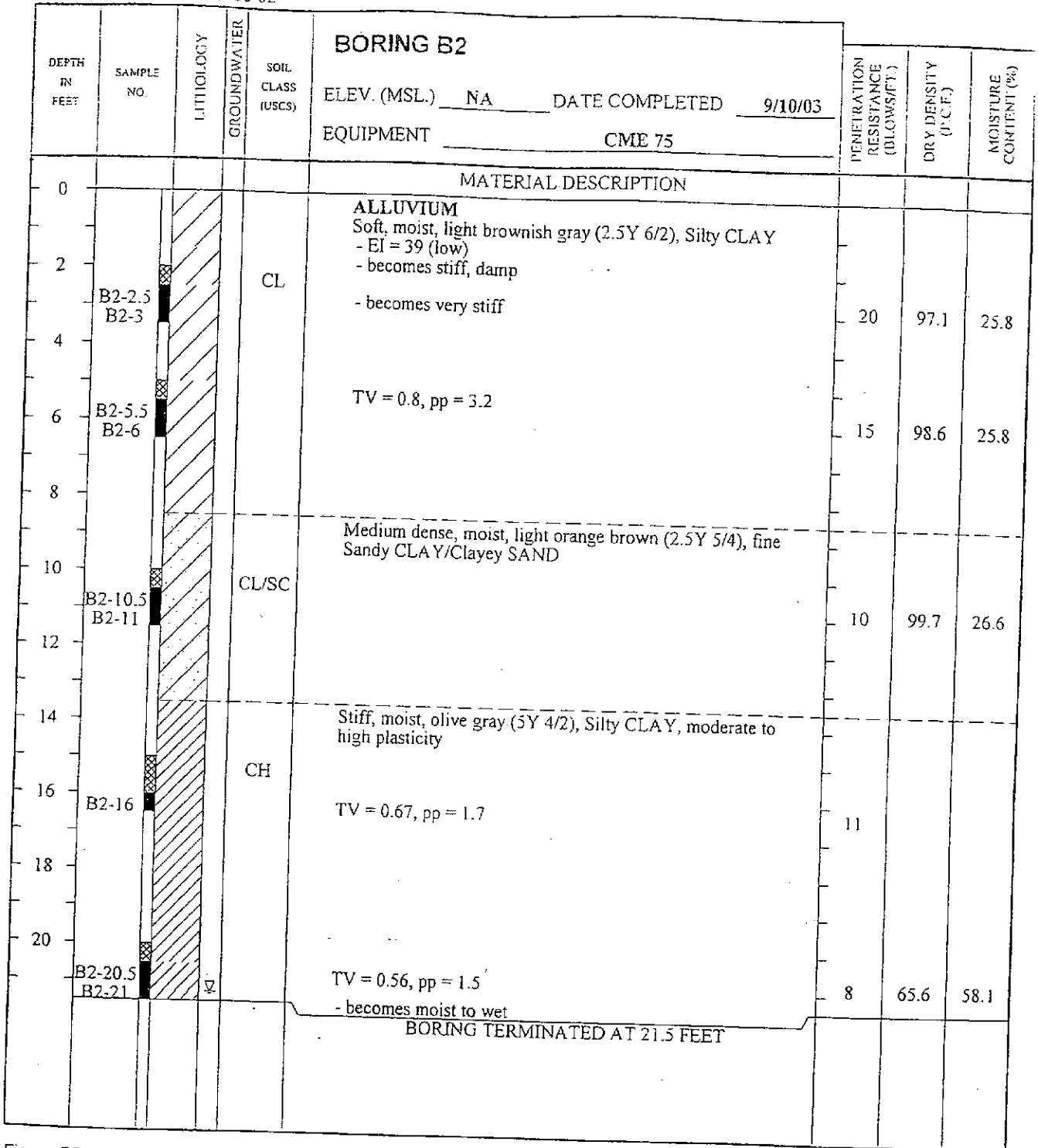







Figure B2, Log of Boring B2, page 1 of 1

GEO\_NO\_WELL PROJ.GPI 1001/03







SAMPLE SYMBOLS		
	... SAMPLING UNSUCCESSFUL	
	... DISTURBED OR BAG SAMPLE	
		
		
		... STANDARD PENETRATION TEST
		... DRIVE SAMPLE (UNDISTURBED)
		... CHUNK SAMPLE
		... WATER TABLE OR SEEPAGE

NOTE: THE LOG OF SUBSURFACE CONDITIONS SHOWN HEREON APPLIES ONLY AT THE SPECIFIC BORING OR TRENCH LOCATION AND AT THE DATE INDICATED. IT IS NOT WARRANTED TO BE REPRESENTATIVE OF SUBSURFACE CONDITIONS AT OTHER LOCATIONS AND TIMES. ALL BLOW COUNTS HAVE BEEN CONVERTED TO EQUIVALENT STANDARD PENETRATION TEST (SPT) BLOW COUNTS.

DEPTH IN FEET	SAMPLE NO.	LITHOLOGY	GROUNDWATER	SOIL CLASS (USCS)	BORING B3		PENETRATION RESISTANCE (BLOWS/FT.)	DRY DENSITY (P.C.F.)	MOISTURE CONTENT (%)
					ELEV. (MSL.)	DATE COMPLETED			
					ELEV. (MSL.)	NA	DATE COMPLETED	9/10/03	
					EQUIPMENT	CME 75			
MATERIAL DESCRIPTION									
0					ALLUVIUM				
2	B3-3			CL	Soft, moist, light brownish gray (2.5Y 6/2), Silty CLAY, surface desiccation cracks 1/2" wide - becomes stiff, very silty - EI = 39 (low) TV = 6.5, pp = 1.5		12	97.3	25.8
6	B3-6				TV = 0.51, pp = 1.0		14	92.7	27.1
10	B3-10.5 B3-11			CL	Stiff to very stiff, very moist, olive gray (5Y 4/2), Sandy lean CLAY		10	97.4	27.6
16	B3-16.5 B3-17				- sand content decreases - very clayey		20	102.4	24.6
BORING TERMINATED AT 17.5 FEET									

Figure B3, Log of Boring B3, page 1 of 1

GEO\_NO\_WELL PROJ.GPJ 10/01/03







SAMPLE SYMBOLS	
 ... SAMPLING UNSUCCESSFUL	 ... STANDARD PENETRATION TEST
 ... DISTURBED OR BAG SAMPLE	 ... DRIVE SAMPLES (UNDISTURBED)
 ... CHUNK SAMPLE	 ... WATER TABLE OR SEEPAGE

NOTE: THE LOG OF SUBSURFACE CONDITIONS SHOWN HEREON APPLIES ONLY AT THE SPECIFIC BORING OR TRENCH LOCATION AND AT THE DATE INDICATED. IT IS NOT WARRANTED TO BE REPRESENTATIVE OF SUBSURFACE CONDITIONS AT OTHER LOCATIONS AND TIMES. ALL BLOW COUNTS HAVE BEEN CONVERTED TO EQUIVALENT STANDARD PENETRATION TEST (SPT) BLOW COUNTS

DEPTH IN FEET	SAMPLE NO.	LITHOLOGY	GROUNDWATER	SOIL CLASS (USCS)	BORING B4			PENETRATION RESISTANCE (BLOWS/FT.)	DRY DENSITY (P.C.F.)	MOISTURE CONTENT (%)
					ELEV. (MSL.)	DATE COMPLETED	EQUIPMENT			
					ELEV. (MSL.)	NA	DATE COMPLETED	9/10/03		
					EQUIPMENT	CME 75				
MATERIAL DESCRIPTION										
0					ALLUVIUM Soft, damp, very dark grayish brown (2.5Y 3/2), Silty CLAY - EI = 127 (high) - becomes stiff  - becomes very stiff, moist					
2	B4-2.5 B4-3			CH				16	99.9	21.7
4					Very stiff, moist, light yellowish brown (2.5Y 6/3), Sandy lean CLAY					
6	B4-5.5 B4-6			CL				25	96.4	17.8
8					Stiff, very moist, olive gray (5Y 4/2), Sandy CLAY, with some thin interbedded lean clay seams					
10	B4-10			CL				9		
12					Medium dense, very moist to wet, Sandy CLAY, trace plant remains					
14										
16	B4-15.5 B4-16			CL				17	99.0	27.6
BORING TERMINATED AT 16.5 FEET										

Figure B4, Log of Boring B4, page 1 of 1

GEO\_NO\_WELL PROJ GFI 100103







SAMPLE SYMBOLS					
	... SAMPLING UNSUCCESSFUL		... STANDARD PENETRATION TEST		... DRIVE SAMPLE (UNDISTURBED)
	... DISTURBED OR BAG SAMPLE		... CHUNK SAMPLE		... WATER TABLE OR SEEPAGE

NOTE: THE LOG OF SUBSURFACE CONDITIONS SHOWN HEREON APPLIES ONLY AT THE SPECIFIC BORING OR TRENCH LOCATION AND AT THE DATE INDICATED. IT IS NOT WARRANTED TO BE REPRESENTATIVE OF SUBSURFACE CONDITIONS AT OTHER LOCATIONS AND TIMES. ALL BLOW COUNTS HAVE BEEN CONVERTED TO EQUIVALENT STANDARD PENETRATION TEST (SPT) BLOW COUNTS

DEPTH IN FEET	SAMPLE NO.	LITHOLOGY	GROUNDWATER	BORING B5			PENETRATION RESISTANCE (BLOWS/FT.)	DRY DENSITY (P.C.F.)	MOISTURE CONTENT (%)
				SOIL CLASS (USCS)	ELEV. (MSL.)	DATE COMPLETED			
					NA	9/10/03			
					EQUIPMENT CME 75				
MATERIAL DESCRIPTION									
0					ALLUVIUM Soft, moist, very dark grayish brown (2.5Y, 3/2), Silty CLAY, moderate plasticity - EI = 90 (high) - becomes very stiff				
2	B5-3			CH	TV > 1.0, pp > 4.5	18	110.2	12.7	
4					Very stiff, moist, light olive brown (2.5Y 5/3), Sandy lean CLAY/Clayey SAND				
6	B5-5.5 B5-6			CL/SC		24	107.8	19.3	
8					Stiff, very moist, olive gray (5Y 4/2), Sandy CLAY, with some thin interbedded lean clay seams				
10	B5-10			CL		9			
12					Stiff, moist, olive gray (5Y 4/2), Silty Sandy CLAY				
14					TV = 5.9, pp = 3.5 - very moist	15	93.7	29.2	
16	B5-15.5 B5-16			CL					
BORING TERMINATED AT 16.5 FEET									

Figure B5, Log of Boring B5, page 1 of 1

GEO\_NO\_WELL PROJ.GPJ 10/01/03

SAMPLE SYMBOLS			
	... SAMPLING UNSUCCESSFUL		... STANDARD PENETRATION TEST
	... DISTURBED OR BAG SAMPLE		... CHUNK SAMPLE
			... DRIVE SAMPLE (UNDISTURBED)
			... WATER TABLE OR SEEPAGE

NOTE: THE LOG OF SUBSURFACE CONDITIONS SHOWN HEREON APPLIES ONLY AT THE SPECIFIC BORING OR TRENCH LOCATION AND AT THE DATE INDICATED. IT IS NOT WARRANTED TO BE REPRESENTATIVE OF SUBSURFACE CONDITIONS AT OTHER LOCATIONS AND TIMES. ALL BLOW COUNTS HAVE BEEN CONVERTED TO EQUIVALENT STANDARD PENETRATION TEST (SPT) BLOW COUNTS

DEPTH IN FEET	SAMPLE NO.	LITHOLOGY	GROUNDWATER	SOIL CLASS (USCS)	BORING B6		PENETRATION RESISTANCE (BLOWS/FT.)	DRY DENSITY (P.C.F.)	MOISTURE CONTENT (%)
					ELEV. (MSL.)	DATE COMPLETED			
					ELEV. (MSL.)	NA			
					EQUIPMENT	CME 75			
					MATERIAL DESCRIPTION				
0				CL	ALLUVIUM Firm, damp, light brownish gray (2.5Y 6/2), Silty CLAY - becomes stiff				
2				CL/SC	- $E_l = 88$ (high) Very stiff, moist, light olive brown (2.5Y 5/6), Sandy lean CLAY/Clayey SAND				
4	B6-3						21	112.6	15.2
6	B6-5			CH	Stiff, moist, light olive brown (2.5Y 5/6), Sandy CLAY, moderate to high plasticity				
8							8		
10									
10	B6-10.5 B6-11			SC	Loose, wet, light olive brown (2.5Y 5/6), Clayey SAND				
12							8		
14	B6-13.5			CL	Medium stiff, moist, olive gray (5Y 4/2), Silty CLAY, with trace plant fragments				
					BORING TERMINATED AT 15 FEET				

Figure B6, Log of Boring B6, page 1 of 1

GEO\_NO\_WELL PROJ.GPJ 10/01/03

SAMPLE SYMBOLS					
	... SAMPLING UNSUCCESSFUL		... STANDARD PENETRATION TEST		... DRIVE SAMPLE (UNDISTURBED)
	... DISTURBED OR BAG SAMPLE		... CHUNK SAMPLE		... WATER TABLE OR SEEPAGE

NOTE: THE LOG OF SUBSURFACE CONDITIONS SHOWN HEREON APPLIES ONLY AT THE SPECIFIC BORING OR TRENCH LOCATION AND AT THE DATE INDICATED. IT IS NOT WARRANTED TO BE REPRESENTATIVE OF SUBSURFACE CONDITIONS AT OTHER LOCATIONS AND TIMES. ALL BLOW COUNTS HAVE BEEN CONVERTED TO EQUIVALENT STANDARD PENETRATION TEST (SPT) BLOW COUNTS

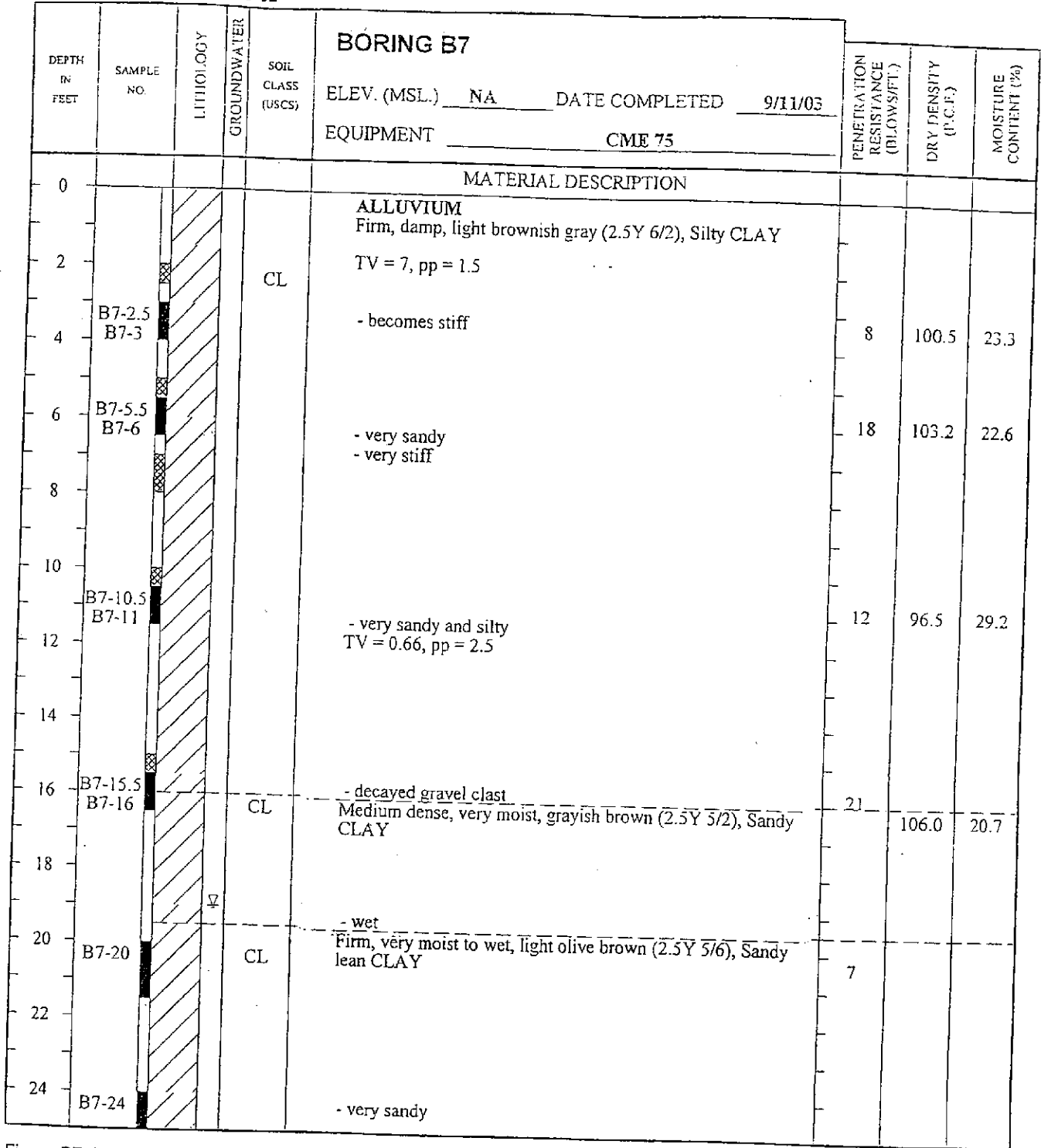

Figure B7, Log of Boring B7, page 1 of 3

GEO\_NO\_WELL PROJ.GPJ 10/01/03

SAMPLE SYMBOLS					
	... SAMPLING UNSUCCESSFUL		... STANDARD PENETRATION TEST		... DRIVE SAMPLE (UNDISTURBED)
	... DISTURBED OR BAG SAMPLE		... CHUNK SAMPLE		... WATER TABLE OR SEEPAGE

NOTE: THE LOG OF SUBSURFACE CONDITIONS SHOWN HEREON APPLIES ONLY AT THE SPECIFIC BORING OR TRENCH LOCATION AND AT THE DATE INDICATED. IT IS NOT WARRANTED TO BE REPRESENTATIVE OF SUBSURFACE CONDITIONS AT OTHER LOCATIONS AND TIMES. ALL BLOW COUNTS HAVE BEEN CONVERTED TO EQUIVALENT STANDARD PENETRATION TEST (SPT) BLOW COUNTS



DEPTH IN FEET	SAMPLE NO.	LITHOLOGY	GROUNDWATER	SOIL CLASS (USCS)	BORING B7		PENETRATION RESISTANCE (BLOWS/FT.)	DRY DENSITY (P.C.F.)	MOISTURE CONTENT (%)
					ELEV. (MSL.)	DATE COMPLETED			
					NA	9/11/03			
					EQUIPMENT CME 75				
MATERIAL DESCRIPTION									
26	B7-25.5 B7-26			CL	- becomes stiff TV = 0.75, pp = 1.7		9		
28					- sand content decreases				
30	B7-30.5 B7-31				- stiff TV = 0.56, pp = 2.2		13		
32									
34									
36	B7-36				TV = 0.55, pp = 1.2		13		
38									
40					TV = 0.9, pp = 1.7				
42	B7-41						13	69.0	54.6
44									
46	B7-46				- becomes very stiff TV = 0.57, pp = 2.5		23	96.7	27.4
48									

Figure B8, Log of Boring B7, page 2 of 3

GEO\_NO\_WELL PROJ.GPJ 10/01/03

SAMPLE SYMBOLS					
<input type="checkbox"/>	... SAMPLING UNSUCCESSFUL	<input type="checkbox"/>	... STANDARD PENETRATION TEST	<input type="checkbox"/>	... DRIVE SAMPLE (UNDISTURBED)
<input checked="" type="checkbox"/>	... DISTURBED OR BAG SAMPLE	<input checked="" type="checkbox"/>	... CHUNK SAMPLE	<input checked="" type="checkbox"/>	... WATER TABLE OR SEEPAGE

NOTE: THE LOG OF SUBSURFACE CONDITIONS SHOWN HEREON APPLIES ONLY AT THE SPECIFIC BORING OR TRENCH LOCATION AND AT THE DATE INDICATED. IT IS NOT WARRANTED TO BE REPRESENTATIVE OF SUBSURFACE CONDITIONS AT OTHER LOCATIONS AND TIMES. ALL BLOW COUNTS HAVE BEEN CONVERTED TO EQUIVALENT STANDARD PENETRATION TEST (SPT) BLOW COUNTS

PROJECT NO. S8689-06-02

DEPTH IN FEET	SAMPLE NO.	LITHOLOGY	GROUNDWATER	SOIL CLASS (USCS)	BORING B7		PENETRATION RESISTANCE (BLOWS/FT.)	DRY DENSITY (P.C.F.)	MOISTURE CONTENT (%)
					ELEV. (MSL.)	DATE COMPLETED			
					NA	9/11/03			
					EQUIPMENT CME 75				
50	B7-51			CL	MATERIAL DESCRIPTION - hard, calcareous TV = 0.5, pp = 4.0				
					BORING TERMINATED AT 51.5 FEET		28	105.3	22.9

Figure B9, Log of Boring B7, page 3 of 3

GEO\_NO\_WELL PROJ.GPJ 10/01/03

SAMPLE SYMBOLS		
<input type="checkbox"/>	... SAMPLING UNSUCCESSFUL	<input type="checkbox"/>
<input checked="" type="checkbox"/>	... DISTURBED OR BAG SAMPLE	<input type="checkbox"/>
<input type="checkbox"/>	... STANDARD PENETRATION TEST	<input checked="" type="checkbox"/>
<input type="checkbox"/>	... CHUNK SAMPLE	<input type="checkbox"/>
<input type="checkbox"/>	... WATER TABLE OR SEEPAGE	

NOTE: THE LOG OF SUBSURFACE CONDITIONS SHOWN HEREON APPLIES ONLY AT THE SPECIFIC BORING OR TRENCH LOCATION AND AT THE DATE INDICATED. IT IS NOT WARRANTED TO BE REPRESENTATIVE OF SUBSURFACE CONDITIONS AT OTHER LOCATIONS AND TIMES. ALL BLOW COUNTS HAVE BEEN CONVERTED TO EQUIVALENT STANDARD PENETRATION TEST (SPT) BLOW COUNTS

DEPTH IN FEET	SAMPLE NO.	LITHOLOGY	GROUNDWATER	SOIL CLASS (USCS)	BORING B8		PENETRATION RESISTANCE (BLOWS/FT.)	DRY DENSITY (P.C.F.)	MOISTURE CONTENT (%)
					ELEV. (MSL.)	DATE COMPLETED			
					ELEV. (MSL.)	NA	DATE COMPLETED	8/9/03	
					EQUIPMENT	CME 75			
MATERIAL DESCRIPTION									
0					ALLUVIUM				
2	NO REC			CH	Stiff, dry, dark gray (2.5Y N4/), Silty CLAY, 2" wide expansion cracks on surface		19		
4	B8-4				- becomes moist				
6	B8-5.5 B8-6			SC/CL	Medium dense, damp, light brownish gray (2.5Y 6/2), Clayey SAND/Sandy CLAY		20	110.3	19.6
8									
10	B8-10			SC	Loose, wet, dark gray (2.5Y N4/), Clayey SAND		6		
12									
14	B8-14			CL	Stiff, moist, dark gray (2.5Y N4/), Sandy CLAY, low to moderate plasticity				
BORING TERMINATED AT 15 FEET									

Figure B10, Log of Boring B8, page 1 of 1

GEO\_NO\_WELL PROJ.GPJ 10/01/03











SAMPLE SYMBOLS					
<input type="checkbox"/>	... SAMPLING UNSUCCESSFUL	<input type="checkbox"/>	... STANDARD PENETRATION TEST	<input checked="" type="checkbox"/>	... DRIVE SAMPLE (UNDISTURBED)
<input checked="" type="checkbox"/>	... DISTURBED OR BAG SAMPLE	<input checked="" type="checkbox"/>	... CHUNK SAMPLE	<input type="checkbox"/>	... WATER TABLE OR SEEPAGE

NOTE: THE LOG OF SUBSURFACE CONDITIONS SHOWN HEREON APPLIES ONLY AT THE SPECIFIC BORING OR TRENCH LOCATION AND AT THE DATE INDICATED. IT IS NOT WARRANTED TO BE REPRESENTATIVE OF SUBSURFACE CONDITIONS AT OTHER LOCATIONS AND TIMES. ALL BLOW COUNTS HAVE BEEN CONVERTED TO EQUIVALENT STANDARD PENETRATION TEST (SPT) BLOW COUNTS

DEPTH IN FEET	SAMPLE NO.	LITHOLOGY	GROUNDWATER	BORING B9		PENETRATION RESISTANCE (BLOW/FT.)	DRY DENSITY (P.C.F.)	MOISTURE CONTENT (%)
				ELEV. (MSL.)	DATE COMPLETED			
					NA	9/11/03		
					EQUIPMENT	CME 75		
MATERIAL DESCRIPTION								
0					ALLUVIUM			
2	B9-1			CH	Stiff, dry, dark gray (2.5Y N/4), Silty CLAY			
4	B9-3			CL/SC	- EI = 139 (very high) Stiff, damp, light brownish gray (2.5Y 6/2), Sandy CLAY/Clayey SAND	9	99.4	24.7
6	B9-5.5 B9-6				- very moist	13	106.9	22.0
8	B9-7			CL	Stiff, very moist, dark gray (2.5Y N/4), Sandy CLAY			
10								
12	B9-10.5 B9-11					12	87.0	27.6
14								
16	B9-15			SC	Loose, wet, dark gray (2.5Y N/4), Clayey SAND	9		
BORING TERMINATED AT 16.5 FEET								

Figure B11, Log of Boring B9, page 1 of 1

GEO\_NO\_WELL PROJ.GPJ 10/01/03

SAMPLE SYMBOLS		
	... SAMPLING UNSUCCESSFUL	
	... DISTURBED OR BAG SAMPLE	
	... STANDARD PENETRATION TEST	
	... DRIVE SAMPLE (UNDISTURBED)	
	... CHUNK SAMPLE	
	... WATER TABLE OR SEEPAGE	

NOTE: THE LOG OF SUBSURFACE CONDITIONS SHOWN HEREON APPLIES ONLY AT THE SPECIFIC BORING OR TRENCH LOCATION AND AT THE DATE INDICATED. IT IS NOT WARRANTED TO BE REPRESENTATIVE OF SUBSURFACE CONDITIONS AT OTHER LOCATIONS AND TIMES. ALL BLOW COUNTS HAVE BEEN CONVERTED TO EQUIVALENT STANDARD PENETRATION TEST (SPT) BLOW COUNTS

DEPTH IN FEET	SAMPLE NO.	LITHOLOGY	GROUNDWATER	SOIL CLASS (USCS)	BORING B10		PENETRATION RESISTANCE (BLOWS/FT.)	DRY DENSITY (P.C.F.)	MOISTURE CONTENT (%)
					ELEV. (MSL.)	DATE COMPLETED			
						NA	9/11/03		
						EQUIPMENT	CME 75		
MATERIAL DESCRIPTION									
0	B10-0.5			CH	ALLUVIUM Stiff, damp, dark gray (2.5Y N/4), Silty CLAY - EI = 91 (high)				
2	B10-2.5 B10-3			CL/SC	Very stiff, damp, light brownish gray (2.5Y 6/2), Sandy CLAY/Clayey SAND	30	105.4	22.0	
4									
6	B10-5.5 B10-6 B10-6.5				- becomes stiff	15	104.1	23.1	
8									
10	B10-10			SC	Medium dense, very moist, dark gray (2.5Y N/4), Clayey SAND	13			
12					- wet				
14	B10-14 B10-14.5			CL	Very stiff, moist, grayish brown, Sandy CLAY	23	113.1	19.4	
BORING TERMINATED AT 15 FEET									

Figure B12, Log of Boring B10, page 1 of 1

GEO\_NO\_WELL PROJ.GPJ 10/01/03

SAMPLE SYMBOLS		
	... SAMPLING UNSUCCESSFUL	
	... DISTURBED OR BAG SAMPLE	
	... STANDARD PENETRATION TEST	
	... CHUNK SAMPLE	
		... DRIVE SAMPLE (UNDISTURBED)
		... WATER TABLE OR SEEPAGE

NOTE: THE LOG OF SUBSURFACE CONDITIONS SHOWN HEREON APPLIES ONLY AT THE SPECIFIC BORING OR TRENCH LOCATION AND AT THE DATE INDICATED. IT IS NOT WARRANTED TO BE REPRESENTATIVE OF SUBSURFACE CONDITIONS AT OTHER LOCATIONS AND TIMES. ALL BLOW COUNTS HAVE BEEN CONVERTED TO EQUIVALENT STANDARD PENETRATION TEST (SPT) BLOW COUNTS

DEPTH IN FEET	SAMPLE NO.	LITHOLOGY	GROUNDWATER	SOIL CLASS (USCS)	BORING B11		PENETRATION RESISTANCE (BLOWS/FT.)	DRY DENSITY (P.C.F.)	MOISTURE CONTENT (%)
					ELEV. (MSL.)	DATE COMPLETED			
					ELEV. (MSL.)	NA			
					EQUIPMENT	CME 75			
MATERIAL DESCRIPTION									
0	B11-0.5	[Hatched pattern]		CH	ALLUVIUM Stiff, damp, dark gray (2.5Y N/4), Silty CLAY				
2				CL	Stiff, damp, light brownish gray (2.5Y 6/2), Sandy Silty CLAY				
4	B11-3					11	91.9	28.1	
6	B11-5.5 B11-6				TV = 5.0, pp = 3.1	11	97.9	27.8	
8	B11-7								
10			▽	SC	Medium dense, very moist, dark gray (2.5Y N/4), Clayey SAND				
10.5	B11-10.5			CL	Stiff, very moist, dark gray (2.5Y N/4), Sandy Silty CLAY	14			
12									
14	B11-14 B11-14.5				- becomes very stiff TV = 0.68, pp = 2.5	18	87.7	13.5	
BORING TERMINATED AT 15 FEET									

Figure B13, Log of Boring B11, page 1 of 1

GEO\_NO\_WELL PROJ.GPJ 1001/03

SAMPLE SYMBOLS					
<input type="checkbox"/>	... SAMPLING UNSUCCESSFUL	<input type="checkbox"/>	... STANDARD PENETRATION TEST	<input type="checkbox"/>	... DRIVE SAMPLE (UNDISTURBED)
<input type="checkbox"/>	... DISTURBED OR BAG SAMPLE	<input type="checkbox"/>	... CHUNK SAMPLE	<input type="checkbox"/>	... WATER TABLE OR SEEPAGE

NOTE: THE LOG OF SUBSURFACE CONDITIONS SHOWN HEREON APPLIES ONLY AT THE SPECIFIC BORING OR TRENCH LOCATION AND AT THE DATE INDICATED. IT IS NOT WARRANTED TO BE REPRESENTATIVE OF SUBSURFACE CONDITIONS AT OTHER LOCATIONS AND TIMES. ALL BLOW COUNTS HAVE BEEN CONVERTED TO EQUIVALENT STANDARD PENETRATION TEST (SPT) BLOW COUNTS



GEOCON

Site : PROJECT G  
Location : CPT-01

Engineer : J. ZORNE  
Date : 09:19:03 09:12

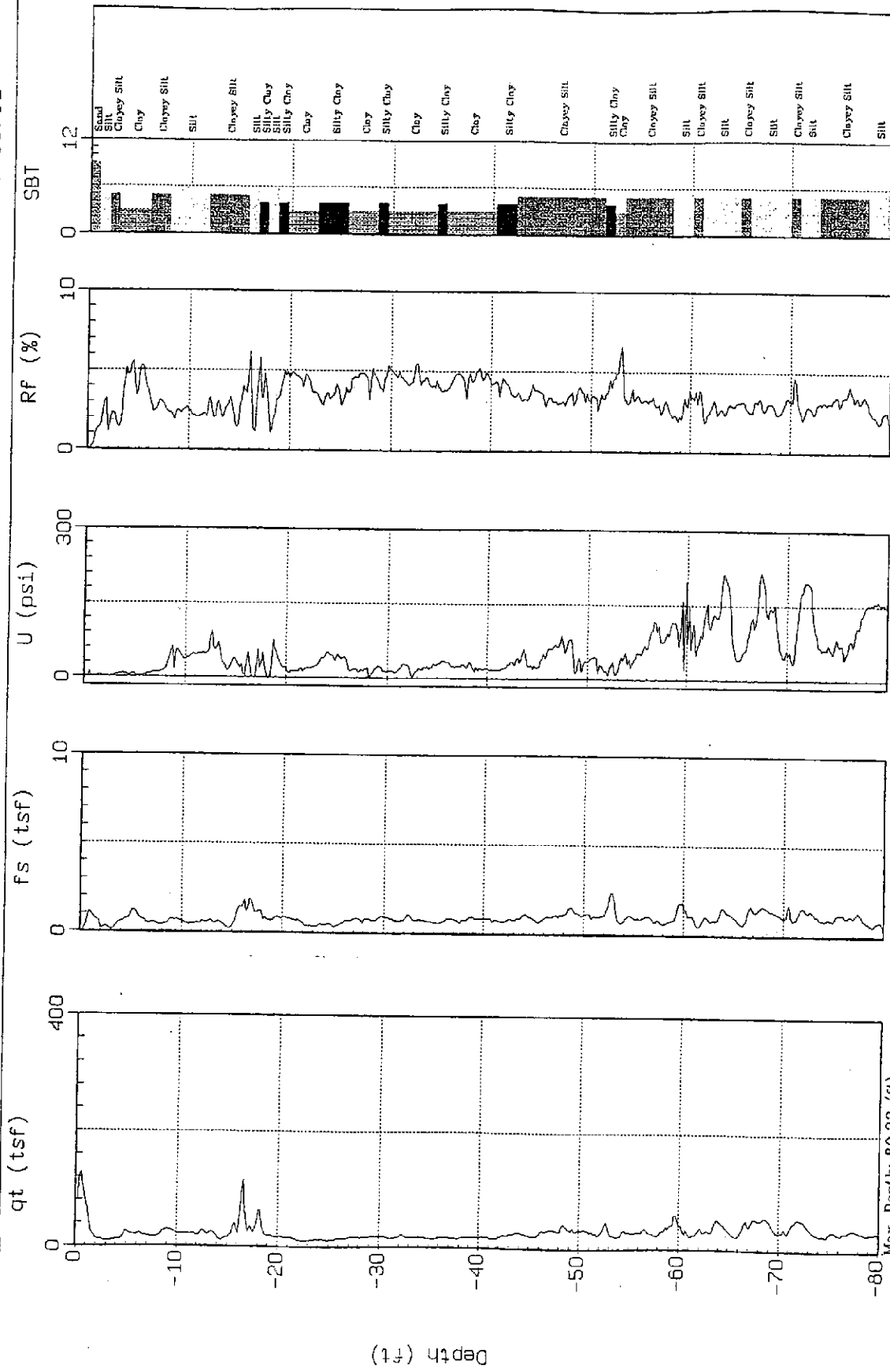

SBT: Soil Behavior Type (Robertson 1990)

Max Depth: 60.22 (ft)  
Depth Inc.: 0.164 (ft)



GEOCON

Site : PROJECT G  
Location : CPT-02

Engineer : J. ZORNE  
Date : 09:19:03 10:17

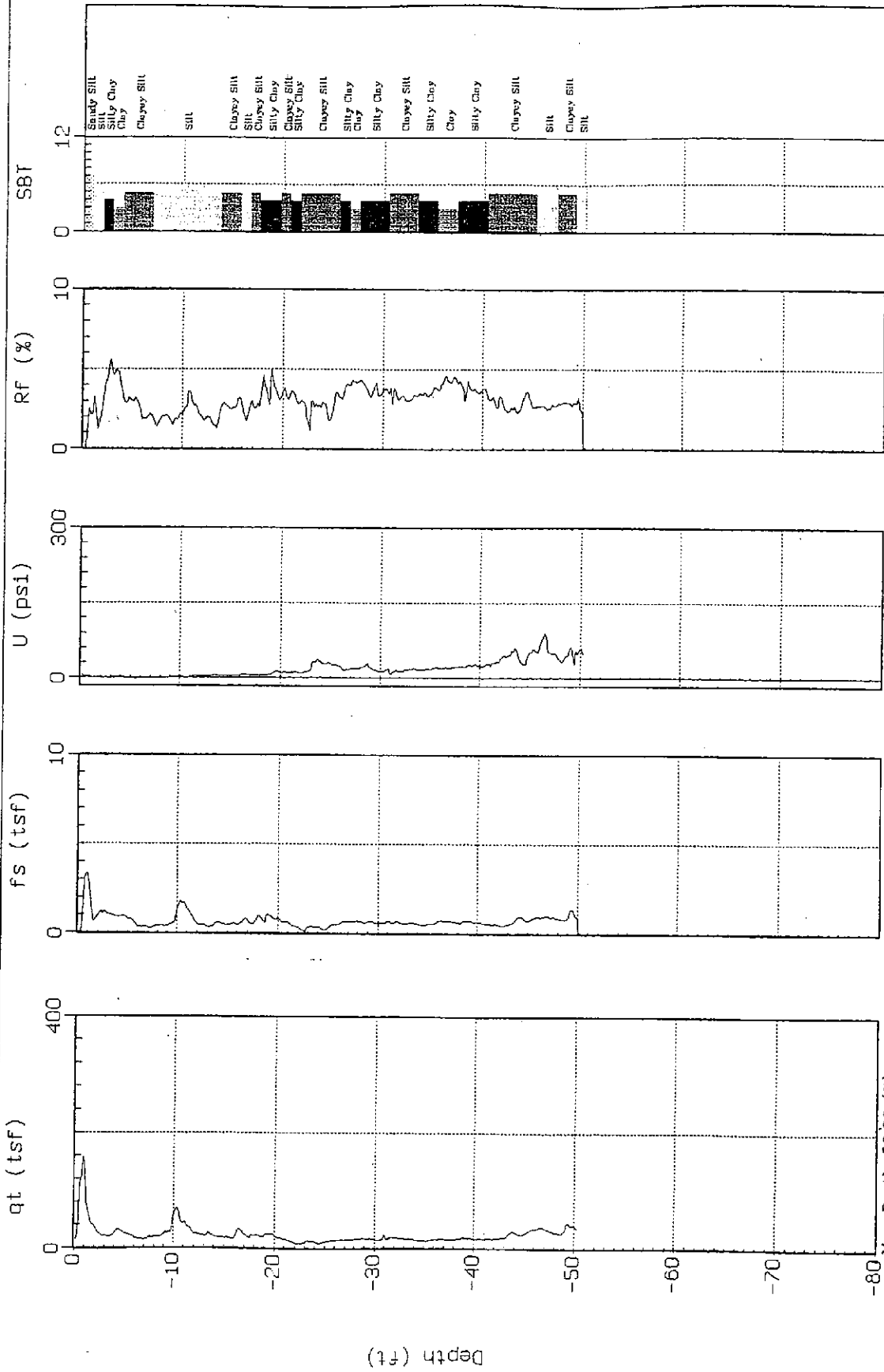

SBT: Soil Behavior Type (Robertson 1990)

Max. Depth: 50.20 (ft)  
Depth Inc.: 0.164 (ft)





GEOCON

Site : PROJECT 6  
Location : CPT-03

Engineer : J. ZORNE  
Date : 09:19:03 11:46

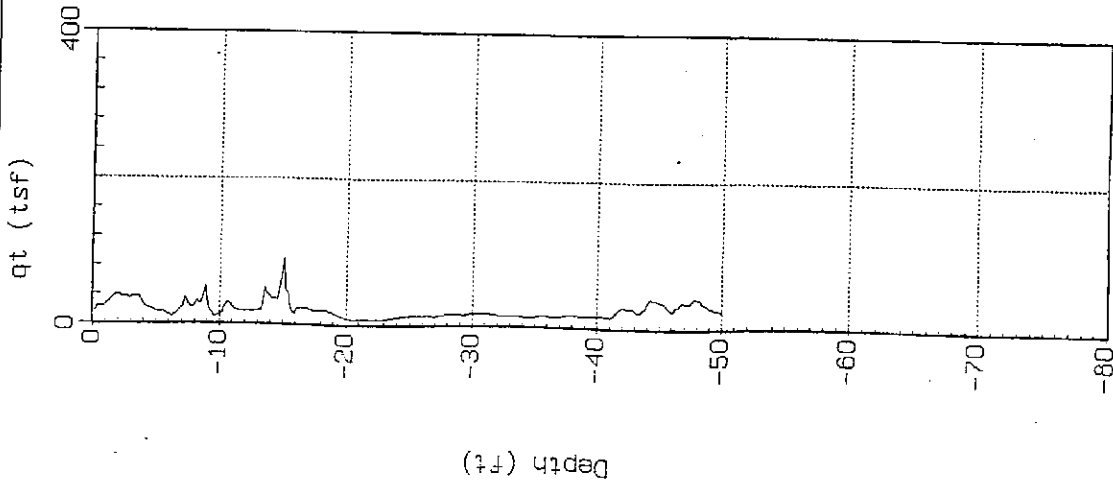

Max. Depth: 50.03 (ft)  
Depth Inc.: 0.164 (ft)

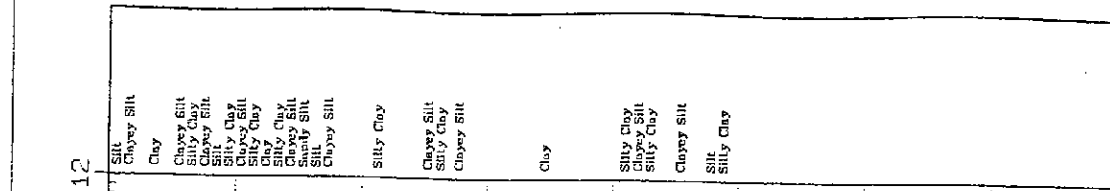
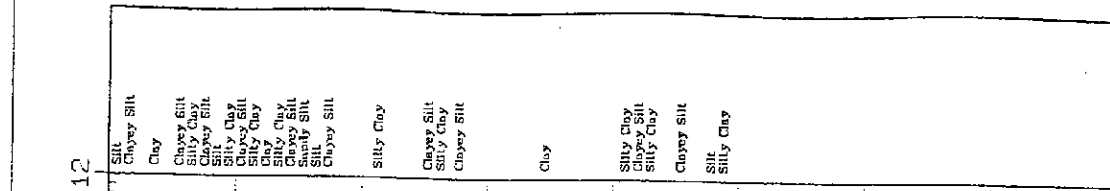
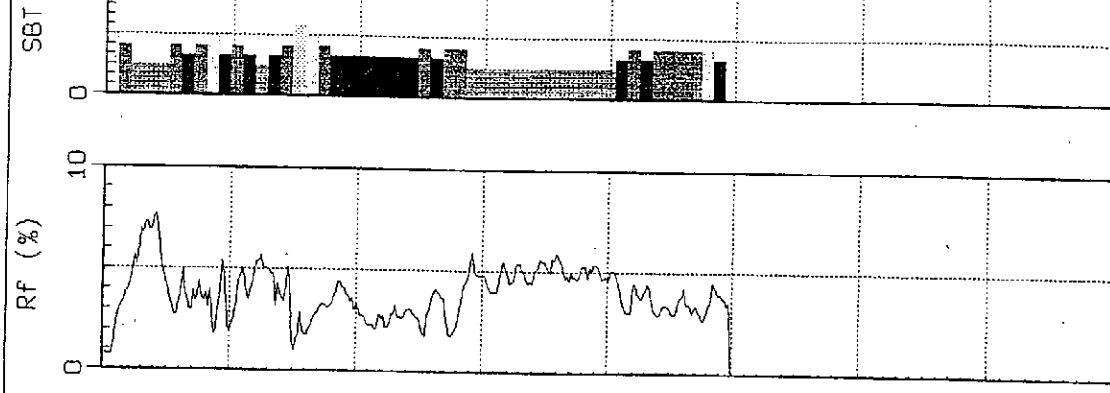
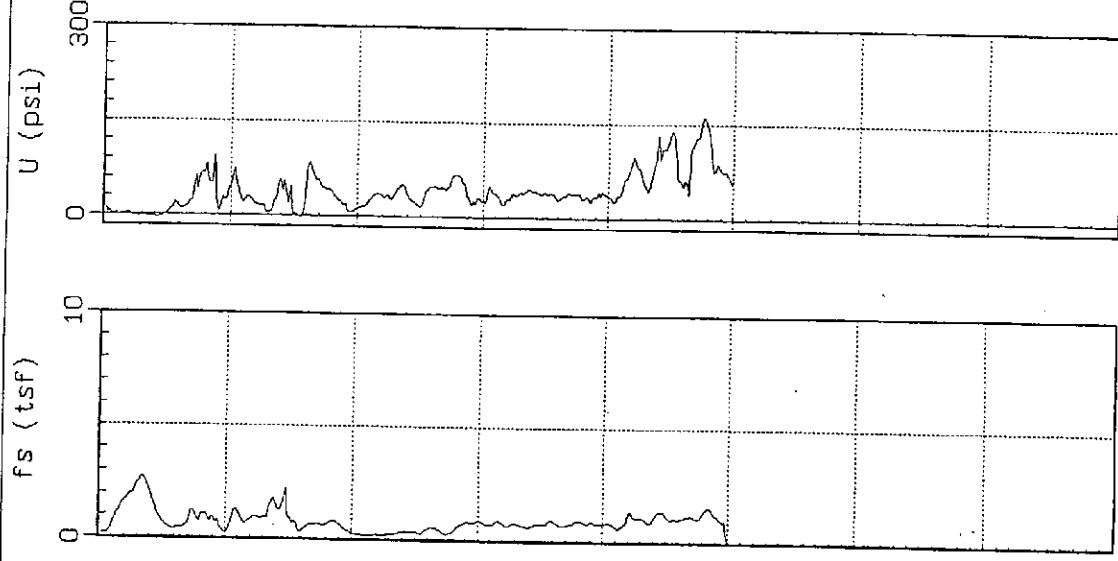

SBT: Soil Behavior Type (Robertson 1990)

Soil Behavior Type (Robertson 1990) legend:

- Silt
- Clayey Silt
- Clay
- Clayey Silt
- Silty Clay
- Clayey Silt
- Silt
- Silty Clay
- Clay
- Silty Clay
- Clay
- Silty Clay
- Clayey Silt
- Silt
- Clayey Silt
- Silty Clay
- Silty Clay
- Clayey Silt
- Silt
- Silty Clay



GEOCON

Site : PROJECT G  
Location : CPT-04

Engineer : J. ZORNE  
Date : 09:19:03 12:26

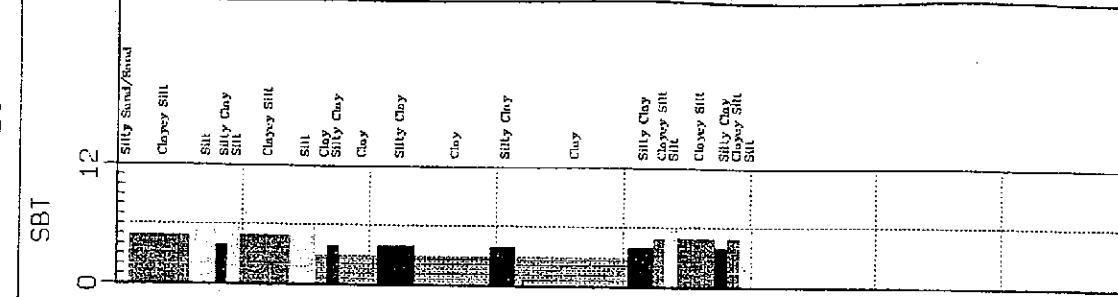
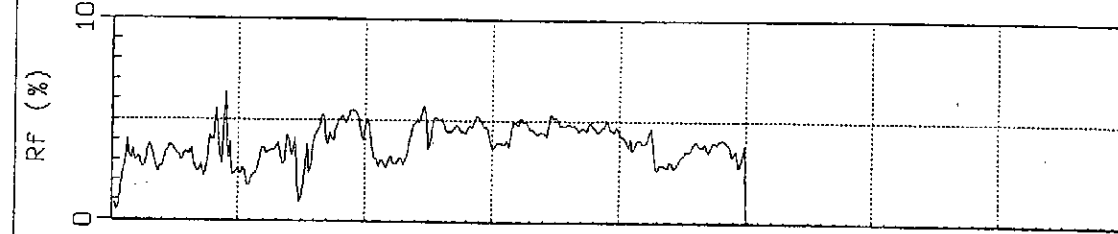
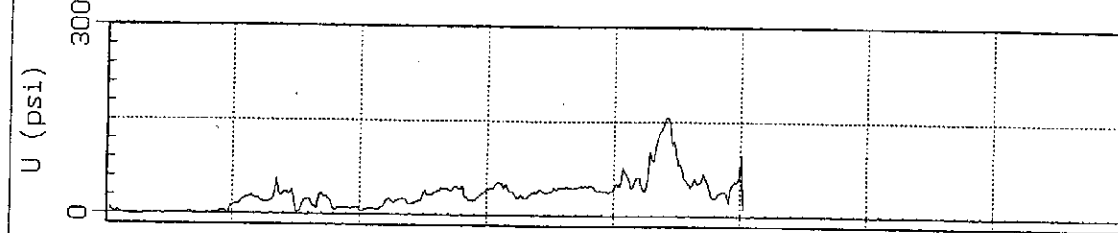
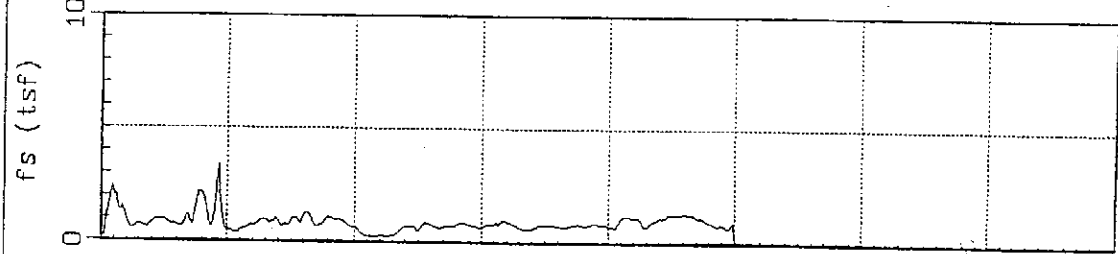
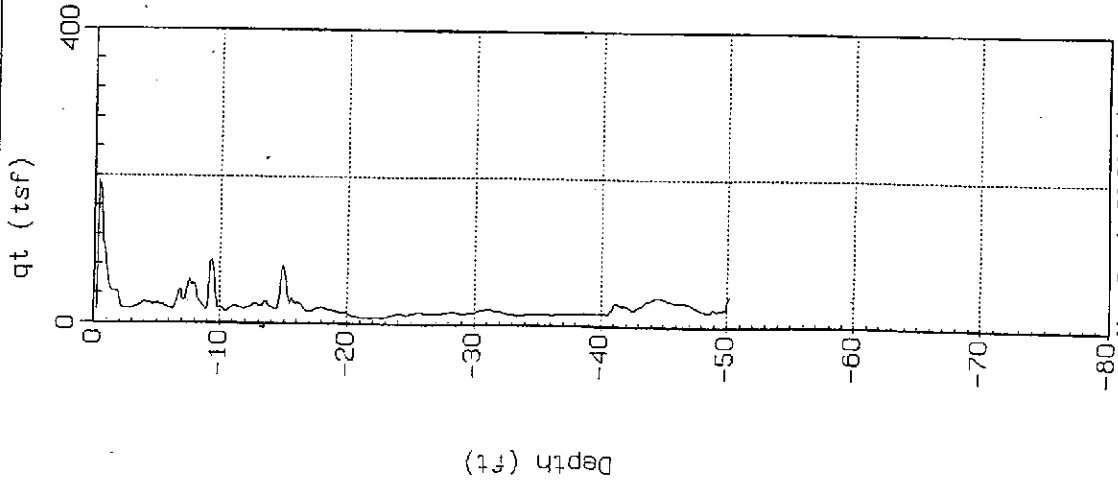

Max. Depth: 50.20 (ft)  
Depth Inc.: 0.164 (ft)

SBT: Soil Behavior Type (Robertson 1990)



GEOCON

Site : PROJECT G  
Location : CPT-05

Engineer : J. ZORNE  
Date : 09:19:03 13:14

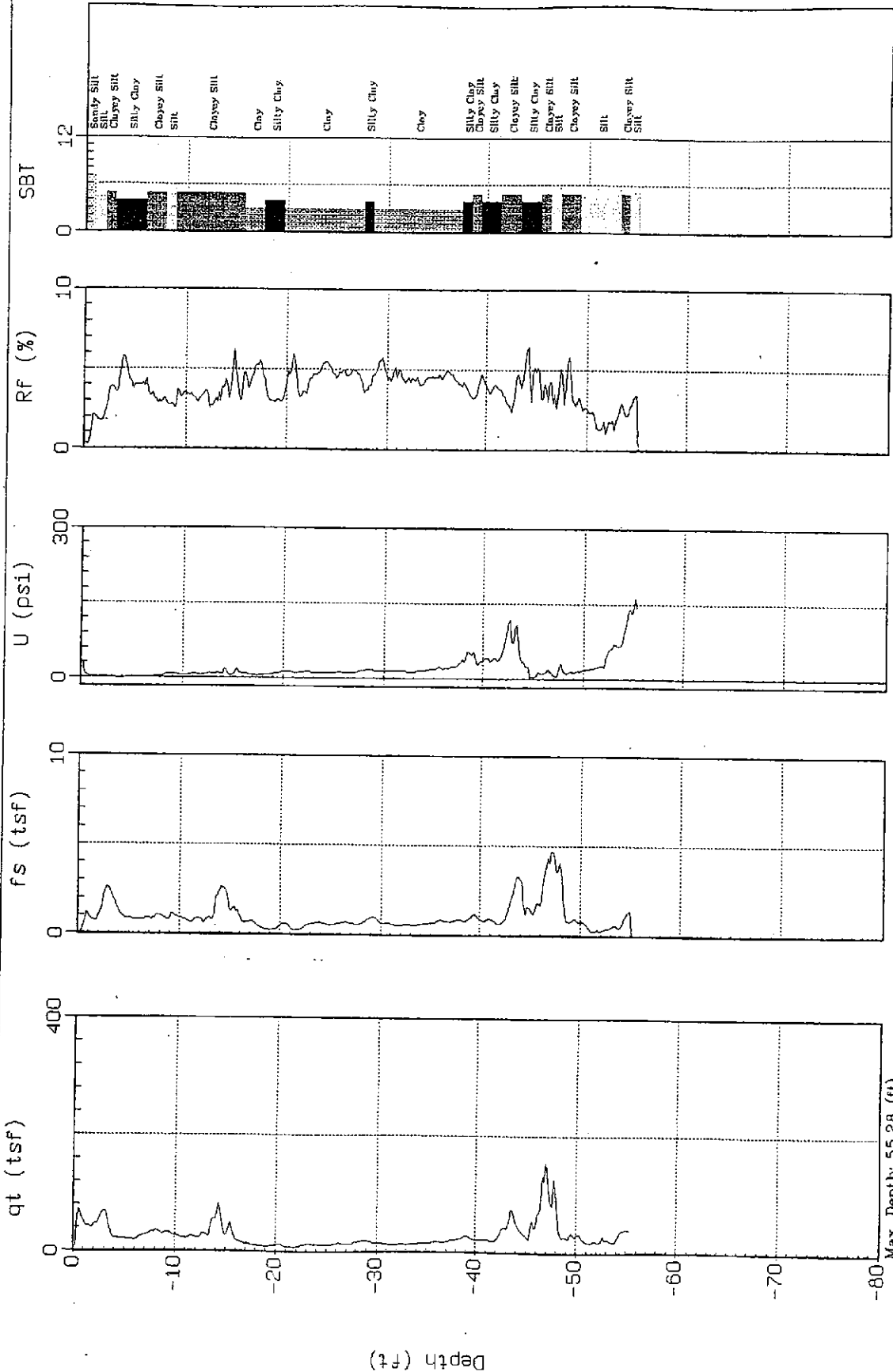

SBT: Soil Behavior Type (Robertson 1990)

Max. Depth: 55.28 (ft)  
Depth Inc.: 0.164 (ft)



GEOCON

Site : PROJECT G  
 Location : CPT-06

Engineer : J. ZORNE  
 Date : 09:19:03 14:02

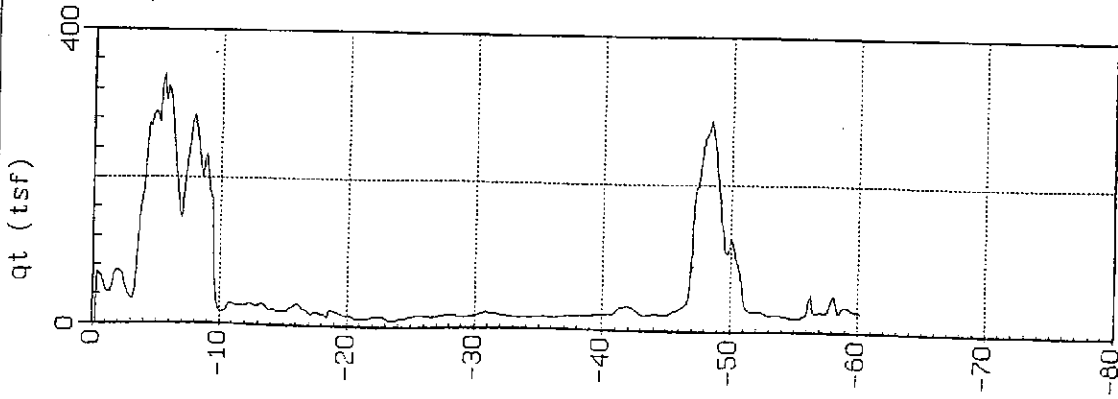

Max Depth: 60.20 (ft)  
 Depth. Inc.: 0.164 (ft)

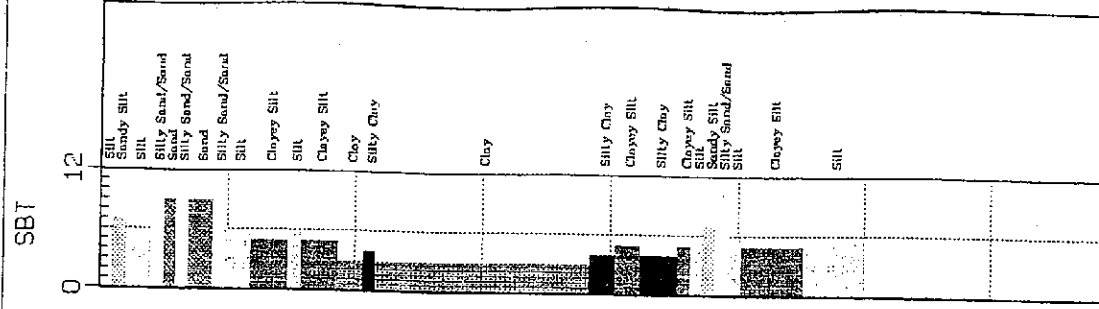
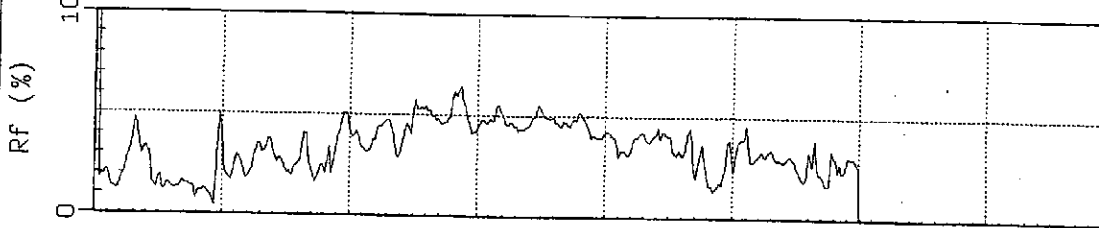
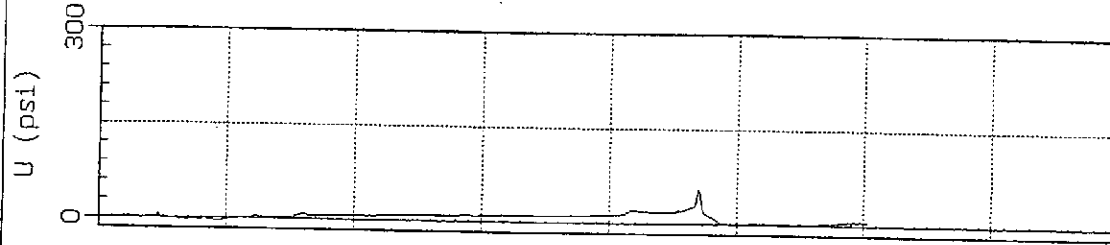
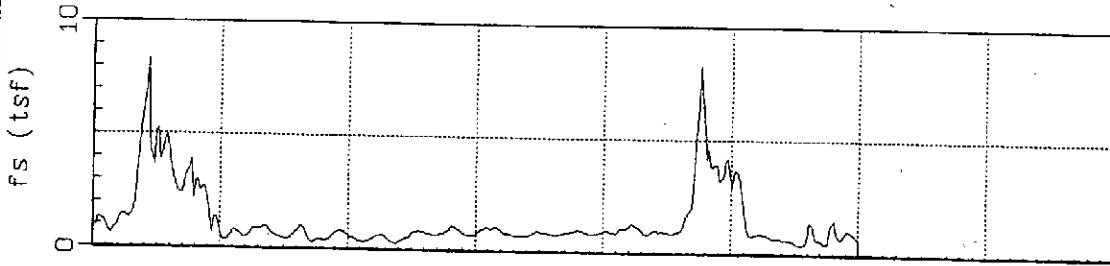

SBT: Soil Behavior Type (Robertson 1990)

Depth (ft)

APPENDIX



C

## APPENDIX C

### LABORATORY TESTING

Laboratory tests were performed in accordance with generally accepted test methods of the American Society for Testing and Materials (ASTM) procedures. Selected samples were tested for their in-place dry density, moisture content, plasticity index, expansion potential, shear strength parameters, consolidation characteristics, and corrosion potential. The test results and worksheets are included herein.

DRAFT

## WATER CONTENT/DRY DENSITY

ASTM C566/D2216/D2937 or AASHTO T255/T265

Project: Project G	Proj #: S8689-06-02
Date Tested: 9-22-03	Lab #: CV569
Tested By: R. Buto and F. Thomsen	Checked By: GL

Sample #	B1-3	Sample #	B1-6	Sample #	B1-11	Sample #	B1-16
Tare #		Tare #		Tare #		Tare #	
Tare wt	193.2	Tare wt	197.3	Tare wt	194.9	Tare wt	190.9
Wet wt+tare	888.9	Wet wt+tare	1075.8	Wet wt+tare	1102.5	Wet wt+tare	995.3
Dry wt + tare	829.7	Dry wt + tare	980.3	Dry wt + tare	925.8	Dry wt + tare	828.5
Wt of water	59.2	Wt of water	95.5	Wt of water	176.7	Wt of water	166.8
Dry wt.	636.5	Dry wt.	783	Dry wt.	730.9	Dry wt.	637.6
Height	4.87	Height	5.31	Height	6	Height	5.45
Diameter	2.4	Diameter	2.4	Diameter	2.4	Diameter	2.4
Wet Density	120.3	Wet Density	139.3	Wet Density	127.4	Wet Density	124.3
Dry Density	110.1	Dry Density	124.2	Dry Density	102.6	Dry Density	98.5
% Moisture	9.3%	% Moisture	12.2%	% Moisture	24.2%	% Moisture	26.2%

Sample #	B2-6	Sample #	B2-11	Sample #	B2-21	Sample #	B3-6
Tare #		Tare #		Tare #		Tare #	
Tare wt	192.1	Tare wt	191.2	Tare wt	197.2	Tare wt	193.3
Wet wt+tare	1019.4	Wet wt+tare	1018.3	Wet wt+tare	882.7	Wet wt+tare	1028.8
Dry wt + tare	849.9	Dry wt + tare	844.7	Dry wt + tare	630.9	Dry wt + tare	850.6
Wt of water	169.5	Wt of water	173.6	Wt of water	251.8	Wt of water	178.2
Dry wt.	657.8	Dry wt.	653.5	Dry wt.	433.7	Dry wt.	657.3
Height	5.62	Height	5.52	Height	5.57	Height	5.97
Diameter	2.4	Diameter	2.4	Diameter	2.4	Diameter	2.4
Wet Density	124.0	Wet Density	126.2	Wet Density	103.6	Wet Density	117.9
Dry Density	98.6	Dry Density	99.7	Dry Density	65.6	Dry Density	92.7
% Moisture	25.8%	% Moisture	26.6%	% Moisture	58.1%	% Moisture	27.1%

**Material Descriptions:** (Depth, Location, Source, Classification, etc.)

Sample # B1-3	Clayey Sand with Gravel - Brown 4/3 7.5yr
Sample # B1-6	Well Graded Sand with Clay and Gravel - Greyish Brown 5/2 10yr
Sample # B1-11	Clay with Sand - Brown 4/3 10yr
Sample # B1-16	Clay - Dark Greenish Grey 4/1 gley 1
Sample # B2-6	Clay - Brown 4/2 7.5yr
Sample # B2-11	Clay with fine Sand - Dark Yellowish Brown 3/4 10yr
Sample # B2-21	Clay - Dark Greenish Grey 3/1 gley 1
Sample # B3-6	Clay with Sand - Dark Yellowish Brown 3/4 10yr

C566/T255 Nominal Max Size of Agg.		D2216 Min. Mass		T265 Max Part Size		Notes:
#4	500g	#10	20g	#40	10g	
3/8"	1500g	#4	100g	#4	100g	
1/2"	2000g	3/8"	500g	1/2"	300g	
3/4"	3000g	3/4"	2500g	1"	500g	
1"	4000g	1 1/2"	10kg	2"	1000g	
1 1/2"	6000g	3"	50kg			

**GEOCON Inc.**

## WATER CONTENT/DRY DENSITY

ASTM C566/D2216/D2937 or AASHTO T255/T265

Project: Project G	Proj #: S8689-06-02
Date Tested: 9-22-03	Lab#: CV569
Tested By: R. Buto and F. Thomsen	Checked By: GL

Sample #	B3-11	Sample #	B3-17	Sample #	B4-2.5	Sample #	B4-5.5
Tare #		Tare #		Tare #		Tare #	
Tare wt	197.7	Tare wt	107.2	Tare wt	299.8	Tare wt	296.8
Wet wt+tare	992.9	Wet wt+tare	906.2	Wet wt+tare	1066.1	Wet wt+tare	721.7
Dry wt + tare	821	Dry wt + tare	748.2	Dry wt + tare	929.6	Dry wt + tare	657.4
Wt of water	171.9	Wt of water	158	Wt of water	136.5	Wt of water	64.3
Dry wt	623.3	Dry wt	641	Dry wt	629.8	Dry wt	360.6
Height	5.39	Height	5.27	Height	5.31	Height	3.15
Diameter	2.4	Diameter	2.4	Diameter	2.4	Diameter	2.4
Wet Density	124.2	Wet Density	127.7	Wet Density	121.5	Wet Density	113.6
Dry Density	97.4	Dry Density	102.4	Dry Density	99.9	Dry Density	96.4
% Moisture	27.6%	% Moisture	24.6%	% Moisture	21.7%	% Moisture	17.8%

Sample #	B4-16	Sample #	B5-3	Sample #	B5-6	Sample #	B5-16
Tare #		Tare #		Tare #		Tare #	
Tare wt	296.8	Tare wt	298.8	Tare wt	32.4	Tare wt	32.2
Wet wt+tare	1084.5	Wet wt+tare	1069.9	Wet wt+tare	841.8	Wet wt+tare	844.7
Dry wt + tare	914.3	Dry wt + tare	983.1	Dry wt + tare	710.7	Dry wt + tare	661
Wt of water	170.2	Wt of water	86.8	Wt of water	131.1	Wt of water	183.7
Dry wt	617.5	Dry wt	684.3	Dry wt	678.3	Dry wt	628.8
Height	5.25	Height	5.23	Height	5.3	Height	5.65
Diameter	2.4	Diameter	2.4	Diameter	2.4	Diameter	2.4
Wet Density	126.3	Wet Density	124.2	Wet Density	128.6	Wet Density	121.1
Dry Density	99.0	Dry Density	110.2	Dry Density	107.8	Dry Density	93.7
% Moisture	27.6%	% Moisture	12.7%	% Moisture	19.3%	% Moisture	29.2%

Material Descriptions: (Depth, Location, Source, Classification, etc.)	
Sample # B3-11	Sandy Clay - Dark Greenish Grey 3/1 Gley 1
Sample # B3-17	Clay with Sand - Very Dark Grey 3/1 10yr
Sample # B4-2.5	Clay with Sand - Very Dark Grey 3/1 10yr
Sample # B4-5.5	Clayey Sand - Brown 5/4 7.5yr
Sample # B4-16	Clay with Sand - Dark Greenish Grey 3.1 Gley 2
Sample # B5-3	Clayey Sand - Dark Brown 3/2 7.5yr
Sample # B5-6	Clayey Sand - Dark Brown 4/2 7.5yr
Sample # B5-16	Clay with Sand - Greenish Grey 4/1 Gley 2

C566/T255 Nominal Max. Size of Agg.	D2216 Min. Mass	T265 Max Part Size	Notes:
#4 500g	#10 20g	#40 10g	Wet Density=Wet Wt/453.6/vol of tube Dry Density=Wet Density/1+ Moisture % Volume of tube= 3.14159(r <sub>2</sub> )h = inches. inches./1728 ft <sup>3</sup> = volume
3/8" 1500g	#4 100g	#4 100g	
1/2" 2000g	3/8" 500g	1/2" 300g	
3/4" 3000g	3/4" 2500g	1" 500g	
1" 4000g	1 1/2" 10kg	2" 1000g	
1 1/2" 6000g	3" 50kg		

**GEOCON Inc.**



**WATER CONTENT / DRY DENSITY**  
**WASTM C566/D2216/D2937 or AASHTO T255/T265**

Project: Project G Proj #: S8689-06-02  
 Date Tested: 9-22-03 Lab#: CV569  
 Tested By: R. Buto and F. Thomsen Checked By: GL

Sample #	B6-3	Sample #	B7-2.5	Sample #	B7-6	Sample #	B7-11
Tare #		Tare #		Tare #		Tare #	
Tare wt	33.4	Tare wt	32.3	Tare wt	45.4	Tare wt	32.9
Wet wt+tare	957.2	Wet wt+tare	871.2	Wet wt+tare	682.4	Wet wt+tare	840.2
Dry wt + tare	835.4	Dry wt + tare	712.9	Dry wt + tare	565.1	Dry wt + tare	657.7
Wt of water	121.8	Wt of water	158.3	Wt of water	117.3	Wt of water	182.5
Dry wt.	802	Dry wt.	680.6	Dry wt.	519.7	Dry wt.	624.8
Height	6	Height	5.7	Height	4.24	Height	5.45
Diameter	2.4	Diameter	2.4	Diameter	2.4	Diameter	2.4
Wet Density	129.7	Wet Density	123.9	Wet Density	126.5	Wet Density	124.7
Dry Density	112.6	Dry Density	100.5	Dry Density	103.2	Dry Density	96.5
% Moisture	15.2%	% Moisture	23.3%	% Moisture	22.6%	% Moisture	29.2%

Sample #	B7-16	Sample #	B7-41	Sample #	B7-46	Sample #	B7-51
Tare #		Tare #		Tare #		Tare #	
Tare wt	118.9	Tare wt	33.5	Tare wt	34.7	Tare wt	34.1
Wet wt+tare	1027.6	Wet wt+tare	793.7	Wet wt+tare	912.4	Wet wt+tare	854.7
Dry wt + tare	871.7	Dry wt + tare	525.2	Dry wt + tare	723.4	Dry wt + tare	702
Wt of water	155.9	Wt of water	268.5	Wt of water	189	Wt of water	152.7
Dry wt.	752.8	Dry wt.	491.7	Dry wt.	688.7	Dry wt.	667.9
Height	5.98	Height	6	Height	6	Height	5.34
Diameter	2.4	Diameter	2.4	Diameter	2.4	Diameter	2.4
Wet Density	128.0	Wet Density	106.7	Wet Density	123.2	Wet Density	129.4
Dry Density	106.0	Dry Density	69.0	Dry Density	96.7	Dry Density	105.3
% Moisture	20.7%	% Moisture	54.6%	% Moisture	27.4%	% Moisture	22.9%

Material Descriptions: (Depth, Location, Source, Classification, etc.)

Sample #	B6-3	Clayey Sand - Dark Greyish Brown 4/2 10yr
Sample #	B7-2.5	Clay - Dark Yellowish Brown 4/4 10yr
Sample #	B7-6	Clay - Yellowish Brown 5/4 10yr
Sample #	B7-11	Clay - Yellowish Brown 5/6 10yr
Sample #	B7-16	Clay with Sand - Brown 5/607.5yr
Sample #	B7-41	Clay with Sand - Dark Bluish Grey 3/1 Gley 2
Sample #	B7-46	Clay with Sand - Dark Greenish Grey 5/1 Gley 2
Sample #	B7-51	Clay - Dark Bluish Grey 4/1 Gley 1

C566/T255 Nominal Max Size of Agg.	D2216 Min. Mass	T265 Max Part Size	Notes:
#4 500g	#10 20g	#40 10g	Wet Density=Wet Wt/453.6/vol of tube Dry Density=Wet Density/1+ Moisture % Volume of tube= 3.14159(r <sub>s</sub> )h = inches. inches./1728 ft <sup>3</sup> = volume
3/8" 1500g	#4 100g	#4 100g	
1/2" 2000g	3/8" 500g	1/2" 300g	
3/4" 3000g	3/4" 2500g	1" 500g	
1" 4000g	1 1/2" 10kg	2" 1000g	
1 1/2" 6000g	3" 50kg		

**GEOCON Inc.**

**WATER CONTENT / DRY DENSITY**

ASTM C566/D2216/D2937 or AASHTO T255/T265

Project: Project G Proj #: S8689-06-02  
 Date Tested: 9-22-03 Lab #: CV569  
 Tested By: R. Buto and F. Thomsen Checked By: GL

Sample #	B8-6	Sample #	B9-3	Sample #	B9-6	Sample #	B9-11
Tare #		Tare #		Tare #		Tare #	
Tare wt	118.1	Tare wt	117.7	Tare wt	119.6	Tare wt	118.2
Wet wt+tare	1016	Wet wt+tare	717.8	Wet wt+tare	929.3	Wet wt+tare	667.7
Dry wt + tare	868.6	Dry wt + tare	599.1	Dry wt + tare	783.4	Dry wt + tare	548.9
Wt of water	147.4	Wt of water	118.7	Wt of water	145.9	Wt of water	118.8
Dry wt.	750.5	Dry wt.	481.4	Dry wt.	663.8	Dry wt.	430.7
Height	5.73	Height	4.08	Height	5.23	Height	4.17
Diameter	2.4	Diameter	2.4	Diameter	2.4	Diameter	2.4
Wet Density	132.0	Wet Density	123.9	Wet Density	130.4	Wet Density	111.0
Dry Density	110.3	Dry Density	99.4	Dry Density	106.9	Dry Density	87.0
% Moisture	19.6%	% Moisture	24.7%	% Moisture	22.0%	% Moisture	27.6%

Sample #	B10-3	Sample #	B10-6	Sample #	B10-14.5	Sample #	B11-3
Tare #		Tare #		Tare #		Tare #	
Tare wt	117.5	Tare wt	118.8	Tare wt	32.1	Tare wt	33.6
Wet wt+tare	1033.4	Wet wt+tare	1031.3	Wet wt+tare	892.8	Wet wt+tare	605.1
Dry wt + tare	868.2	Dry wt + tare	860.2	Dry wt + tare	753.1	Dry wt + tare	479.8
Wt of water	165.2	Wt of water	171.1	Wt of water	139.7	Wt of water	125.3
Dry wt.	750.7	Dry wt.	741.4	Dry wt.	721	Dry wt.	446.2
Height	6	Height	6	Height	5.37	Height	4.09
Diameter	2.4	Diameter	2.4	Diameter	2.4	Diameter	2.4
Wet Density	128.5	Wet Density	128.1	Wet Density	135.0	Wet Density	117.7
Dry Density	105.4	Dry Density	104.1	Dry Density	113.1	Dry Density	91.9
% Moisture	22.0%	% Moisture	23.1%	% Moisture	19.4%	% Moisture	28.1%

**Material Descriptions:** (Depth, Location, Source, Classification, etc.)

Sample #	B8-6	Clayey Sand - Very Dark Greyish Brown 3/2 10yr
Sample #	B9-3	Sandy Clay - Greyish Brown 4/4 10yr
Sample #	B9-6	Clayey Sand - Dark Yellowish Brown 4/4 10yr
Sample #	B9-11	Clay with Sand - Dark Bluish Grey 4/1 Gley 2
Sample #	B10-3	Clayey Sand - Yellowish Brown 5/3 10yr
Sample #	B10-6	Clayey Sand - Greyish Brown 5/2 10yr
Sample #	B10-14.5	Clayey Sand - Dark Greenish Grey 3/1 Gley 1
Sample #	B11-3	Clay - Yellowish Brown 5/4 10yr

C566/T255 Nominal Max Size of Agg.	D2216 Min. Mass	T265 Max Part Size	Notes:
#4 500g	#10 20g	#40 10g	Wet Density=Wet Wt/453.6/vol of tube Dry Density=Wet Density/1+ Moisture % Volume of tube= 3.14159(r)h = inches. inches./1728 ft. = volume
3/8" 1500g	#4 100g	#4 100g	
1/2" 2000g	3/8" 500g	1/2" 300g	
3/4" 3000g	3/4" 2500g	1" 500g	
1" 4000g	1 1/2" 10kg	2" 1000g	
1 1/2" 5000g	3" 50kg		

**WATER CONTENT / DRY DENSITY**

ASTM C566/D2216/D2937 or AASHTO T255/T265

Project: Project G	Proj.#: S8689-06-02
Date Tested: 9-22-03	Lab#: CV569
Tested By: R. Buto and F. Thomsen	Checked By: GL

Sample #	B11-6	Sample #	B11-14.5	Sample #		Sample #	
Tare #		Tare #		Tare #		Tare #	
Tare wt	213.3	Tare wt	185.9	Tare wt		Tare wt	
Wet wt+tare	1057.8	Wet wt+tare	991.9	Wet wt+tare		Wet wt+tare	
Dry wt + tare	873.9	Dry wt + tare	776.5	Dry wt + tare		Dry wt + tare	
Wt of water	183.9	Wt of water	215.4	Wt of water	0	Wt of water	0
Dry wt.	660.6	Dry wt.	590.6	Dry wt.	0	Dry wt.	0
Height	5.68	Height	5.67	Height		Height	
Diameter	2.4	Diameter	2.4	Diameter		Diameter	
Wet Density	125.2	Wet Density	119.7	Wet Density	#DIV/0!	Wet Density	#DIV/0!
Dry Density	97.9	Dry Density	87.7	Dry Density	#DIV/0!	Dry Density	#DIV/0!
% Moisture	27.8%	% Moisture	36.5%	% Moisture	#DIV/0!	% Moisture	#DIV/0!

Sample #		Sample #		Sample #		Sample #	
Tare #		Tare #		Tare #		Tare #	
Tare wt		Tare wt		Tare wt		Tare wt	
Wet wt+tare		Wet wt+tare		Wet wt+tare		Wet wt+tare	
Dry wt + tare		Dry wt + tare		Dry wt + tare		Dry wt + tare	
Wt of water	0	Wt of water	0	Wt of water	0	Wt of water	0
Dry wt.	0	Dry wt.	0	Dry wt.	0	Dry wt.	0
Height		Height		Height		Height	
Diameter		Diameter		Diameter		Diameter	
Wet Density	#DIV/0!	Wet Density	#DIV/0!	Wet Density	#DIV/0!	Wet Density	#DIV/0!
Dry Density	#DIV/0!	Dry Density	#DIV/0!	Dry Density	#DIV/0!	Dry Density	#DIV/0!
% Moisture	#DIV/0!	% Moisture	#DIV/0!	% Moisture	#DIV/0!	% Moisture	#DIV/0!

**Material Descriptions:** (Depth, Location, Source, Classification, etc.)

Sample #	B11-6	Clay - Dark Yellowish Brown 4/6 10yr
Sample #	B11-14.5	Clay - Dark Greenish Grey 3/1 Gley 1
Sample #		
Sample #		
Sample #		
Sample #		
Sample #		

C566/T255 Nominal Max Size of Agg.		D2216 Min. Mass		T265 Max Part Size		Notes:
#4	500g	#10	20g	#40	10g	
3/8"	1500g	#4	100g	#4	100g	
1/2"	2000g	3/8"	500g	1/2"	300g	
3/4"	3000g	3/4"	2500g	1"	500g	
1"	4000g	1 1/2"	10kg	2"	1000g	
1 1/2"	6000g	3"	50kg			

# LIQUID AND PLASTIC LIMITS TEST REPORT

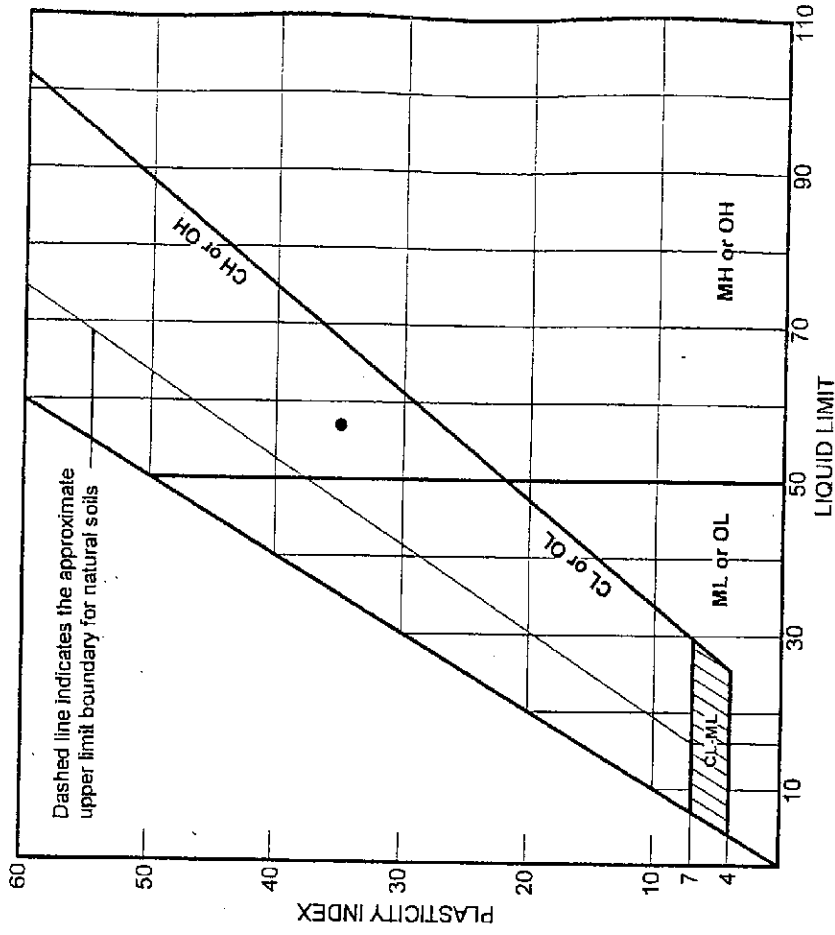
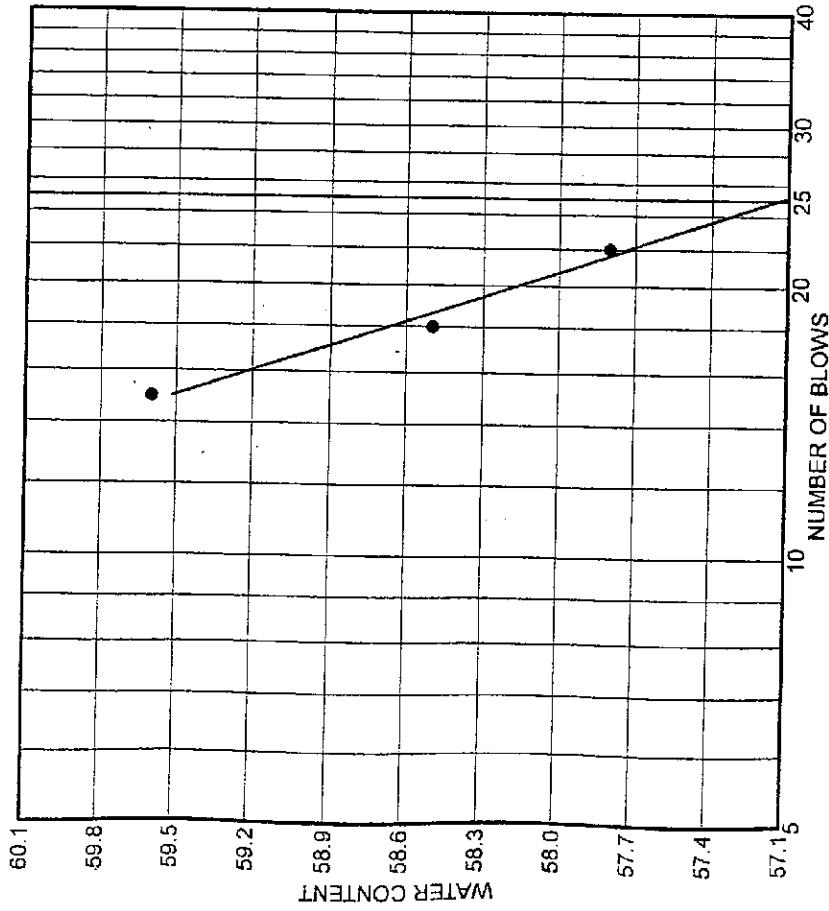

SOURCE	DEPTH/ELEV.	DATE SAMPLED	USCS	MATERIAL DESCRIPTION	NM %	LL	PI
• BI-B11	15.5	9-17	CH	Fat Clay		57	35

Client: •

Project: Project "G"

Project No. S8689-06-02 Figure

GEOCON CONSULTANTS, INC.

# LIQUID AND PLASTIC LIMITS TEST REPORT

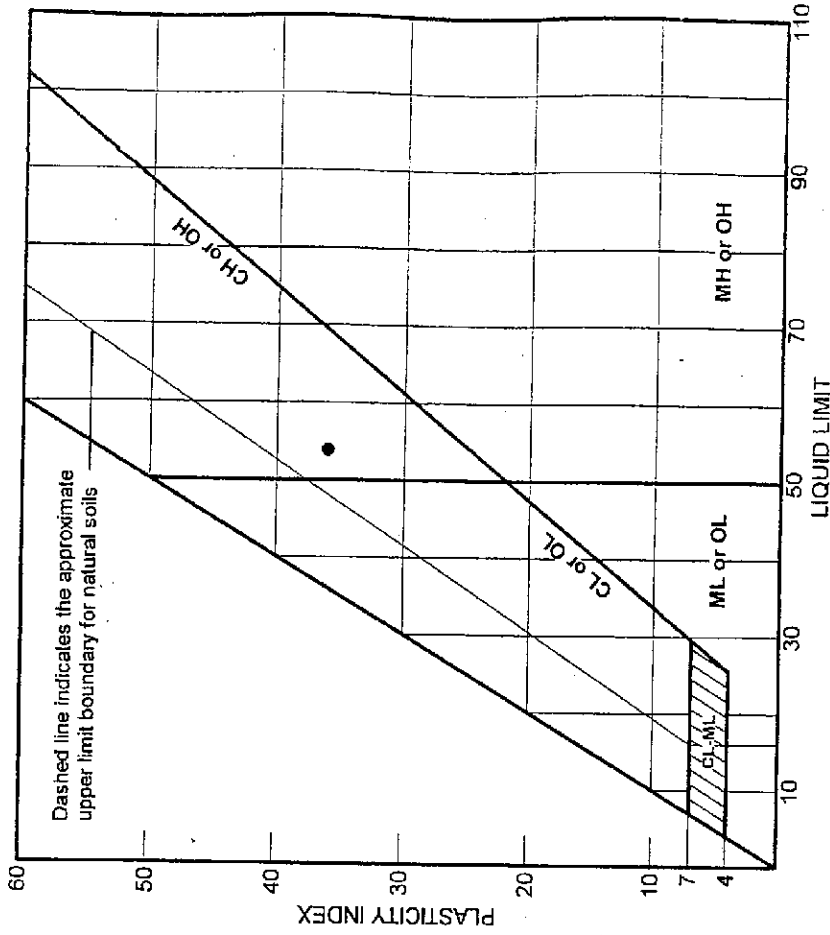
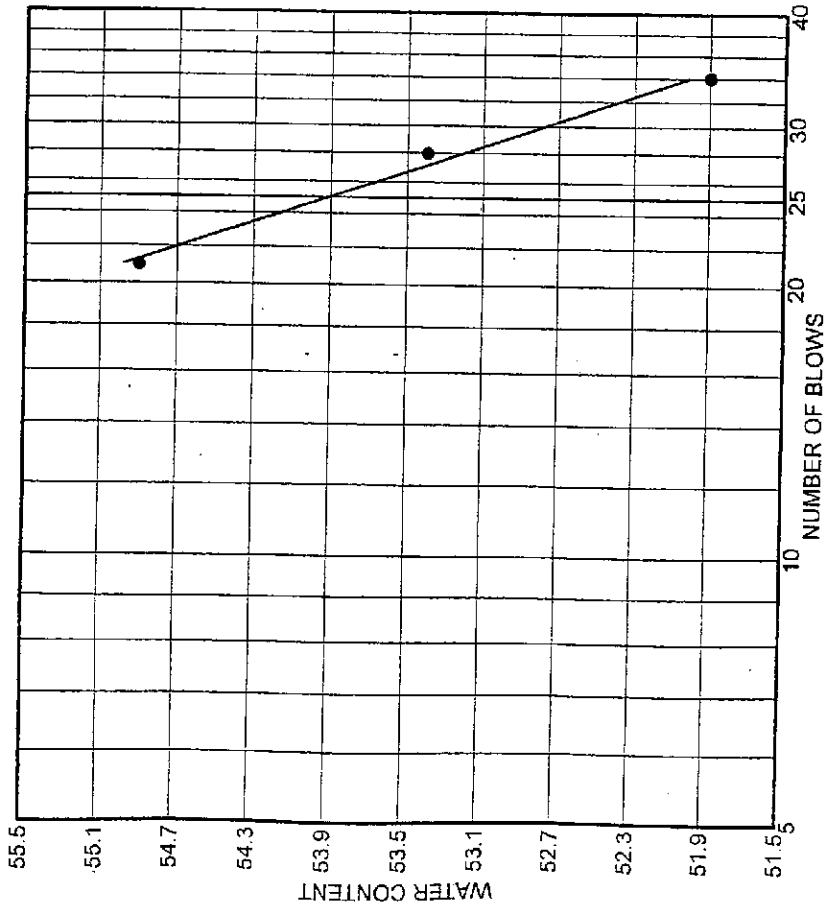

SOURCE	SAMPLE #	DEPTH/ELEV.	DATE SAMPLED	USCS	MATERIAL DESCRIPTION	NM %	LL	PI
B1-B11	B6-5	5	9-18	CH	Fat Clay	30.4	54	36

Client: •

Project: Project "G"

Project No. S8689-06-02 Figure

**GEOCON CONSULTANTS, INC.**

# LIQUID AND PLASTIC LIMITS TEST REPORT

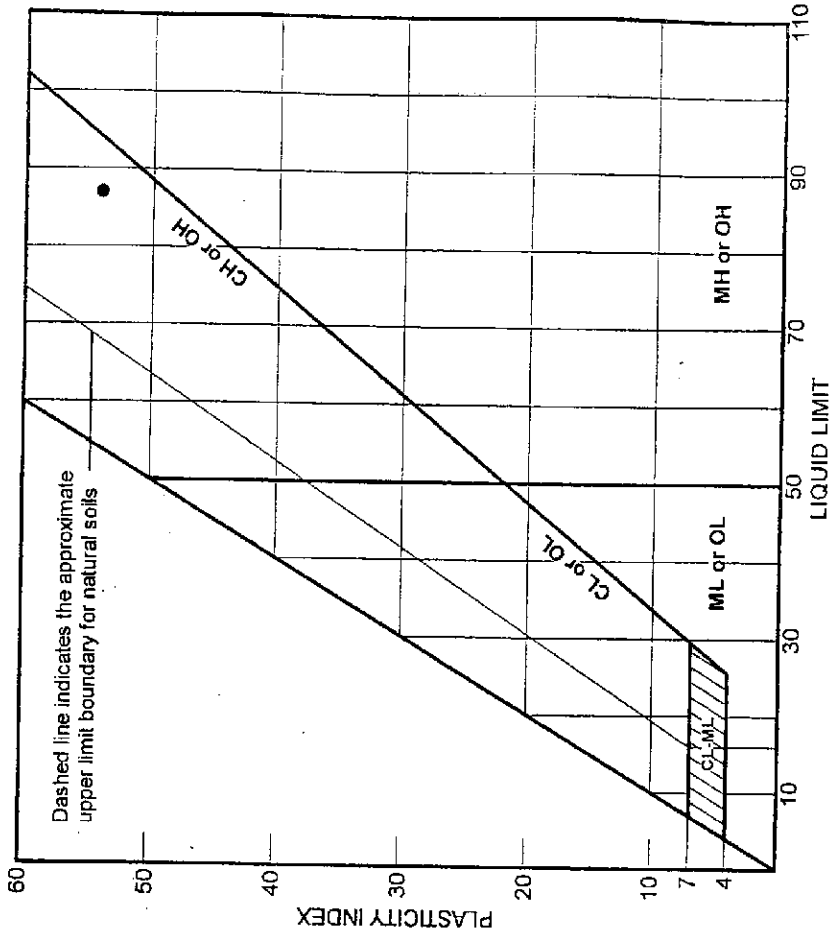
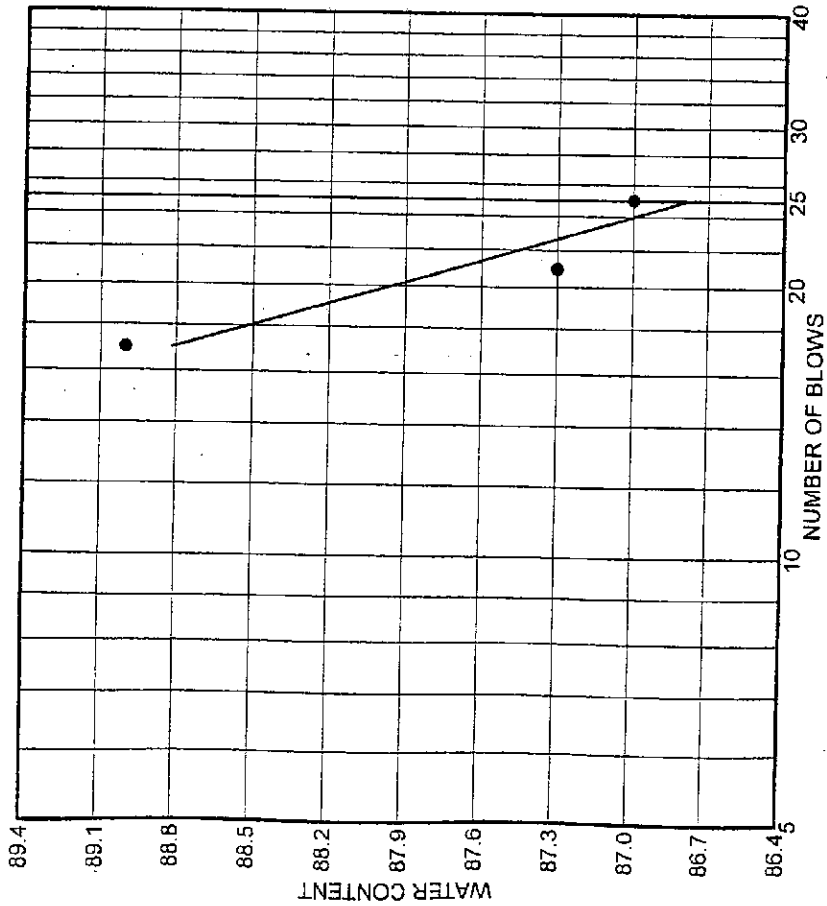

SOURCE	DEPTH/ELEV.	DATE SAMPLED	USCS	MATERIAL DESCRIPTION	NM %	LL	PI
B1-B11	20.5	9-17	CH	Fat Clay		87	54

Client \_\_\_\_\_

Project "G" \_\_\_\_\_

Project No. S8689-06-02 \_\_\_\_\_ Figure \_\_\_\_\_

**GEOCON CONSULTANTS, INC.**

# LIQUID AND PLASTIC LIMITS TEST REPORT

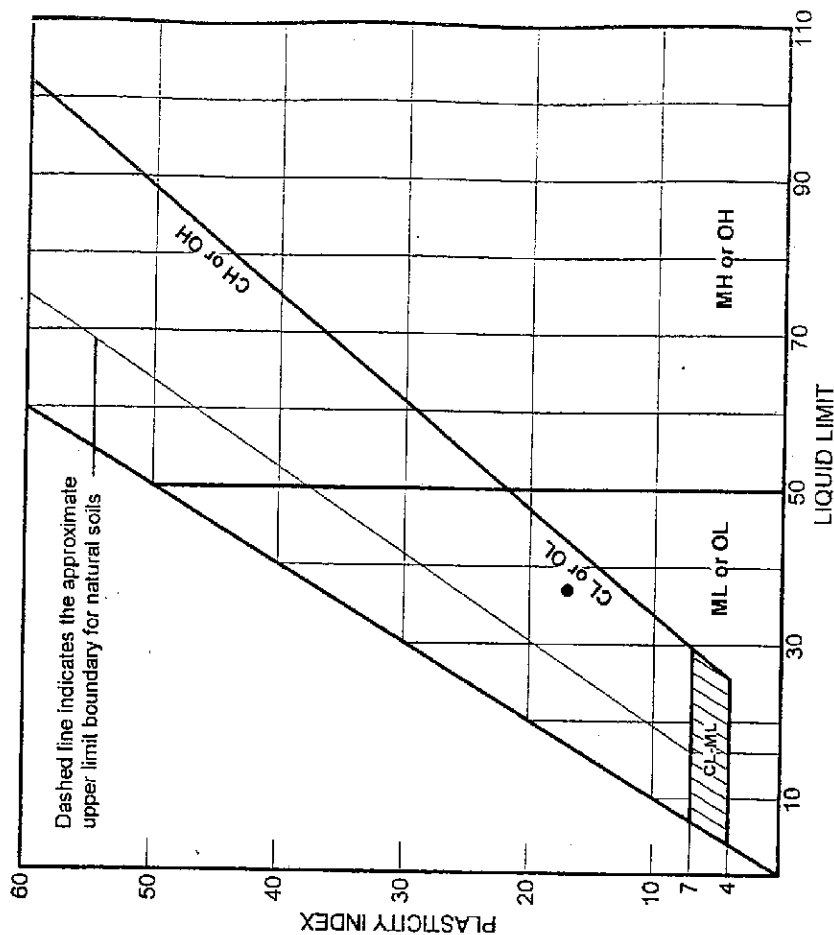
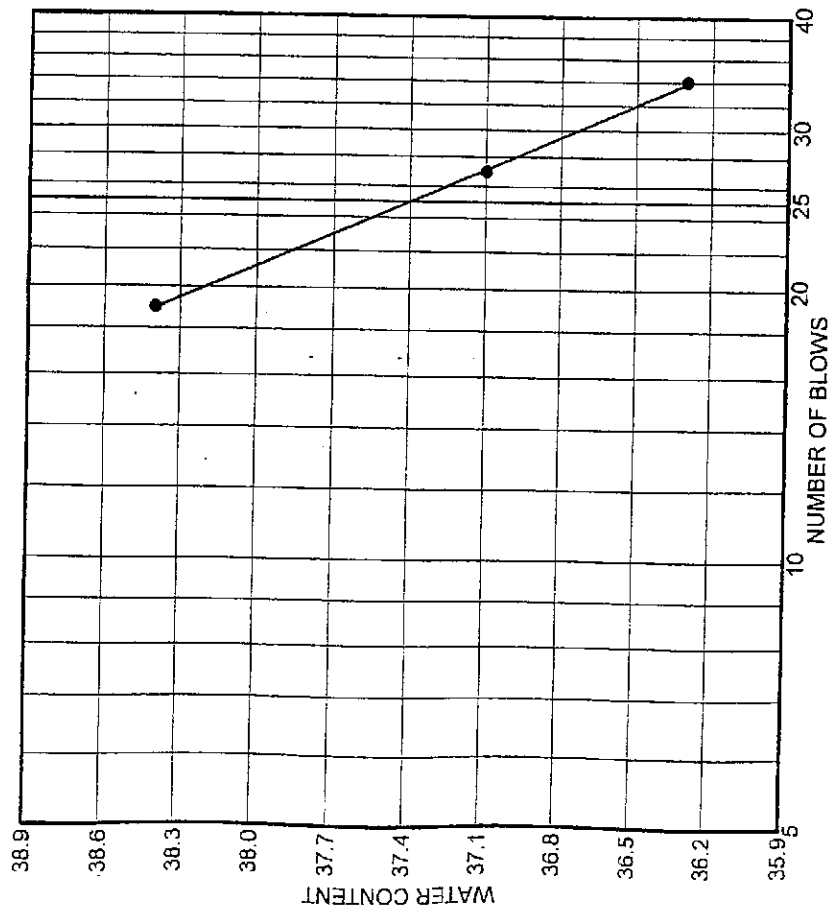

SOURCE	DEPTH/ELEV.	DATE SAMPLED	USCS	MATERIAL DESCRIPTION	NM %	LL	PI
● B1-B11	B4-10	9-18	CL	Lean Clay		37	17

Client \_\_\_\_\_

Project Project "G"

Project No. S8689-06-02 Figure

GEOCON CONSULTANTS, INC.

# LIQUID AND PLASTIC LIMITS TEST REPORT

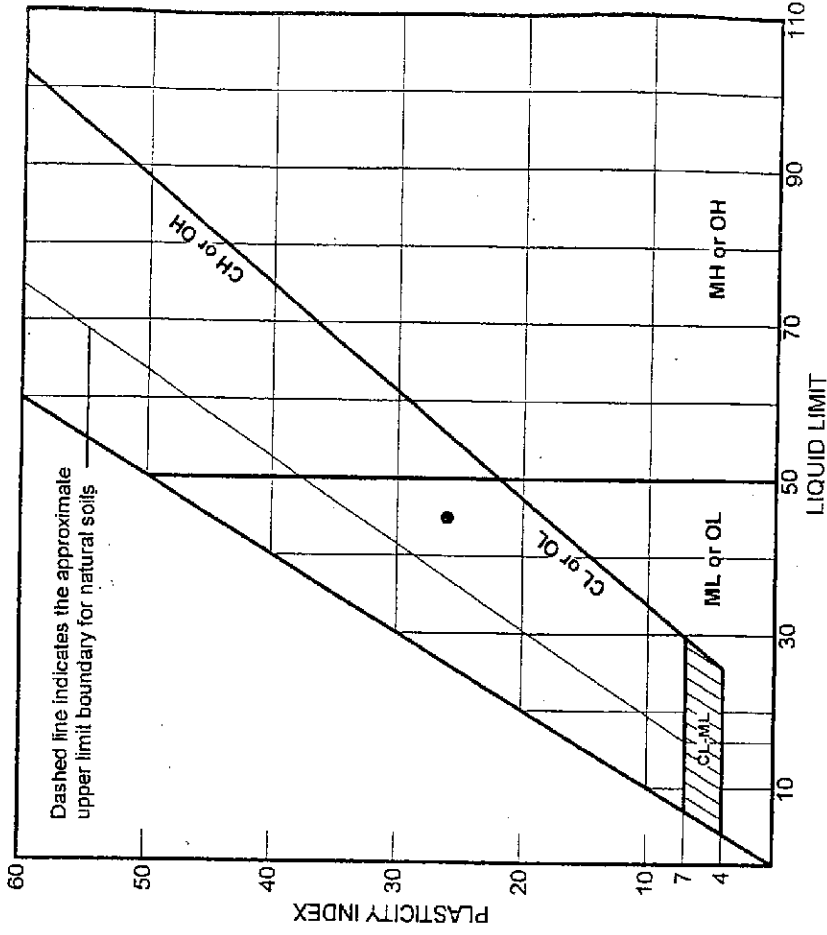
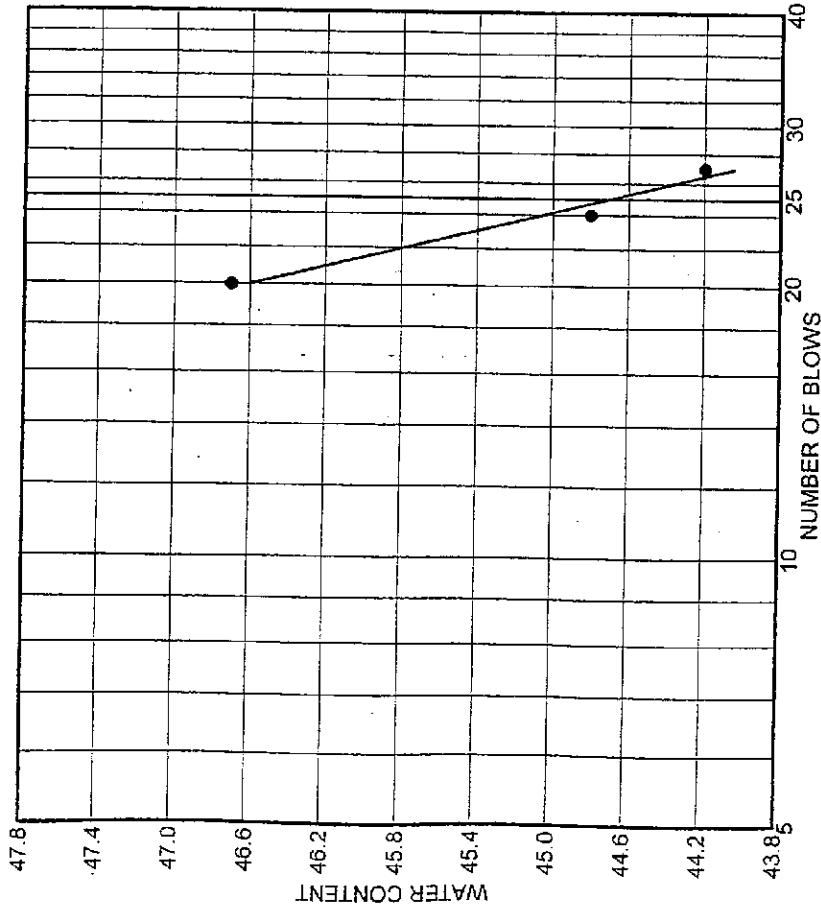

SOURCE	DEPTH/ELEV.	DATE SAMPLED	USCS	MATERIAL DESCRIPTION	NM %	LL	PI
● BI-B11	13.5	9-17	CL	Lean Clay	34.4	45	26

Client	●
Project "G"	
<b>GEOCON CONSULTANTS, INC.</b>	
Project No. S8689-06-02	Figure



# LIQUID AND PLASTIC LIMITS TEST REPORT

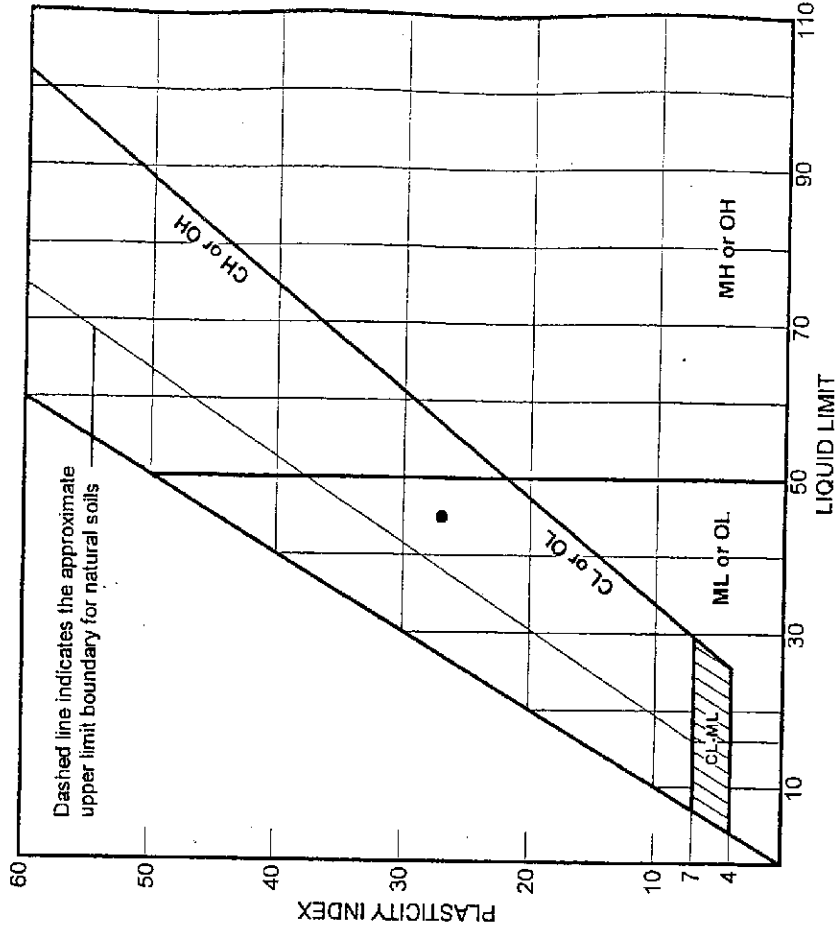
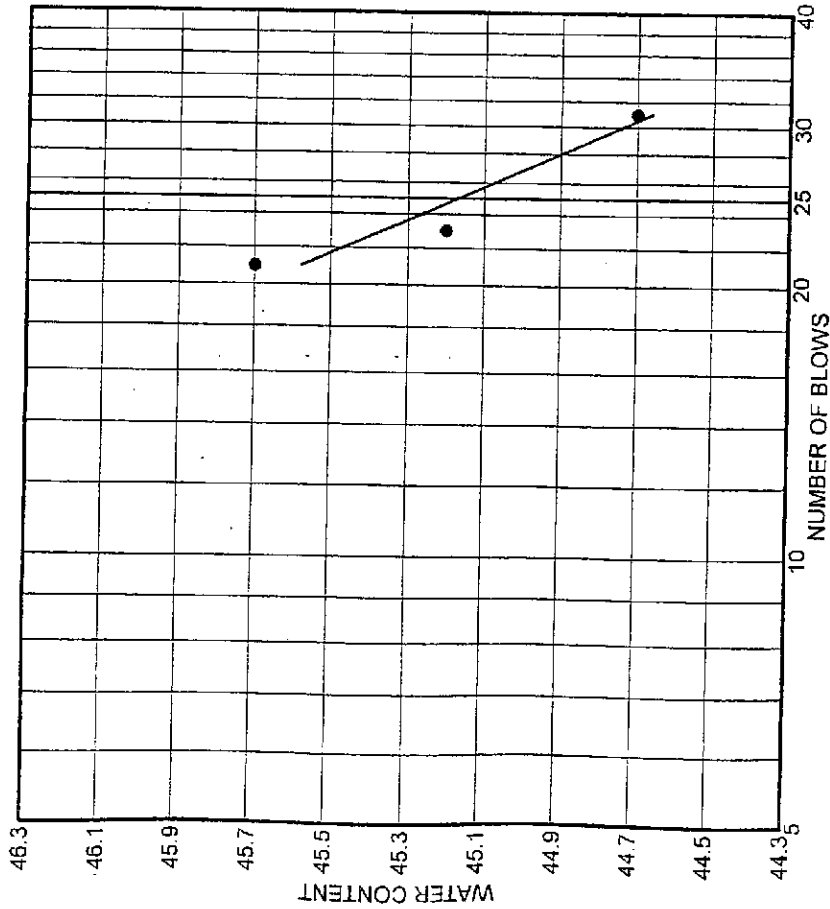

SOURCE	DEPTH/ELEV.	DATE SAMPLED	USCS	MATERIAL DESCRIPTION	NM %	LL	PI
B1-B11	8	9-22	CL	Lean Clay	23.8	45	27

Client \_\_\_\_\_

Project Project "G"

Project No. S8689-06-02 Figure

GEOCON CONSULTANTS, INC.

# LIQUID AND PLASTIC LIMITS TEST REPORT

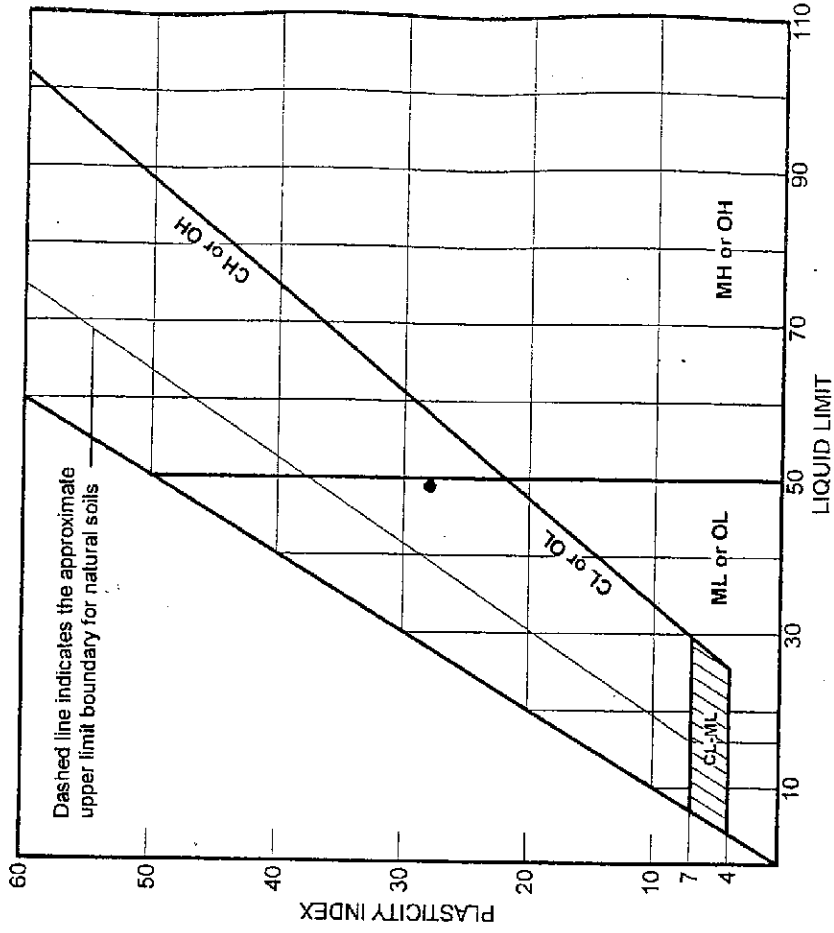
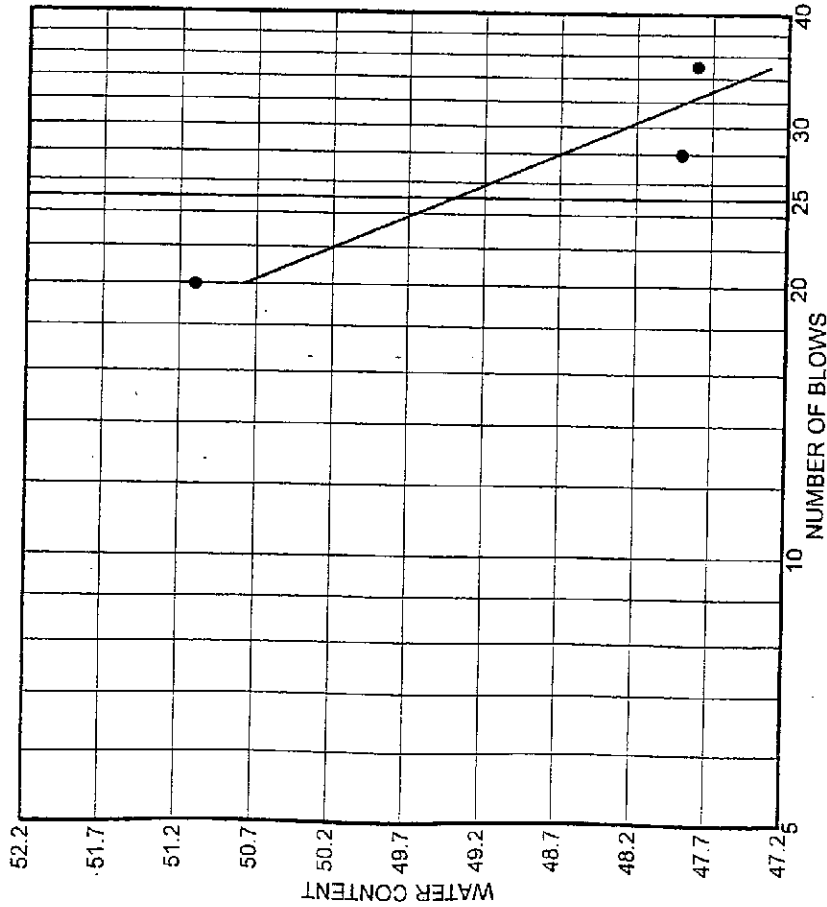

SOURCE	SAMPLE #	DEPTH/ELEV.	DATE SAMPLED	USCS	MATERIAL DESCRIPTION	NM %	LL	PI
B1-B11	B8-14	14	9-22	CL	Lean Clay	34.9	49	28

Client \_\_\_\_\_

Project Project "G"

Project No. S8689-06-02 Figure

**GEOCON CONSULTANTS, INC.**

# LIQUID AND PLASTIC LIMITS TEST REPORT

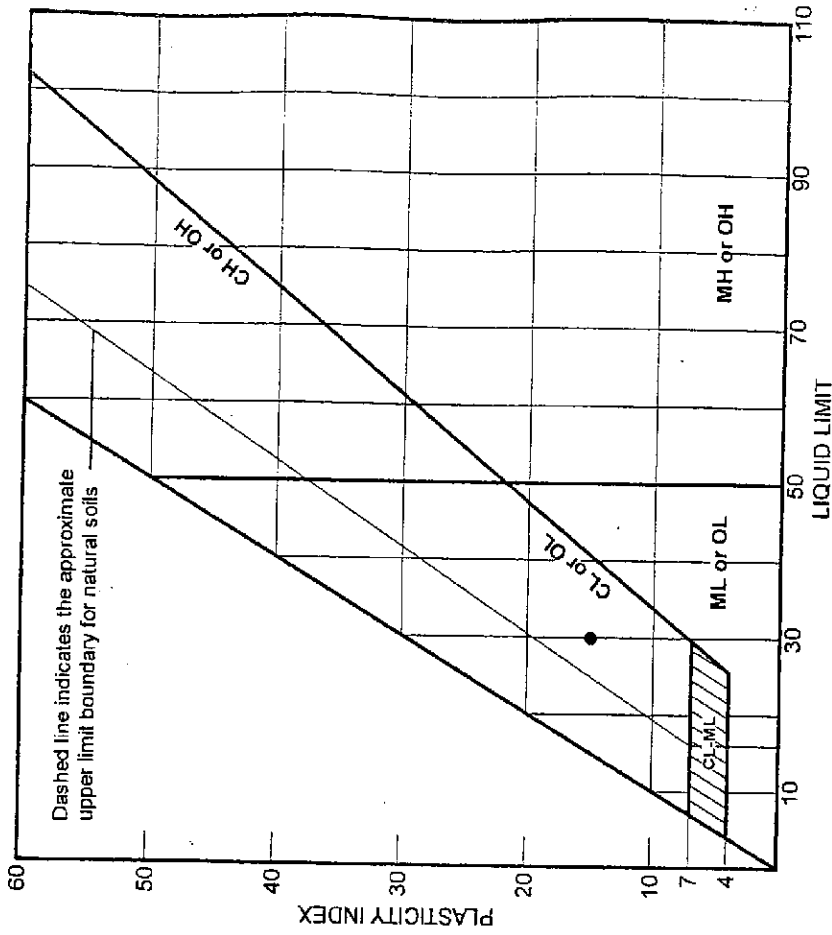
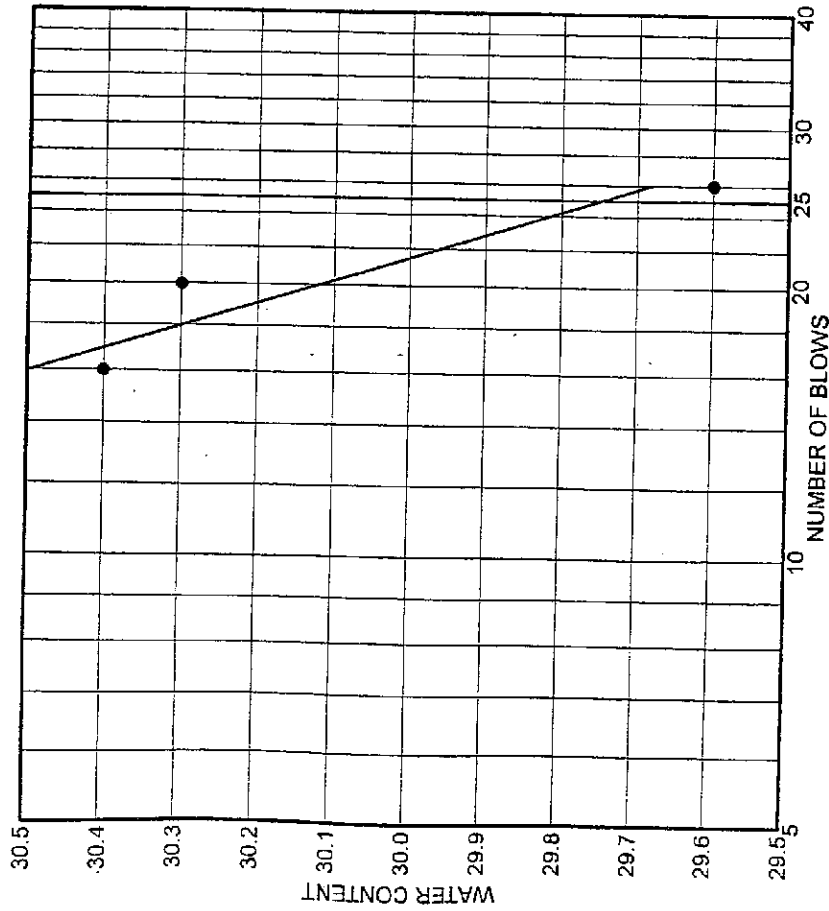

SOURCE	SAMPLE #	DEPTH/ELEV.	DATE SAMPLED	USCS
B1-B11	B10-6.5	6.5	9-22	CL

MATERIAL DESCRIPTION	NM %	LL	PI
Sandy Lean CLAY	21.4	30	15

Client

Project Project "G"

**GEOCON CONSULTANTS, INC.**

Project No. S8689-06-02

Figure

# LIQUID AND PLASTIC LIMITS TEST REPORT

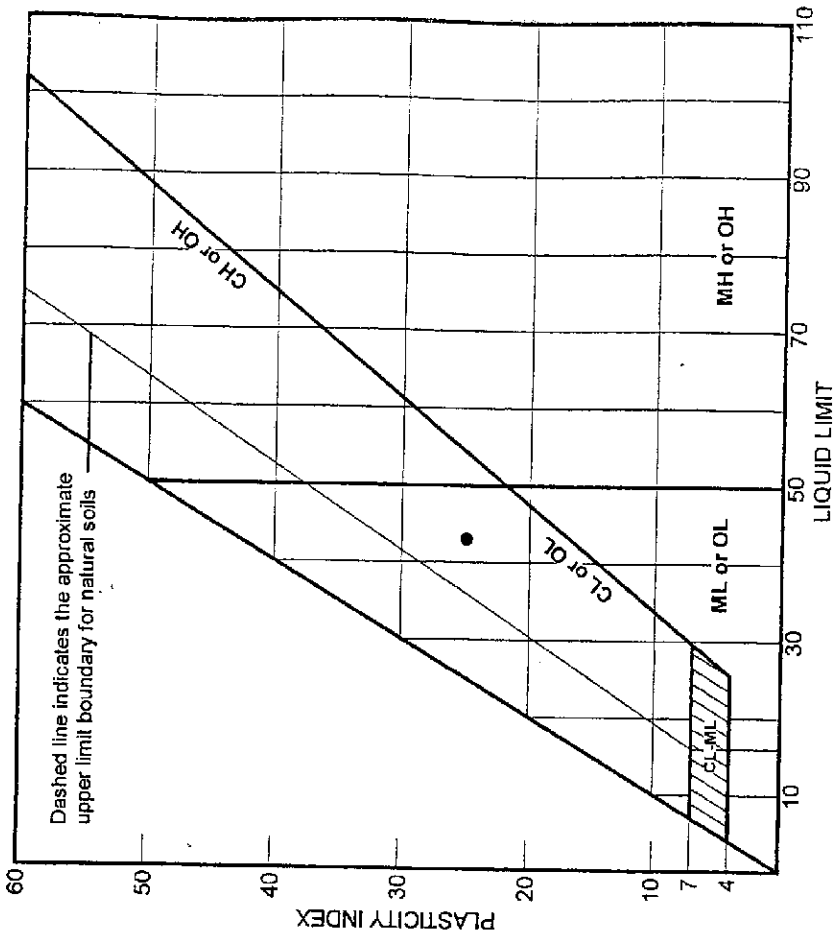
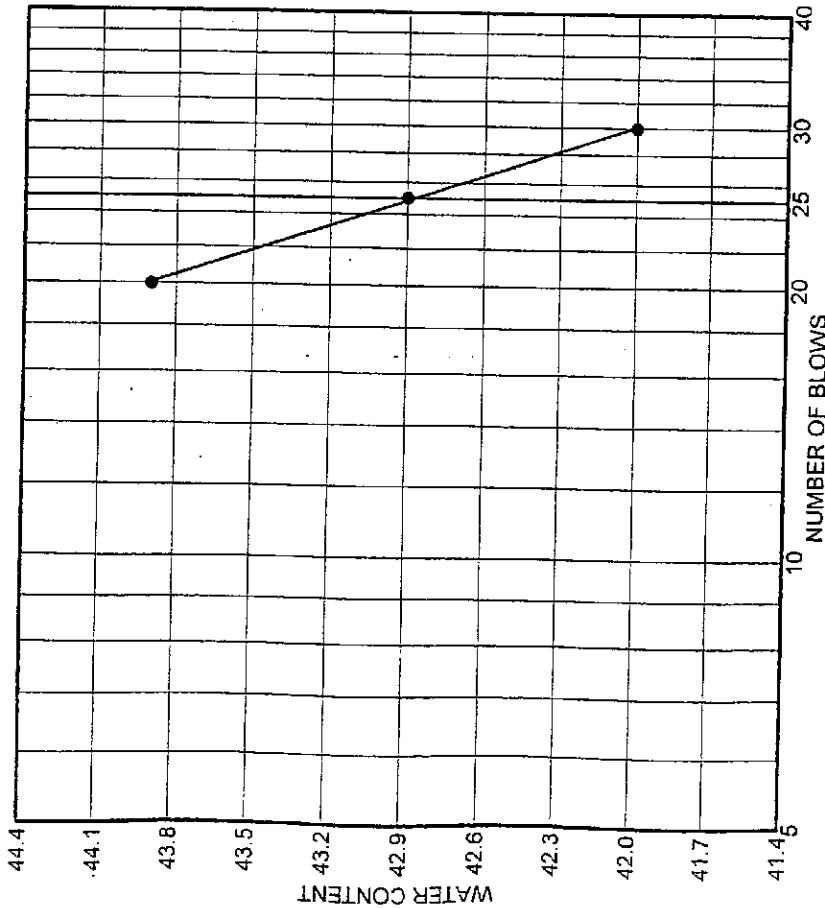

SOURCE	SAMPLE #	DEPTH/ELEV.	DATE SAMPLED	USCS	MATERIAL DESCRIPTION	NM %	LL	PI
•	BI-B11	7	9-22	CL	Lean CLAY	22.6	43	25

Client \_\_\_\_\_

Project Project "G"

Project No. S8689-06-02 Figure \_\_\_\_\_

**GEOCON CONSULTANTS, INC.**

# Particle Size Distribution Report

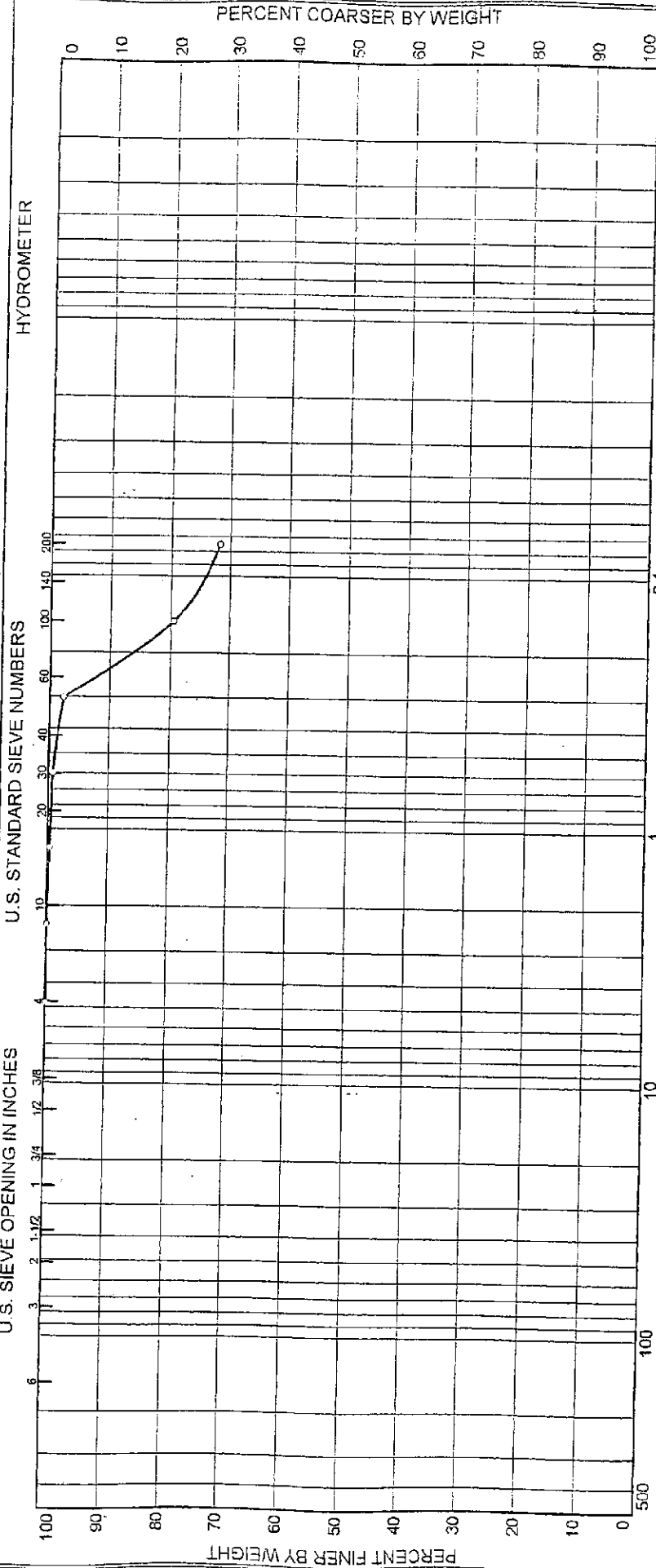

<b>% COBBLES</b>	0.0	<b>% GRAVEL</b>	0.0	<b>% SAND</b>	28.3
				<b>% SILT</b>	71.7
				<b>% CLAY</b>	

SOURCE	SAMPLE #	DEPTH/ELEV.	DATE SAMPLED	USCS	MATERIAL DESCRIPTION	NM %	LL	PL
B1-B11	B1-10.5	10.5	9-25-03	CL	Lean Clay with sand			

**Client** \_\_\_\_\_

**Project** Project "G"

**Project No.** S8689-46-02      **Figure** \_\_\_\_\_

**GEOCON CONSULTANTS, INC.**

---

---

GRAIN SIZE DISTRIBUTION TEST DATA

---

Client:

Project: Project "G"

Project Number: S8689-06-02

---

Sample Data

---

Source: B1-B11

Sample No.: B1-10.5

Elev. or Depth: 10.5

Sample Length (in./cm.):

Location:

Description: Lean Clay with sand

Date: 9-25-03

Natural Moisture:

Liquid Limit:

Plastic Limit:

USCS Class.: CL

Testing Remarks:

---

Mechanical Analysis Data

---

	Initial	After wash
Dry sample and tare=	794.30	341.00
Tare =	159.10	159.10
Dry sample weight =	635.20	181.90
Minus #200 from wash=	71.4 %	
Tare for cumulative weight retained=	.00	

Sieve	Cumul. Wt. retained	Percent finer
# 4	0.00	100.0
# 8	0.40	99.9
# 16	1.70	99.7
# 30	4.30	99.3
# 50	14.40	97.7
# 100	130.00	79.5
# 200	179.80	71.7

---

Fractional Components

---

Gravel/Sand based on #4

Sand/Fines based on #200

% COBBLES =

% GRAVEL =

% SAND = 28.3

% FINES = 71.7

D<sub>85</sub> = 0.19

# Particle Size Distribution Report

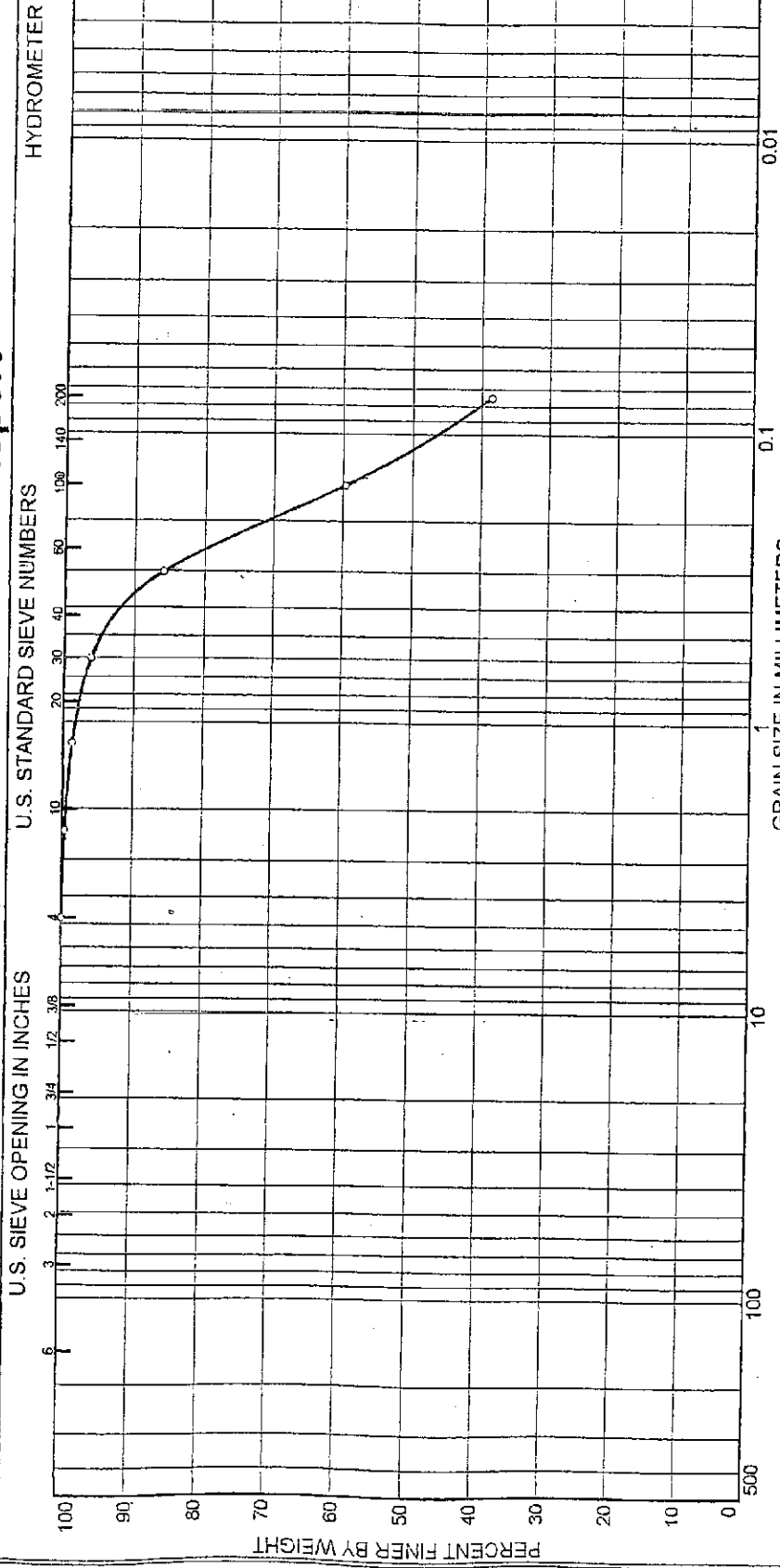

% COBBLES	0.0	% GRAVEL	0.0	% SAND	61.5
			% SILT		38.5
			% CLAY		

SOURCE	DEPTH/ELEV.	DATE SAMPLED	USCS	MATERIAL DESCRIPTION
B1-B11	10.5	9-25-03	SC	Clayey SAND
		NM %	LL	PL

Client: \_\_\_\_\_

Project: Project "G"

**GEOCON CONSULTANTS, INC.**

Project No. S8689-06-02      Figure

---

GRAIN SIZE DISTRIBUTION TEST DATA

---

Client:

Project: Project "G"

Project Number: S8689-06-02

---

Sample Data

---

Source: B1-B11

Sample No.: B2-10.5

Elev. or Depth: 10.5

Location:

Description: Clayey SAND

Date: 9-25-03

Liquid Limit:

Testing Remarks:

Sample Length (in./cm.):

Natural Moisture:

Plastic Limit:

USCS Class.: SC

---

Mechanical Analysis Data

---

	Initial	After wash
Dry sample and tare=	849.10	585.60
Tare =	156.20	156.20
Dry sample weight =	692.90	429.40
Minus #200 from wash=	38.0 %	
Tare for cumulative weight retained=	.00	

Sieve	Cumul. Wt. retained	Percent finer
# 4	0.00	100.0
# 8	1.90	99.7
# 16	8.80	98.7
# 30	26.90	96.1
# 50	98.10	85.8
# 100	279.90	59.6
# 200	426.00	38.5

---

Fractional Components

---

Gravel/Sand based on #4

Sand/Fines based on #200

% COBBLES =

% GRAVEL =

% SAND = 61.5

% FINES = 38.5

D85= 0.29 D60= 0.15 D50= 0.11



# Particle Size Distribution Report

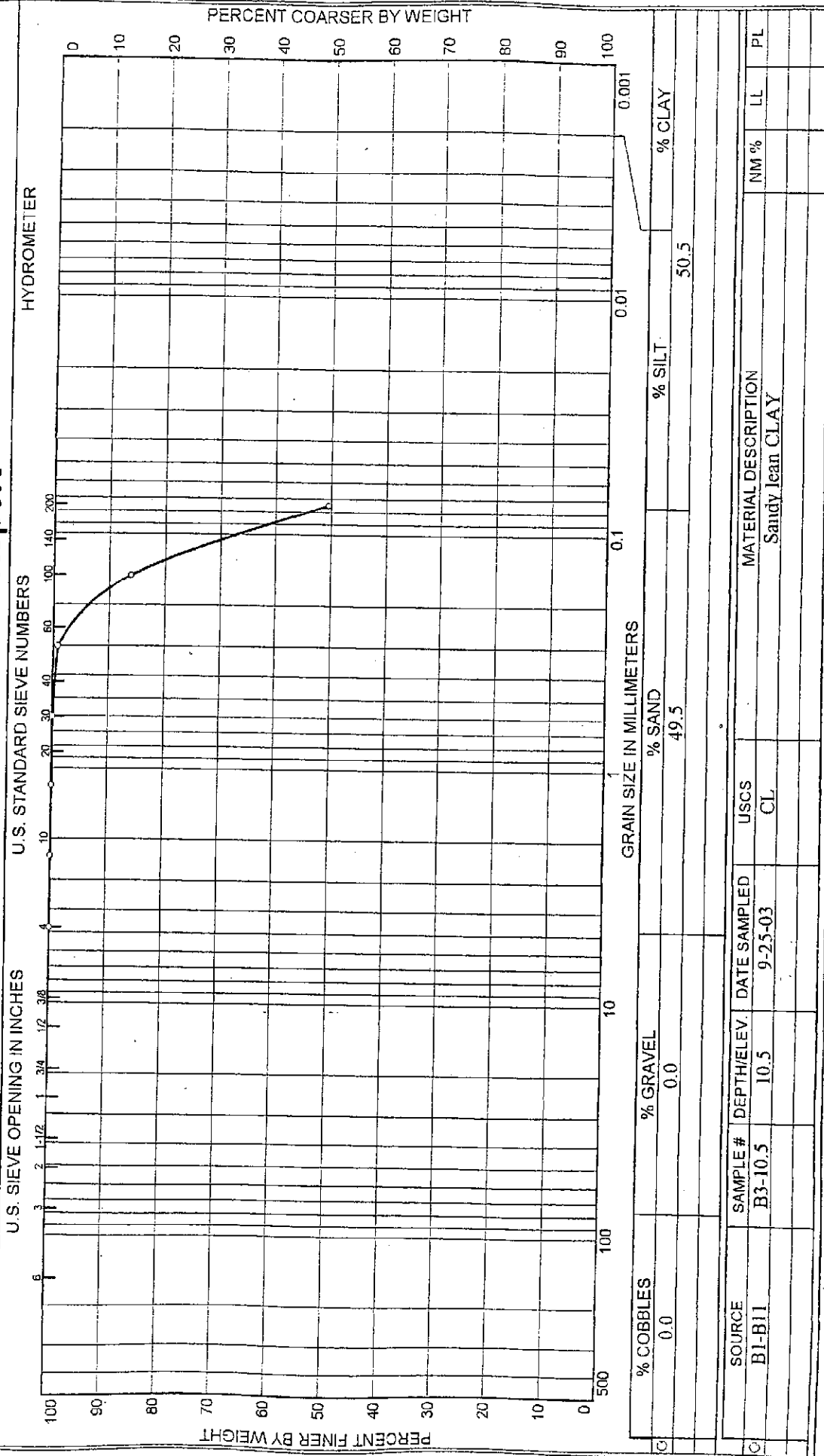

% COBBLES	0.0	% GRAVEL	0.0	% SAND	49.5	% SILT	50.5	% CLAY	0.0
SOURCE	B1-B11	DEPTH/ELEV.	10.5	DATE SAMPLED	9-25-03	USCS	CL	MATERIAL DESCRIPTION	Sandy lean CLAY
								NM %	LL
									PL
Client									
Project "G"									
<b>GEOCON CONSULTANTS, INC.</b>									
Project No. S8689-06-02									
Figure									

---

---

GRAIN SIZE DISTRIBUTION TEST DATA

---

Client:  
Project: Project "G"  
Project Number: S8689-06-02

---

Sample Data

---

Source: B1-B11  
Sample No.: B3-10.5  
Elev. or Depth: 10.5  
Location: Sample Length (in./cm.):  
Description: Sandy lean CLAY  
Date: 9-25-03 Natural Moisture:  
Liquid Limit: Plastic Limit: USCS Class.: CL  
Testing Remarks:

---

Mechanical Analysis Data

---

	Initial	After wash
Dry sample and tare=	860.90	549.00
Tare =	205.20	205.20
Dry sample weight =	655.70	343.80
Minus #200 from wash=	47.6 %	
Tare for cumulative weight retained=	.00	

Sieve	Cumul. Wt. retained	Percent finer
# 4	0.00	100.0
# 8	0.00	100.0
# 16	0.10	100.0
# 30	0.40	99.9
# 50	5.20	99.2
# 100	90.90	86.1
# 200	324.60	50.5

---

Fractional Components

---

Gravel/Sand based on #4  
Sand/Fines based on #200  
% COBBLES =                    % GRAVEL =                    % SAND = 49.5  
% FINES = 50.5

D<sub>85</sub> = 0.15    D<sub>60</sub> = 0.09

# Particle Size Distribution Report

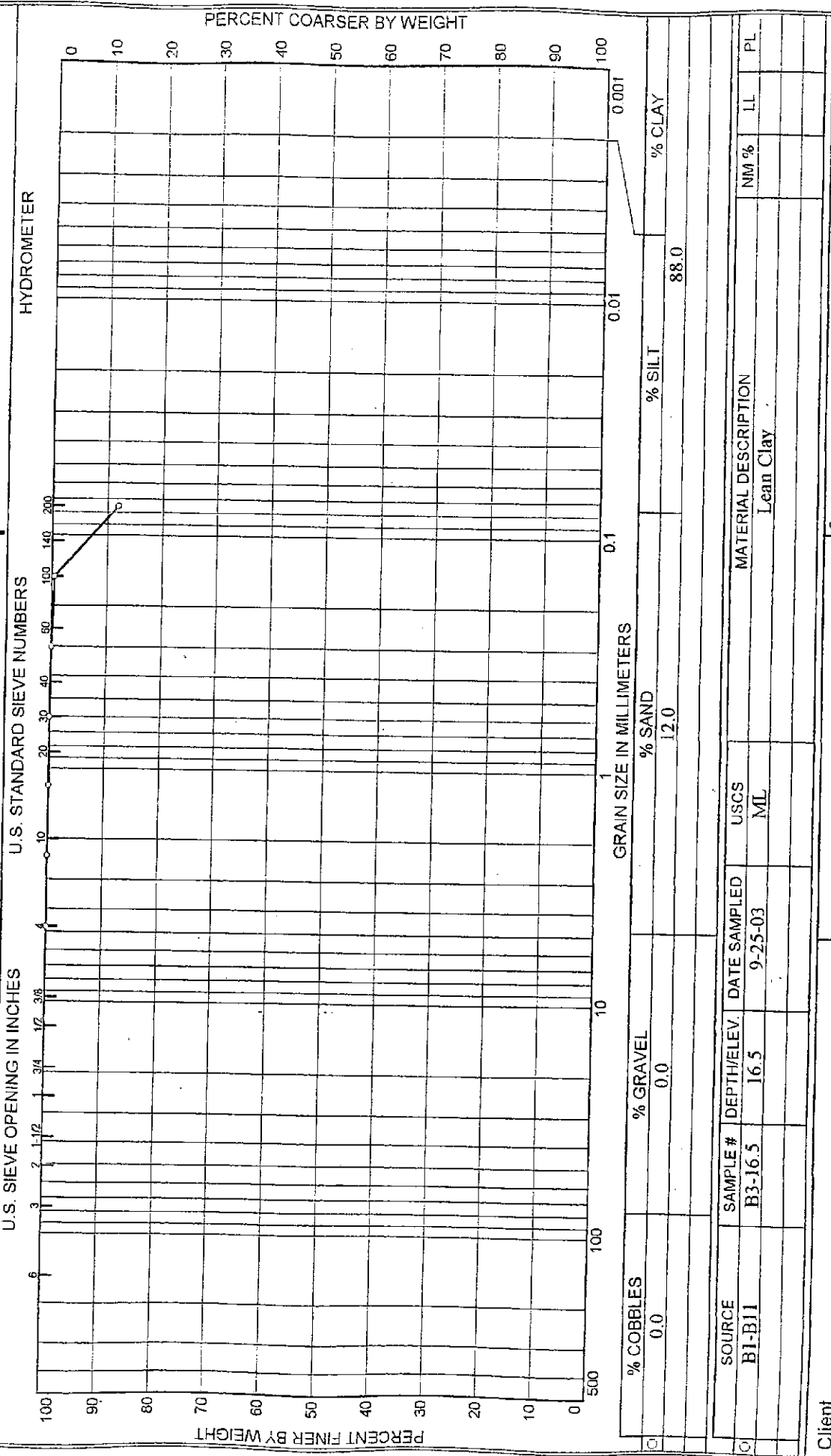

<b>% COBBLES</b>	0.0	<b>% GRAVEL</b>	0.0	<b>% SAND</b>	12.0	<b>% SILT</b>	88.0	<b>% CLAY</b>	88.0
<b>SOURCE</b>	B1-B11	<b>DEPTH/ELEV.</b>	16.5	<b>DATE SAMPLED</b>	9-25-03	<b>USCS</b>	ML	<b>MATERIAL DESCRIPTION</b>	Lean Clay
<b>NM %</b>		<b>LL</b>		<b>PL</b>					
Client									
Project "G"									
<b>GEOCON CONSULTANTS, INC.</b>									
Project No. S8689-06-02					Figure				

---

GRAIN SIZE DISTRIBUTION TEST DATA

---

Client:  
Project: Project "G"  
Project Number: S8689-06-02

---

Sample Data

---

Source: B1-B11  
Sample No.: B3-16.5  
Elev. or Depth: 16.5  
Location: Sample Length (in./cm.):  
Description: Lean Clay  
Date: 9-25-03  
Liquid Limit: Natural Moisture:  
Testing Remarks: Plastic Limit:                      USCS Class.: ML

---

Mechanical Analysis Data

---

	Initial	After wash
Dry sample and tare=	908.10	320.00
Tare =	206.80	206.80
Dry sample weight =	701.30	113.20
Minus #200 from wash=	83.9 %	
Tare for cumulative weight retained=	.00	
Sieve	Cumul. Wt. retained	Percent finer
# 4	0.00	100.0
# 8	0.00	100.0
# 16	0.00	100.0
# 30	0.10	100.0
# 50	0.80	99.9
# 100	3.20	99.5
# 200	84.00	88.0

---

Fractional Components

---

Gravel/Sand based on #4  
Sand/Fines based on #200  
% COBBLES =                      % GRAVEL =                      % SAND = 12.0  
% FINES = 88.0

# Particle Size Distribution Report

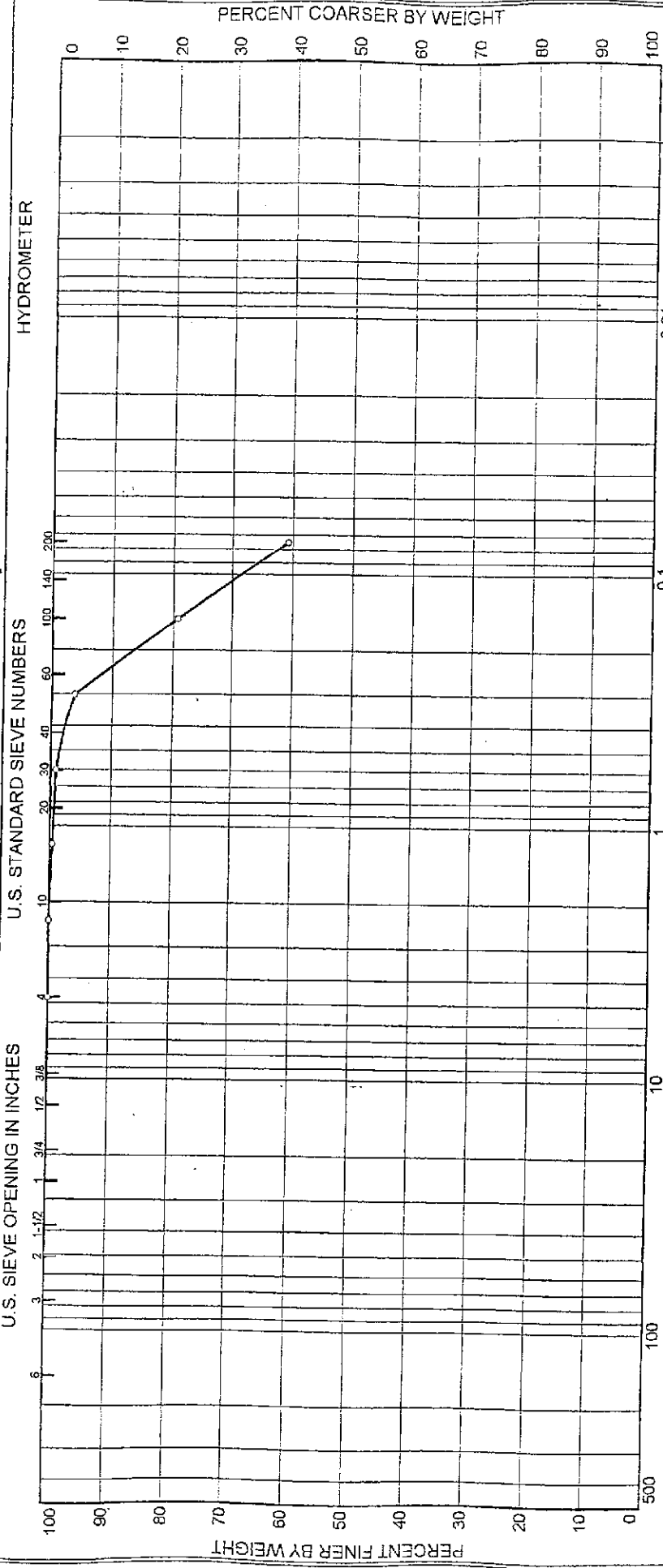

<b>% COBBLES</b>	0.0	<b>% SAND</b>	39.2
<b>% GRAVEL</b>	0.0	<b>% SILT</b>	60.8
<b>% CLAY</b>		<b>% CLAY</b>	

SOURCE	DEPTH/ELEV.	DATE SAMPLED	USCS	MATERIAL DESCRIPTION	NM %	LL	PL
B1-B11	B4-6	9-25-03	CL	Sandy lean Clay			

Client: \_\_\_\_\_

Project: Project "G"

**GEOCON CONSULTANTS, INC.**

Project No. S8089-06-02 Figure



# Particle Size Distribution Report

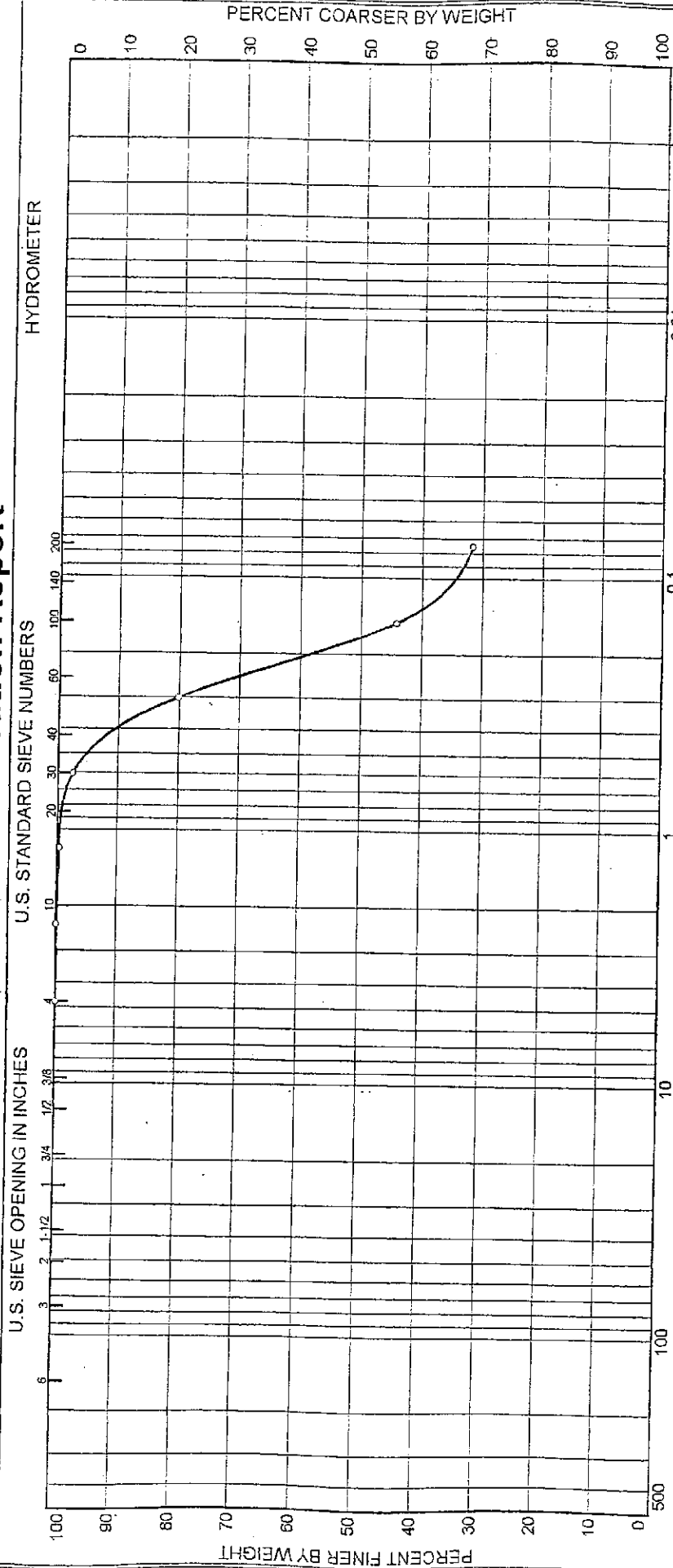

% COBBLES	0.0	% GRAVEL	0.0	% SAND	68.3	% SILT	31.7	% CLAY	0.0
-----------	-----	----------	-----	--------	------	--------	------	--------	-----

SOURCE	SAMPLE #	DEPTH/ELEV.	DATE SAMPLED	USCS	MATERIAL DESCRIPTION	NM %	LL	PL
B1-B11	B6-II	11	9-25-03	SC	clayey SAND			

Client: \_\_\_\_\_  
 Project: Project "G"  
 Project No. S8689-06-02      Figure

**GEOCON CONSULTANTS, INC.**

GRAIN SIZE DISTRIBUTION TEST DATA

Client:  
Project: Project "G"  
Project Number: S8689-06-02

Sample Data

Source: B1-B11  
Sample No.: B6-11  
Elev. or Depth: 11  
Location:  
Description: clayey SAND  
Date: 9-25-03  
Liquid Limit:                      Plastic Limit:                      Natural Moisture:  
Testing Remarks:                      USCS Class.: SC

Mechanical Analysis Data

	Initial	After wash
Dry sample and tare=	910.90	692.50
Tare =	216.90	216.90
Dry sample weight =	694.00	475.60
Minus #200 from wash=	31.5 %	
Tare for cumulative weight retained=	.00	

Sieve	Cumul. Wt. retained	Percent finer
# 4	0.00	100.0
# 8	0.00	100.0
# 16	1.90	99.7
# 30	17.30	97.5
# 50	138.10	80.1
# 100	387.20	44.2
# 200	473.70	31.7

Fractional Components

Gravel/Sand based on #4  
Sand/Fines based on #200  
% COBBLES =                      % GRAVEL =                      % SAND = 68.3  
% FINES = 31.7

D85= 0.34    D60= 0.21    D50= 0.17



# Particle Size Distribution Report

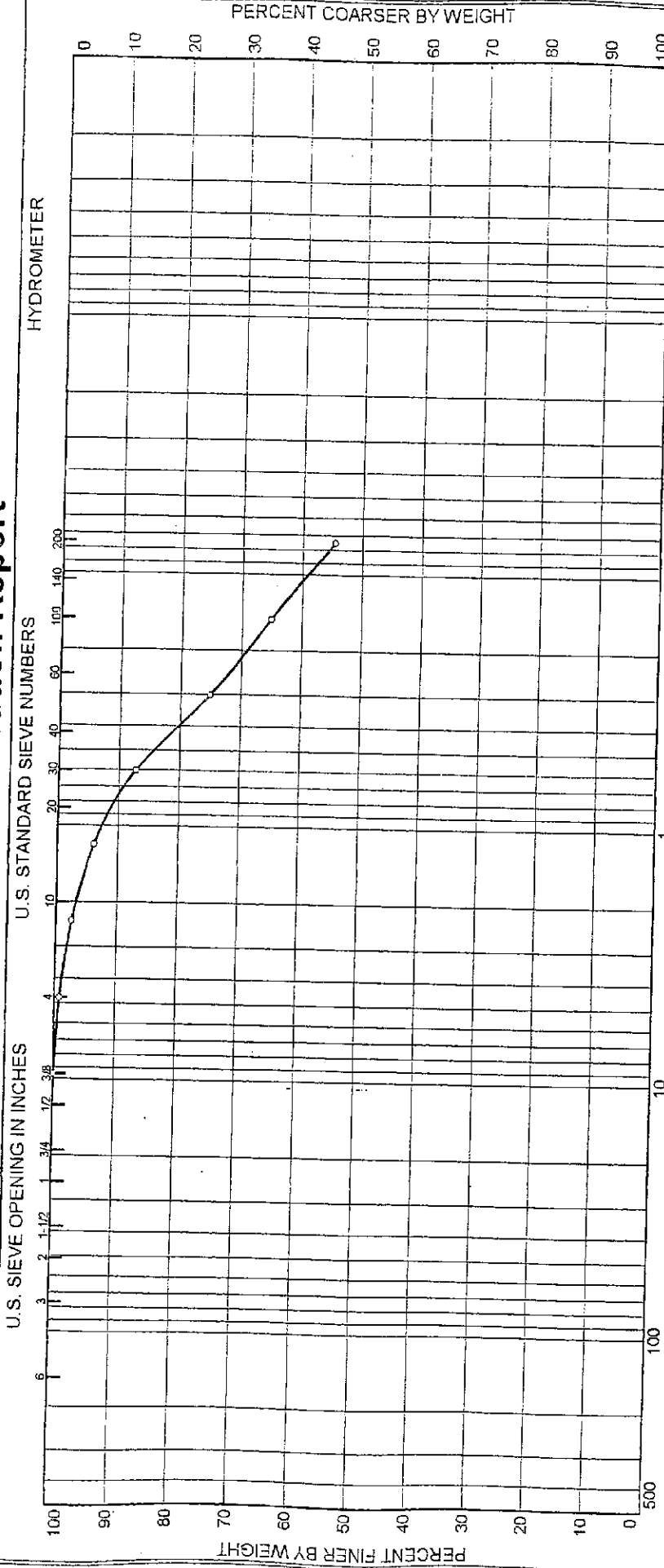

	% COBBLES	0.0	% GRAVEL	0.8	% SAND	44.6	% SILT	54.6	% CLAY	
SOURCE	B1-B11	DEPTH/ELEV.	24	DATE SAMPLED	9-25-03	USCS	CL	MATERIAL DESCRIPTION	Sandy lean CLAY	
								NM %	LL	PL

Client: \_\_\_\_\_

Project: Project "G"

Project No. S8689-06-02

**GEOCON CONSULTANTS, INC.**

Figure

---

---

GRAIN SIZE DISTRIBUTION TEST DATA

---

Client:  
Project: Project "G"  
Project Number: S8689-06-02

---

Sample Data

---

Source: B1-B11  
Sample No.: B7-24  
Elev. or Depth: 24  
Location: Sample Length (in./cm.):  
Description: Sandy lean CLAY  
Date: 9-25-03  
Liquid Limit: Natural Moisture:  
Plastic Limit: USCS Class.: CL  
Testing Remarks:

---

Mechanical Analysis Data

---

	Initial	After wash
Dry sample and tare=	604.30	389.10
Tare =	210.90	210.90
Dry sample weight =	393.40	178.20
Minus #200 from wash=	54.7 %	
Tare for cumulative weight retained=	.00	
Sieve	Cumul. Wt. retained	Percent finer
.375 inch	0.00	100.0
# 4	3.30	99.2
# 8	10.20	97.4
# 16	23.90	93.9
# 30	50.50	87.2
# 50	97.80	75.1
# 100	136.80	65.2
# 200	178.70	54.6

---

Fractional Components

---

Gravel/Sand based on #4  
Sand/Fines based on #200  
% COBBLES = % GRAVEL = 0.8 % SAND = 44.6  
% FINES = 54.6  
  
D<sub>85</sub> = 0.52    D<sub>60</sub> = 0.11

---

# Particle Size Distribution Report

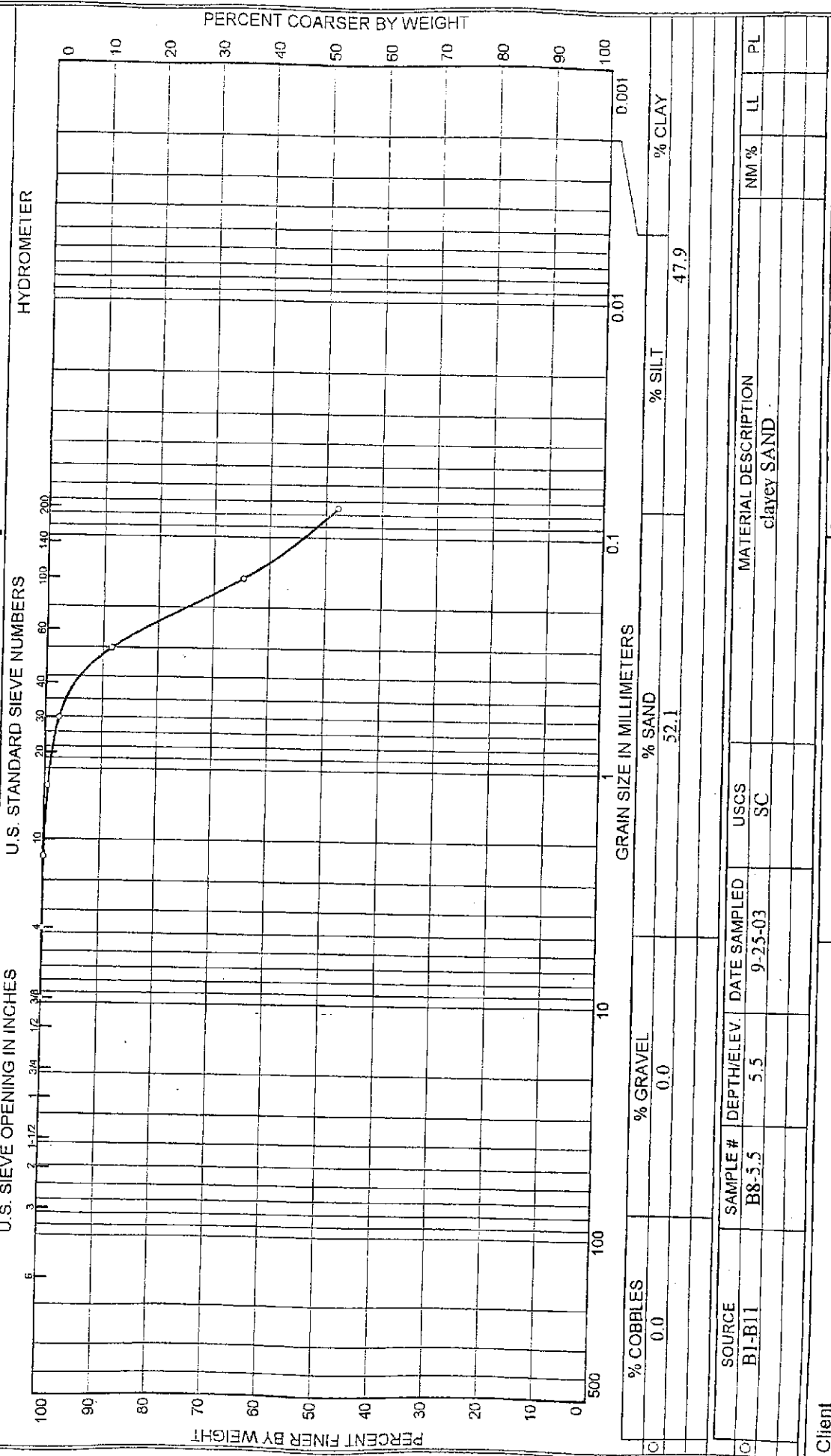

	% COBBLES	% GRAVEL	% SAND	% SILT	% CLAY
	0.0	0.0	52.1	47.9	
SOURCE	DEPTH/ELEV.	DATE SAMPLED	USCS	MATERIAL DESCRIPTION	NM %
BI-B11	5.5	9-25-03	SC	clayey SAND	LL
					PL
Client					
Project Project "G"					
GEOCON CONSULTANTS, INC.					
Project No. S8689-06-02				Figure	

---

---

GRAIN SIZE DISTRIBUTION TEST DATA

---

Client:  
Project: Project "G"  
Project Number: S8689-06-02

---

Sample Data

---

Source: B1-B11  
Sample No.: B8-5.5  
Elev. or Depth: 5.5  
Location:  
Description: clayey SAND  
Date: 9-25-03  
Liquid Limit:  
Testing Remarks:

Sample Length (in./cm.):  
  
Natural Moisture:  
Plastic Limit:                      USCS Class.: SC

---

Mechanical Analysis Data

---

	Initial	After wash
Dry sample and tare=	888.90	554.20
Tare =	186.00	186.00
Dry sample weight =	702.90	368.20
Minus #200 from wash=	47.6 %	
Tare for cumulative weight retained=	.00	

Sieve	Cumul. Wt. retained	Percent finer
.375 inch	0.00	100.0
# 4	0.20	100.0
# 8	1.00	99.9
# 16	4.60	99.4
# 30	17.40	97.5
# 50	81.90	88.4
# 100	248.90	64.6
# 200	366.30	47.9

---

Fractional Components

---

Gravel/Sand based on #4  
Sand/Fines based on #200  
% COBBLES =                      % GRAVEL =                      % SAND = 52.1  
% FINES = 47.9

D<sub>85</sub>= 0.27    D<sub>60</sub>= 0.13    D<sub>50</sub>= 0.08

---

# Particle Size Distribution Report

U.S. STANDARD SIEVE NUMBERS

U.S. SIEVE OPENING IN INCHES

HYDROMETER

PERCENT COARSER BY WEIGHT

PERCENT FINER BY WEIGHT

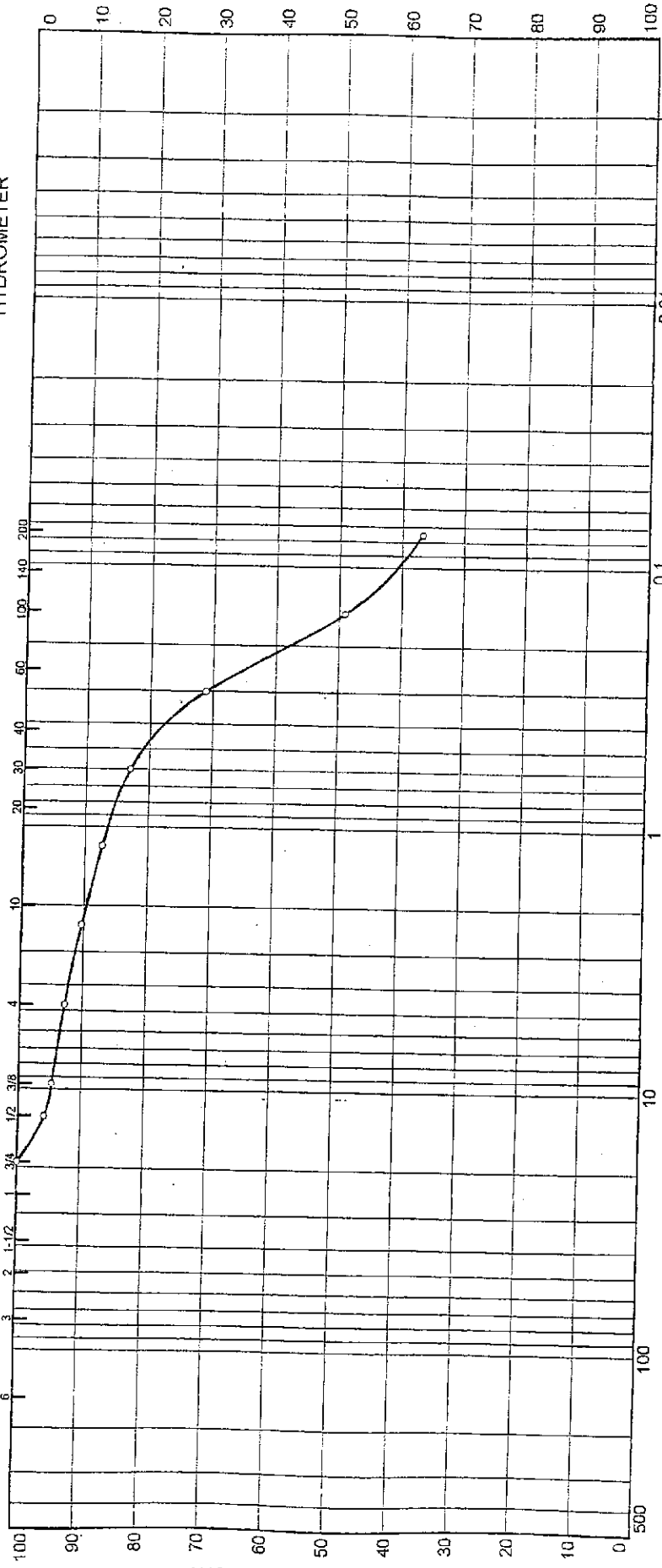

% COBBLES	0.0	% GRAVEL	7.2	% SAND	56.1	% SILT	36.7	% CLAY	0.001
-----------	-----	----------	-----	--------	------	--------	------	--------	-------

SOURCE	DEPTH/ELEV.	DATE SAMPLED	USCS	MATERIAL DESCRIPTION	NM %	LL	PL
BI-B11	10	9-25-03	SC	Clayey SAND			

Client \_\_\_\_\_

Project Project "G" \_\_\_\_\_

GEOCON CONSULTANTS, INC.

Project No. S8689-06-02 Figure

---

---

GRAIN SIZE DISTRIBUTION TEST DATA

---

Client:  
Project: Project "G"  
Project Number: S8689-06-02

---

Sample Data

---

Source: B1-B11  
Sample No.: B8-10  
Elev. or Depth: 10  
Location: Sample Length (in./cm.):  
Description: Clayey SAND  
Date: 9-25-03  
Liquid Limit: Plastic Limit: Natural Moisture:  
Testing Remarks: USCS Class.: SC

---

Mechanical Analysis Data

---

	Initial	After wash
Dry sample and tare=	433.40	347.70
Tare =	197.70	197.70
Dry sample weight =	235.70	150.00
Minus #200 from wash=	36.4 %	
Tare for cumulative weight retained=	.00	

Sieve	Cumul. Wt. retained	Percent finer
.75 inch	0.00	100.0
0.5 inch	10.00	95.8
.375 inch	12.60	94.7
# 4	17.10	92.8
# 8	22.80	90.3
# 16	30.20	87.2
# 30	40.10	83.0
# 50	68.10	71.1
# 100	120.20	49.0
# 200	149.30	36.7

---

Fractional Components

---

Gravel/Sand based on #4  
Sand/Fines based on #200  
‡ COBBLES =                   % GRAVEL = 7.2                   % SAND = 56.1  
‡ FINES = 36.7  
D85= 0.77   D60= 0.21   D50= 0.16



## EXPANSION INDEX TEST

Project No: S8689-06-02      JOB Project "G"      ASTM D4829-88

Sample #2      DATE 9/17/2003      BY PO

Initial Ht = 1 inches       $G_s = 2.7$       Factor =  $\frac{(4)(1728)(2.2046)}{(\pi)(4.01)^2(1000)} = 0.3016$

$$E_{raw} = \frac{(1000)(\Delta H)}{H}$$

$$Dry\ Density\ (pcf) = \gamma_d = \frac{(Calc'd\ Dry\ Wt,\ gms)\ (Factor)}{(Sample\ ht.\ in\ inches)}$$

$$E_{corrected} = E_{raw} - \frac{(50-S)(65 + E_{raw})}{220-S}$$

$$Saturation = \frac{(100)(w)(G_s)(v_d)}{[(G_s)(62.4)] - v_d}$$

where: w = % moisture in decimal  
 S = saturation in percent  
 H = initial height  
 ΔH = total change in height

0 - 20 VERY LOW  
 21 - 50 LOW  
 51 - 90 MEDIUM  
 91 - 130 HIGH  
 > 130 VERY HIGH

TRIAL 1						TRIAL 2					
DATE	TIME	LOAD	DIAL READ	REV COUNT	TOTAL EXPAN	DATE	TIME	LOAD	DIAL READ	REV COUNT	TOTAL EXPAN
DRY						DRY					
		1 psi			0.0000	15-Sep	11:10a	1 psi	0.0202		0.0000
		1 psi			0.0000		11:20a	1 psi	0.0199		-0.0003
WET						WET					
		1 psi			0.0000		11:57a	1 psi	0.0412		0.0210
		1 psi			0.0000		1:25p	1 psi	0.0511		0.0309
		1 psi			0.0000		5:10p	1 psi	0.0544		0.0342
		1 psi			0.0000	16-Sep	6:55a	1 psi	0.0572		0.0370
		1 psi			0.0000		10:09a	1 psi	0.0575		0.0373
		1 psi			0.0000		11:10a	1 psi	0.0577		0.0375
		1 psi			0.0000						

TRIAL 1						TRIAL 2					
Moisture Content			Density			Moisture Content			Density		
	Before	After		Before	After		Before	After		Before	After
Tare No.	Z-6					Tare No.		64			
Gross Wet Wt (gm)	431.9		Wet + ring (gms)	558.9		Gross Wet Wt (gm)	1617.6	606	Wet + ring (gms)	577.6	609.3
Gross Dry Wt (gm)	395.7		Ring (gms)	199.8		Gross Dry Wt (gm)	1431.5	530.8	Ring (gms)	199	199
Water Loss (gm)	36.2		Wet Soil (gms)	359.1		Water Loss (gm)	186.1	75.2	Wet Soil (gms)	378.6	410.3
Tare Wt. (gm)	68.7		Calc'd dry soil (gms)	323.3	323.3	Tare Wt. (gm)	0	198.5	Calc'd dry soil (gms)	335.0	335.0
Net Dry Wt (gm)	327		Dry Dens (pcf)	97.5		Net Dry Wt (gm)	1431.5	332.3	Dry Dens (pcf)	101.0	97.4
% Moisture	11.1					% Moisture	13.0	22.6			

Calculated Saturation (%)	41.1		Calculated Saturation (%)	52.6	83.7
Total Swell (%)			Total Swell (%)		3.8
Expansion Index (raw)			Expansion Index (raw)		38
Expansion Index (corrected)			Expansion Index (corrected)		39

Adjusted Water content to 13.0%







## EXPANSION INDEX TEST

Project No: S8689-06-02      JOB Project "G"      ASTM D4829-88

Sample #6      DATE 9/15/2003      BY PO

Initial Ht = 1 inches       $G_s = 2.7$       Factor =  $\frac{(4)(1728)(2.2046)}{(\pi)(4.01)^2(1000)} = 0.3016$

$E_{I_{raw}} = \frac{(1000)(\Delta H)}{H}$       Dry Density (pcf) =  $\gamma_d = \frac{(\text{Calc'd Dry Wt, gms})(\text{Factor})}{(\text{Sample ht. in inches})}$

$E_{I_{corrected}} = E_{I_{raw}} - \frac{(50-S)(65 + E_{I_{raw}})}{220-S}$       where: w = % moisture in decimal      0 - 20 VERY LOW  
 S = saturation in percent      21 - 50 LOW  
 H = initial height      51 - 90 MEDIUM  
 $\Delta H$  = total change in height      91 - 130 HIGH  
 > 130 VERY HIGH

Saturation =  $\frac{(100)(w)(G_s)(\gamma_d)}{[(G_s)(62.4)] - \gamma_d}$

TRIAL 1						TRIAL 2					
DATE	TIME	LOAD	DIAL READ	REV COUNT	TOTAL EXPAN	DATE	TIME	LOAD	DIAL READ	REV COUNT	TOTAL EXPAN
DRY						DRY					
16-Sep	10:26a	1 psi	0.0824		0.0000			1 psi			
	10:36a	1 psi	0.0821		-0.0003			1 psi			
WET						WET					
	11:22a	1 psi	0.1048		0.0224			1 psi			
	12:31p	1 psi	0.1169		0.0345			1 psi			
	1:27p	1 psi	0.1238		0.0414			1 psi			
	4:28p	1 psi	0.1393		0.0569			1 psi			
	7:24a	1 psi	0.1633		0.0809			1 psi			
	9:31a	1 psi	0.164		0.0816			1 psi			
	12:08p	1 psi	0.1647		0.0823			1 psi			
	1:57p	1 psi	0.1652		0.0828						

TRIAL 1					TRIAL 2				
Moisture Content			Density		Moisture Content			Density	
	Before	After		Before	After		Before	After	
Tare No.	2-4	62				Tare No.			
Gross Wet Wt (gm)	435.8	604.6	Wet + ring (gms)	734	775.3	Gross Wet Wt (gm)			
Gross Dry Wt (gm)	386.3	515.7	Ring (gms)	366.4	366.4	Gross Dry Wt (gm)			
Water Loss (gm)	49.5	88.9	Wet Soil (gms)	367.6	409.4	Water Loss (gm)			
Tare Wt. (gm)	69.6	198.4	Calc'd dry soil (gms)	317.9	317.9	Tare Wt. (gm)			
Net Dry Wt (gm)	316.7	317.3	Dry Dens (pcf)	95.9	88.5	Net Dry Wt (gm)			
% Moisture	15.6	28.0				% Moisture			

Calculated Saturation (%)	55.7	83.8	Calculated Saturation (%)	
Total Swell (%)		8.3	Total Swell (%)	
Expansion Index (raw)		83	Expansion Index (raw)	
Expansion Index (corrected)		88	Expansion Index (corrected)	



## EXPANSION INDEX TEST

Project No: S8689-06-02      JOB Project "G"      ASTM D4829-88

Sample B9-1-2      DATE 9/18/2003      BY PO

Initial Ht = 1 inches       $G_s = 2.7$       Factor =  $\frac{(4)(1728)(2.2046)}{(\pi)(4.01)^2(1000)} = 0.3016$

$EI_{raw} = \frac{(1000)(\Delta H)}{H}$       Dry Density (pcf) =  $\gamma_d = \frac{(\text{Calc'd Dry Wt, gms})(\text{Factor})}{(\text{Sample ht. in inches})}$

$EI_{corrected} = EI_{raw} - \frac{(50-S)(65 + EI_{raw})}{220-S}$       where: w = % moisture in decimal      0 - 20 VERY LOW  
 S = saturation in percent      21 - 50 LOW  
 H = initial height      51 - 90 MEDIUM  
 $\Delta H$  = total change in height      91 - 130 HIGH  
 > 130 VERY HIGH

Saturation =  $\frac{(100)(w)(G_s)(\gamma_d)}{[(G_s)(62.4)] - \gamma_d}$

### TRIAL 1

### TRIAL 2

DATE	TIME	LOAD	DIAL READ	REV COUNT	TOTAL EXPAN	DATE	TIME	LOAD	DIAL READ	REV COUNT	TOTAL EXPAN
DRY						DRY					
19-Sep	11:18a	1 psi	0.0523		0.0000			1 psi			
	11:28a	1 psi	0.0515		-0.0008			1 psi			
WET						WET					
	12:06p	1 psi	0.1476		0.0953			1 psi			
	2:35p	1 psi	0.1815		0.1292			1 psi			
	5:24p	1 psi	0.1858		0.1335			1 psi			
	7:39a	1 psi	0.1923		0.1400			1 psi			
		1 psi						1 psi			
		1 psi						1 psi			
		1 psi						1 psi			
		1 psi						1 psi			

### TRIAL 1

### TRIAL 2

Moisture Content			Density			Moisture Content			Density		
	Before	After		Before	After		Before	After		Before	After
Tare No.	Z-7	CB				Tare No.					
Gross Wet Wt (gm)	400.3	625.2	Wet + ring (gms)	539.3	606.9	Gross Wet Wt (gm)			Wet + ring (gms)		
Gross Dry Wt (gm)	353.6	509	Ring (gms)	198.9	366.4	Gross Dry Wt (gm)			Ring (gms)		
Water Loss (gm)	46.7	116.2	Wet Soil (gms)	340.4	240.5	Water Loss (gm)			Wet Soil (gms)		
Tare Wt. (gm)	69.8	219.7	Calc'd dry soil (gms)	292.3	292.3	Tare Wt. (gm)			Calc'd dry soil (gms)		
Net Dry Wt (gm)	283.8	289.3	Dry Dens (pcf)	88.2	77.3	Net Dry Wt (gm)			Dry Dens (pcf)		
% Moisture	16.5	40.2				% Moisture					
Calculated Saturation (%)			48.8	92.0		Calculated Saturation (%)					
Total Swell (%)				14.1		Total Swell (%)					
Expansion Index (raw)				141		Expansion Index (raw)					
Expansion Index (corrected)				139		Expansion Index (corrected)					

# EXPANSION INDEX TEST

Project No: S8689-06-02      JOB Project "G"      ASTM D4829-88

Sample B10-0.5      DATE 9/18/2003      BY PO

Initial Ht = 1 inches       $G_s = 2.7$       Factor =  $\frac{4(1728)(2.2046)}{(\pi)(4.01)^2(1000)} = 0.3016$

$EI_{raw} = \frac{(1000)(\Delta H)}{H}$       Dry Density (pcf) =  $\gamma_d = \frac{(\text{Calc'd Dry Wt, gms}) (\text{Factor})}{(\text{Sample ht. in inches})}$

$EI_{corrected} = EI_{raw} - \frac{(50-S)(65+EI_{raw})}{220-S}$       where: w = % moisture in decimal      0 - 20 VERY LOW  
 S = saturation in percent      21 - 50 LOW  
 H = initial height      51 - 90 MEDIUM  
 $\Delta H$  = total change in height      91 - 130 HIGH  
 > 130 VERY HIGH

Saturation =  $\frac{(100)(w)(G_s)(\gamma_d)}{[(G_s)(62.4)] - \gamma_d}$

TRIAL 1						TRIAL 2					
DATE	TIME	LOAD	DIAL READ	REV COUNT	TOTAL EXPAN	DATE	TIME	LOAD	DIAL READ	REV COUNT	TOTAL EXPAN
DRY						DRY					
19-Sep	9:59a	1 psi	0.035		0.0000			1 psi			
	10:09a	1 psi	0.0347		-0.0003			1 psi			
WET						WET					
	10:24a	1 psi	0.0551		0.0201			1 psi			
	12:05p	1 psi	0.0816		0.0466			1 psi			
	2:34p	1 psi	0.0973		0.0623			1 psi			
	5:25p	1 psi	0.1099		0.0749			1 psi			
22-Sep	7:38a	1 psi	0.1223		0.0873			1 psi			
		1 psi						1 psi			
		1 psi						1 psi			
		1 psi						1 psi			

TRIAL 1					TRIAL 2				
Moisture Content			Density		Moisture Content			Density	
	Before	After		Before	After		Before	After	
Tare No.	z-1	CB				Tare No.			
Gross Wet Wt (gm)	429.3	631.9	Wet + ring (gms)	747	796	Gross Wet Wt (gm)			
Gross Dry Wt (gm)	388.1	539.2	Ring (gms)	366.5	366.5	Gross Dry Wt (gm)			
Water Loss (gm)	41.2	92.7	Wet Soil (gms)	380.5	429.5	Water Loss (gm)			
Tare Wt. (gm)	70.5	206.4	Calc'd dry soil (gms)	336.8	336.8	Tare Wt. (gm)			
Net Dry Wt (gm)	317.6	332.8	Dry Dens (pcf)	101.6	93.4	Net Dry Wt (gm)			
% Moisture	13.0	27.9				% Moisture			
Calculated Saturation (%)			53.2	93.6	Calculated Saturation (%)				
Total Swell (%)			8.8		Total Swell (%)				
Expansion Index (raw)			88		Expansion Index (raw)				
Expansion Index (corrected)			91		Expansion Index (corrected)				

UNCONFINED COMPRESSION TEST

Project Name: Project "G"

Project Number: S8689-06-02



3160 Gold Valley Drive Suite 800  
Rancho Cordova, CA 95742  
Tel: 916.852.9118 Fax: 916.852.9118

SAMPLE ID	USCS	CL
B2-2.5	Light olive brown lean CLAY	
INITIAL HEIGHT (in)	5	
INITIAL DIAMETER (in)	2.41	
INITIAL AREA (in <sup>2</sup> )	4.562	2.36
VOLUME (in <sup>3</sup> )	22.808	1.18
MOISTURE CONTENT (%)	25.8	
DRY DENSITY (pcf)	97.1	

Vertical Dial (0.001 inch)	Load Dial (Lbs)	ΔL (inch)	Strain	Strain (%)	Corrected Area (in <sup>2</sup> )	c=P/A (psf)
0	0	0	0.000	0.00	4.562	0
10	12	0.01	0.002	0.20	4.571	378
20	28	0.02	0.004	0.40	4.580	880
40	64.9	0.04	0.008	0.80	4.598	2032
50	78.7	0.05	0.010	1.00	4.608	2460
60	95.5	0.06	0.012	1.20	4.617	2979
70	106.8	0.07	0.014	1.40	4.626	3324
80	116.5	0.08	0.016	1.60	4.636	3619
90	124	0.09	0.018	1.80	4.645	3844
100	129.7	0.1	0.020	2.00	4.655	4012
120	138.3	0.12	0.024	2.40	4.674	4261
140	144.2	0.14	0.028	2.80	4.693	4425
160	147.4	0.16	0.032	3.20	4.712	4504
180	148.8	0.18	0.036	3.60	4.732	4528
200	149.3	0.2	0.040	4.00	4.752	4524
220	150.9	0.22	0.044	4.40	4.772	4554
240	154.2	0.24	0.048	4.80	4.792	4634
260	157.1	0.26	0.052	5.20	4.812	4701
280	158.2	0.28	0.056	5.60	4.832	4714
300	157.5	0.3	0.060	6.00	4.853	4674
330	141.7	0.35	0.070	7.00	4.905	4160
400	100.6	0.4	0.080	8.00	4.958	2922

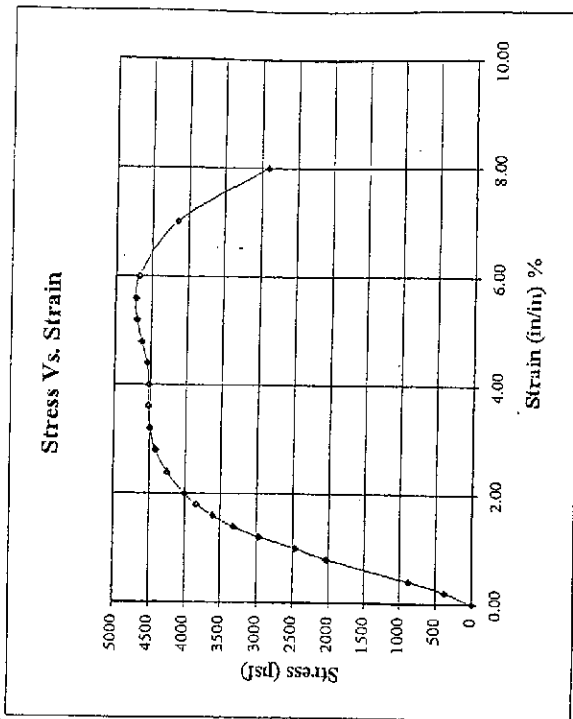

Note: Sample failed in caliche lens about middle of sample

# UNCONFINED COMPRESSION TEST

Project Name: Project "G"

Project Number: S8689-06-02

SAMPLE ID:	B3-3
INITIAL HEIGHT (in.)	5
INITIAL DIAMETER (in.)	2.41
INITIAL AREA (in <sup>2</sup> )	4.562
VOLUME (in <sup>3</sup> )	22.808
MOISTURE CONTENT (%)	25.8
DRY DENSITY (pcf)	97.3

USCS	CL
DESCRIPTION	Light olive brown lean CLAY
Maximum $\sigma_c$ (psf)	1621
$\sigma_c$ @ failure (psf)	810
$\epsilon_c$ @ failure (%)	8.0%

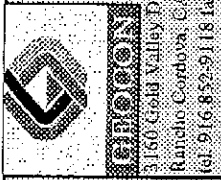

Vertical Dial (0.001 inch)	Load Dial (Lbs.)	$\Delta L$ (inch)	Strain (%)	Corrected Area (in <sup>2</sup> )	$\sigma = P/A$ (psf)
0	0	0	0.000	4.562	0
10	7.2	0.01	0.002	4.571	227
20	16.6	0.02	0.004	4.580	522
30	30.4	0.03	0.006	4.589	954
50	49.7	0.05	0.010	4.608	1553
60	58.1	0.06	0.012	4.617	1812
80	68.4	0.08	0.016	4.636	2125
90	71.8	0.09	0.018	4.645	2226
100	74.6	0.1	0.020	4.655	2308
120	79.2	0.12	0.024	4.674	2440
140	83.4	0.14	0.028	4.693	2559
160	86.6	0.16	0.032	4.712	2646
180	89.4	0.18	0.036	4.732	2721
200	92	0.2	0.040	4.752	2788
225	95	0.225	0.045	4.777	2864
250	98	0.25	0.050	4.802	2939
275	100.8	0.275	0.055	4.827	3007
300	103.3	0.3	0.060	4.853	3065
325	105.9	0.325	0.065	4.879	3126
350	108.2	0.35	0.070	4.905	3176
375	110.1	0.375	0.075	4.932	3215
400	111.6	0.4	0.080	4.958	3241
450	112.8	0.45	0.090	5.013	3240
500	112.3	0.5	0.100	5.069	3191
550	109	0.55	0.110	5.125	3062
600	90.6	0.6	0.120	5.184	2517

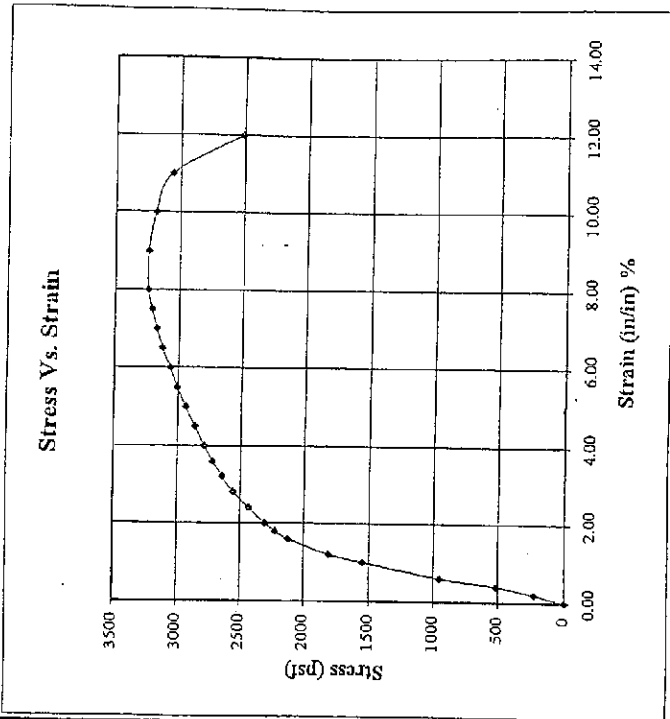

Localized failure near bottom of sample



# CONSOLIDATION TEST

Project Name: Project "G"  
 Project Number: S8689-06-02      Sample Number: B7-36

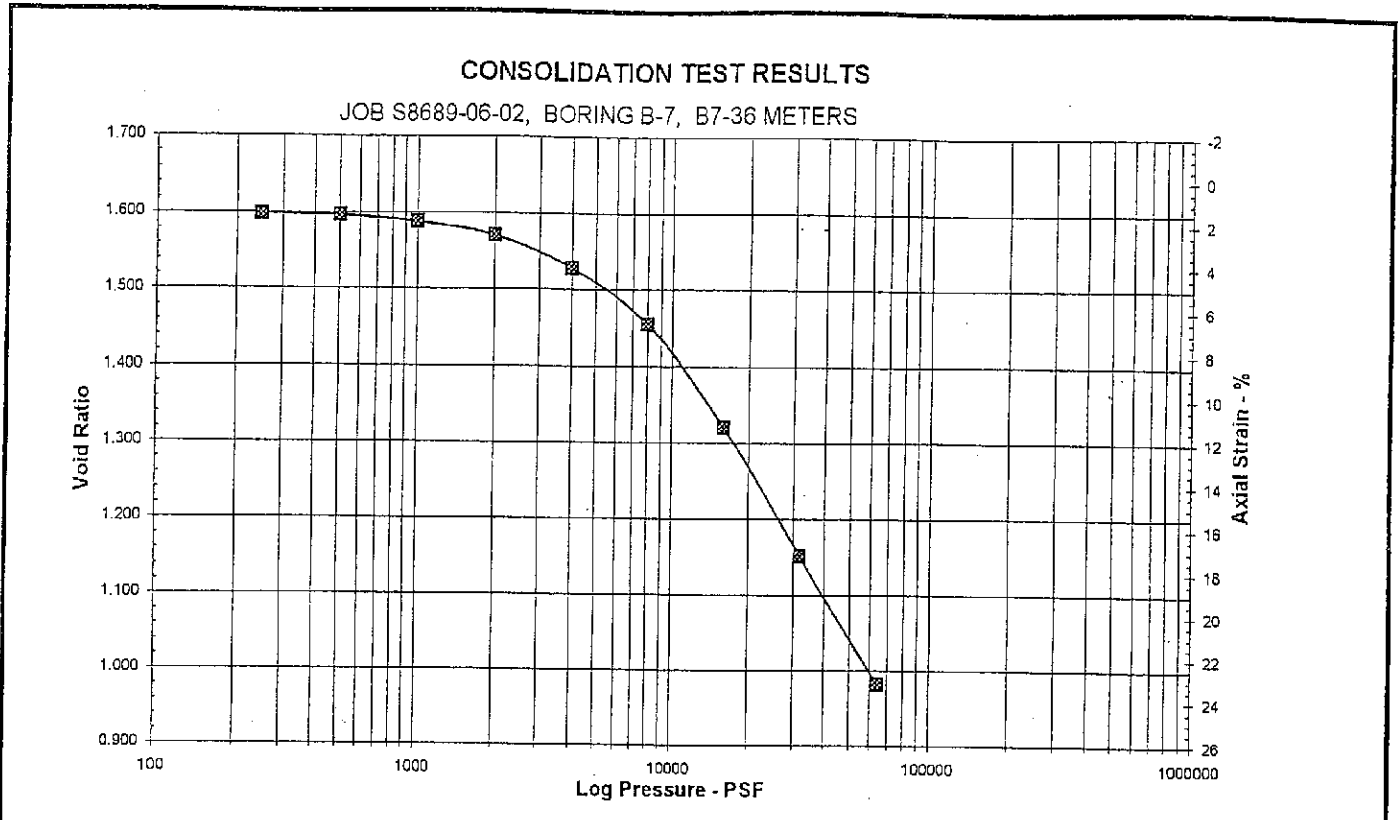

Axial Load (psf)	Void Ratio	Axial Strain (%)	$m_v$ , coef of vol Compres (in <sup>2</sup> /lb)	$C_c$ , Comp Index	50% Consolidation		90% Consolidation	
					$t_{50}$ , Time to Consol (min)	$C_v$ , Coeff of Consol (ft <sup>2</sup> /yr)	$t_{90}$ , Time to Consol (min)	$C_v$ , Coeff of Consol (ft <sup>2</sup> /yr)
0	1.5864	0.00						
250	1.5978	-0.44						
500	1.5964	-0.39	0.0000	0.000	0.00	0.00	0.00	0.00
1000	1.5885	-0.08	0.0009	0.026	2.33	43.54	4.83	90.64
2000	1.5702	0.63	0.0010	0.061	2.19	45.87	4.54	95.49
4000	1.5274	2.28	0.0012	0.142	1.99	49.32	4.12	102.68
8000	1.4540	5.12	0.0010	0.244	2.78	33.70	5.76	70.16
16000	1.3202	10.29	0.0010	0.444	4.82	17.88	9.97	37.22
32000	1.1519	16.80	0.0007	0.559	8.92	8.47	18.47	17.63
64000	0.9812	23.40	0.0004	0.567	10.34	6.24	21.41	12.99

$G_s = 2.9$ (assumed)	COND AT START OF TEST	COND AT END OF TEST	 3160 Gold Valley Drive, Suite 800 Rancho Cordova, CA 95742 tel: 916-852-9118 fax: 916-852-9132
HEIGHT (in.)	0.7500	0.6401	
MOISTURE CONTENT (%)	49.4	41.5	
DRY DENSITY (pcf):	70.0	82.0	
SATURATION (%)	90.4	99.8	
VOID RATIO	1.586	0.981	

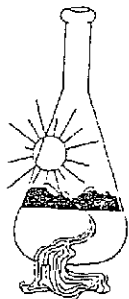

# Sunland Analytical

11353 Pyrites Way, Suite 4  
Rancho Cordova, CA 95670  
(916) 852-8557

Date Reported 09/17/2003  
Date Submitted 09/11/2003

To: Jeremy Zorne  
Geocon  
3160 Gold Valley Dr. #800  
Rancho Cordova, CA 95742

From: Gene Oliphant, Ph.D. \ Randy Horney  
General Manager \ Lab Manager

The reported analysis was requested for the following location:  
Location : AG PROPERTY Site ID : 2.  
Thank you for your business.

\* For future reference to this analysis please use SUN # 40270-78027.

---

## EVALUATION FOR SOIL CORROSION

Soil pH	6.29		
Minimum Resistivity	1.05	ohm-cm (x1000)	
Chloride	43.6 ppm	00.00436	%
Sulfate	15.6 ppm	00.00156	%

### METHODS

pH and Min. Resistivity CA DOT Test #643 Mod. (Sm. Cell)  
Sulfate CA DOT Test #417, Chloride CA DOT Test #422

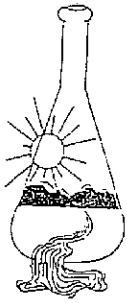

# Sunland Analytical

11353 Pyrites Way, Suite 4  
Rancho Cordova, CA 95670  
(916) 852-8557

Date Reported 09/17/2003  
Date Submitted 09/11/2003

To: Jeremy Zorne  
Geocon  
3160 Gold Valley Dr. #800  
Rancho Cordova, CA 95742

From: Gene Oliphant, Ph.D. \ Randy Horney  
General Manager \ Lab Manager *RO*

The reported analysis was requested for the following location:  
Location : AG PROPERTY Site ID : 4.  
Thank you for your business.

\* For future reference to this analysis please use SUN # 40270-78028.

---

## EVALUATION FOR SOIL CORROSION

Soil pH	5.94		
Minimum Resistivity	0.86	ohm-cm (x1000)	
Chloride	57.4 ppm	00.00574	%
Sulfate	24.2 ppm	00.00242	%

### METHODS

pH and Min. Resistivity CA DOT Test #643 Mod. (Sm. Cell)  
Sulfate CA DOT Test #417, Chloride CA DOT Test #422

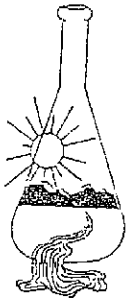

# Sunland Analytical

11353 Pyrites Way, Suite 4  
Rancho Cordova, CA 95670  
(916) 852-8557

Date Reported 09/17/2003  
Date Submitted 09/11/2003

To: Jeremy Zorne  
Geocon  
3160 Gold Valley Dr. #800  
Rancho Cordova, CA 95742

From: Gene Oliphant, Ph.D. \ Randy Horney  
General Manager \ Lab Manager *RD*

The reported analysis was requested for the following location:  
Location : AG PROPERTY Site ID : 6.  
Thank you for your business.

\* For future reference to this analysis please use SUN # 40270-78029.

---

## EVALUATION FOR SOIL CORROSION

Soil pH	5.90		
Minimum Resistivity	1.02	ohm-cm (x1000)	
Chloride	60.7 ppm	00.00607	%
Sulfate	20.0 ppm	00.00200	%

### METHODS

pH and Min. Resistivity CA DOT Test #643 Mod. (Sm. Cell)  
Sulfate CA DOT Test #417, Chloride CA DOT Test #422

*Lakeville Site – Geologic and Geotechnical Feasibility  
Report*

**D  
R  
A  
F  
T**

**DRAFT GEOLOGIC AND  
GEOTECHNICAL FEASIBILITY  
REPORT**

**PROJECT "G" - PROPOSED SONOMA  
CASINO  
SONOMA COUNTY, CALIFORNIA**

**PREPARED FOR  
STATION CASINOS  
ROCKLIN, CALIFORNIA**

**JUNE 2003**

# DRAFT

Project No. S8689-06-01  
June , 2003

Mr. Joe Imbriani  
Station Casinos, Inc.  
1151 West Sunset Boulevard  
Rocklin, California 95765

Subject: PROJECT "G" - PROPOSED SONOMA CASINO  
"MIDDLE SECTION" - APNs 068-140-018 AND 068-160-006  
SONOMA COUNTY, CALIFORNIA  
DRAFT GEOLOGIC AND GEOTECHNICAL FEASIBILITY INVESTIGATION

Dear Mr. Imbriani:

In accordance with your request, Geocon has performed a geologic and geotechnical feasibility investigation of the subject project. The study was conducted to determine the site soil and geologic conditions, and to identify potential geologic hazards that may impact the property with respect to future development. This information will be used to aid in determining a "technically preferred" location within the site to develop the subject project.

The accompanying report presents the findings of our preliminary study with respect to the geotechnical aspects of site development. In general, no soil or geologic conditions were encountered that would preclude development of the property as planned.

Should you have questions regarding this report, or if we may be of further service, please contact the undersigned at your convenience.

Sincerely,

**GEOCON CONSULTANTS, INC.**

DRAFT

Jeremy J. Zorne, PE  
Project Engineer

DRAFT

John D. Matthey, CEG  
Project Geologist

DRAFT

Daniel J. Koelzer, GE  
Senior Engineer

JJZ:JDM:DJK:krc

(10) Addressee

## TABLE OF CONTENTS

1.0	PURPOSE AND SCOPE.....	1
2.0	SITE AND PROJECT DESCRIPTION .....	3
2.1	Site Description .....	3
2.2	Project Description .....	4
3.0	SOIL AND GEOLOGIC CONDITIONS .....	5
3.1	Artificial Fill (af, afbm).....	5
3.2	Alluvium (Qal, Qhf, Qpf).....	5
3.3	Bay Mud (Qhbm).....	6
3.3.1	Younger Bay Mud.....	6
3.3.2	Alluvial Interface Sand Deposit.....	6
3.3.3	Older Bay Mud.....	6
3.4	Upper Petaluma Formation (Tpu).....	7
3.5	Groundwater .....	7
4.0	GEOLOGIC HAZARDS .....	8
4.1	Seismic Impacts.....	8
4.1.1	Ground Shaking .....	8
4.1.2	Liquefaction .....	10
4.1.3	Lateral Spreading .....	10
4.1.4	Seismically Induced Flooding.....	10
4.2	Slope Stability, Landslides .....	10
4.3	Mudwaves.....	10
4.4	Expansive Soil.....	11
4.5	Corrosive Soil.....	11
4.6	Settlement.....	11
4.7	Subsidence.....	11
5.0	CONCLUSIONS AND RECOMMENDATIONS .....	13
5.1	General .....	13
5.2	Grading – Earthwork .....	14
5.2.1	Lowland Area.....	14
5.2.2	Upland Area .....	15
5.3	Foundations .....	16
5.3.1	Lowland Area.....	16
5.3.2	Upland Area .....	17
5.4	Structures.....	17
5.5	Underground Utility Construction.....	18
5.5.1	Lowland Area.....	18
5.5.2	Upland Area .....	19
5.6	Pavement - Roadways .....	19
5.6.1	Lowland Area.....	19
5.6.2	Upland Area .....	20
5.7	Future Project Plans.....	21
6.0	LIMITATIONS AND UNIFORMITY OF CONDITIONS .....	22
7.0	LIST OF REFERENCES.....	23



TABLE OF CONTENTS (continued)

FIGURES

- Figure 1, Vicinity Map
- Figure 2, Site Plan/Geologic Map
- Figure 3, Cross-Section A-A'
- Figure 4, Cross-Section B-B'
- Figure 5, Cross-Section C-C'

APPENDIX A

FIELD INVESTIGATION

- Logs of Exploratory Trenches – Figures A1 through A13
- Logs of Exploratory Borings – Figures A14 through A26
- Logs of CPT soundings

APPENDIX B

LABORATORY TESTING PROGRAM

- Logs of Exploratory Trenches – Figures A1 through A13

# DRAFT GEOLOGIC AND GEOTECHNICAL FEASIBILITY INVESTIGATION

## 1.0 PURPOSE AND SCOPE

The purpose of this geologic and geotechnical constraints investigation was to identify the soil and geologic conditions at the site, determine the presence of geologic hazards (if any) and to provide preliminary geotechnical recommendations with respect to development of the proposed casino complex at the project site (see Vicinity Map, Figure 1). This information will be used to aid in determining a "technically preferred" development location within the project site. Additional design-level studies, including additional subsurface exploration, laboratory testing and geotechnical engineering analysis will be required prior to development of the site improvement plans.

The scope of our study consisted of a review of published geologic literature and other documentation provided by the project team (see *List of References*, Section 7 of this report), performing a site reconnaissance, and performing exploratory subsurface explorations at the site. Specifically, our study included the following:

- Reviewed area geologic maps and other literature pertaining to the site and vicinity.
- Reviewed stereoscopic aerial photographs of the site.
- Performed field mapping by an engineering geologist to identify the soil and geologic units and to determine the approximate areal extent of the units.
- Notified the local subscribing utility companies via Underground Service Alert (USA), as required by law, to determine the location of underground utilities in the vicinity of proposed exploratory excavation locations.
- Submitted requisite fees and obtained geotechnical boring permits from the Sonoma County Permit and Resource Management Department (PRMD).
- Excavated 13 exploratory test pits (TP1 through TP13) within the eastern portion of the site. The test pits were excavated to approximate depths ranging from five to ten feet below the existing ground surface (bgs). The approximate test pit locations are depicted on the Site Plan/Geologic Map, Figure 2. The exploratory test pits were logged by a California Certified Engineering Geologist. Logs of the exploratory trenches are included in Appendix A, Figures A1 through A13.
- Advanced six exploratory borings (B1 through B5 and P1) at the site with an all-terrain track carrier-mounted drill rig equipped with hollow-stem augers. The borings were advanced to approximate depths ranging from 30 to 70 feet bgs. Boring P1 was completed as a temporary piezometer to monitor groundwater conditions within the upper aquifer at the site. The approximate exploratory boring locations are depicted on the Site Plan/Geologic Map, Figure 2. The exploratory borings were logged by a California Certified Engineering Geologist. Logs of the exploratory borings are included in Appendix A, Figures A14 through A26.
- Advanced five cone penetration test (CPT) soundings (CPT1 through CPT5) at the site with a 20-ton CPT rig. The CPT soundings were advanced to approximate depths ranging from

98 to 143 feet bgs. The approximate CPT sounding locations are depicted on the Site Plan/Geologic Map, Figure 2. Electronic logs of the CPT soundings are included in Appendix A.

- Obtained relatively undisturbed and bulk soil samples from the test pits and exploratory borings.
- Performed geotechnical laboratory tests on selected soil samples to determine soil index and engineering properties including in situ density and moisture content, plasticity characteristics, consolidation potential, and shear strength parameters. Laboratory test procedures and results are included in Appendix B.
- Prepared this report summarizing our findings, conclusions and recommendations regarding the geotechnical and geologic conditions present at the site and the associated impacts to development.

## 2.0 SITE AND PROJECT DESCRIPTION

### 2.1 Site Description

The proposed project area consists of several parcels totaling approximately 2,100 acres near the intersection of Lakeville Road and State Route 37 (SR) 37 in southern Sonoma County, California (see Vicinity Map, Figure 1). Specifically, the following project site areas have been identified:

- **West Section** – 321 acres of undeveloped, agricultural land identified as Sonoma County Assessor's Parcel No. (APN) 068-150-010 located north of SR 37 and west of Lakeville Road.
- **North Section** – 922 acres of undeveloped agricultural land comprised of several APNs located north of SR 37 and east of Lakeville Road.
- **Middle Section** – 392 acres of primarily undeveloped agricultural land comprised of APNs 068-140-018 and 068-160-006 located south of SR 37 and east of Reclamation Road (southern extension of Lakeville Road).
- **South Section** – 447 acres of undeveloped agricultural land comprised of APNs 068-140-007 and 068-140-008 located south of Reclamation Road.

Presently, the "Middle Section" portion of the project site has been chosen for development of the proposed casino complex. As previously stated, the Middle Section is comprised of two adjacent APNs that form an approximately rectangular site totaling approximately 392 acres; however, a central parcel of approximately 92 acres is excluded from the project. This configuration results in a site that resembles a pair of eyeglasses. The site is bordered by SR 37 on the north, Reclamation Road on the west, the inactive Northwestern Pacific Railroad Line (NWPRR) on the south and a vineyard property on the east. The site configuration is depicted on the Site Plan/Geologic Map, Figure 2 (Map Pocket).

The site is primarily undeveloped with the exception of a barn structure within the southwest corner of the site and a former dairy facility within the north-central portion of the site. The barn structure is currently utilized for storing hay bales and agricultural equipment. The dairy facility consists of several structures including two single-family residences, barns, sheds and miscellaneous outbuildings. The eastern parcel portion of the site is currently utilized for livestock grazing for approximately 50 cattle and horses. This portion of the site is covered with grass vegetation. The western parcel portion of the site is currently utilized for hay production. This portion of the site is mowed regularly.

For the purposes of this report, the lowland portion of the site should be considered areas with an elevation of five feet above MSL or less. The upland portion of the site is considered areas greater than five feet above MSL. Topographically, the western 60% of the site (lowland portion) is flat and level with an elevation of approximately mean sea level (MSL). The eastern 40% of the site (upland portion) gently rises to an elevation of approximately 140 feet above MSL with the highest topographic point within the extreme northeast portion of the site.

Several shallow drainage ditches have been cut into the lowland portion of the site. The ditches are approximately three to five feet deep and divide the site into distinct sections, presumably for agricultural purposes. The upland portion of the site includes two moderately incised seasonal swales that drain to the adjacent lowlands to the south. The general site topography (five-foot elevation contours) is depicted on the Site Plan/Geologic Map, Figure 2.

Several wetland areas have been identified throughout the site. The wetland areas are characterized by specific vegetation and soil types. In general, the wetlands consist of broad low-lying areas within the western portion of the site and the seasonal drainage swales within the eastern portion of the site. Wetlands delineation activities are currently being performed by others at the site.

## **2.2 Project Description**

Specific details of the proposed project have not yet been determined. However, current conceptual plans call for an approximately 100-acre casino complex including a 300,000 square foot hotel-casino, two multilevel parking structures and additional at-grade parking areas. The casino will likely be multi-story (we assume five stories or less) with architectural features that require large spans. Therefore, we anticipate that foundation loads will be higher than typical for structures of this size. The multilevel parking structures will likely consist of cast-in-place, reinforced concrete structures. Access roads and at-grade parking areas will likely consist of asphalt concrete pavement overlying compacted aggregate base material.

Current conceptual plans have identified four scenarios for development of the casino complex within the Middle Section. Two scenarios involve development within the lowland areas and two scenarios involve development in the upland areas. The scenarios are described as follows:

- Scenario A1 – Development within the lowland central-western portion of the site.
- Scenario A2 – Development within the lowland south-western portion of the site.
- Scenario B1 – Development within the upland central-eastern portion of the site.
- Scenario B2 – Development within the upland north-eastern portion of the site.

### 3.0 SOIL AND GEOLOGIC CONDITIONS

The soil conditions observed in the exploratory borings and trenches were logged and classified in general accordance with American Society for Testing and Materials (ASTM) Standard Practice for Description and Identification of Soils (Visual-Manual Procedure). This procedure is based on the Unified Soil Classification System (USCS). The following soil descriptions include the USCS symbol where appropriate. Details of the field exploration equipment and methods are summarized in Appendix A.

Four general soil types were observed at the site. The soil types include, in order of increasing age: artificial fill, bay mud, alluvium and Tertiary-age Upper Petaluma Formation. In general, the alluvium is the result of the weathering of formational material. The Bay Mud is the result of sedimentation within the Bay. The alluvium forms an apron that generally divides the Bay Mud from the formational material and may interfinger with the Bay Mud. Approximately 60% of the site (about 250 acres) is underlain by Bay Mud deposits. The remaining 40 % (about 150 acres) is underlain by formational or alluvial deposits. The estimated lateral extent of the soil types, as determined by geologic field mapping and exploratory excavations, is depicted on the Site Plan/Geologic Map, Figure 2. Interpreted generalized cross-sections of the site geology are depicted on Figures 3 through 5. Discussion of the impacts of soil type on development is included in Section 5 of this report.

#### 3.1 Artificial Fill (af, afbm)

In general, the artificial fill material at the site is located within roadway or railroad improvements adjacent to the site. This material is mapped as artificial fill (af) and artificial fill placed over bay mud (afbm). It is assumed that the artificial fill has been placed in accordance with the guidelines of a construction quality control program with some degree of compaction. Therefore, the engineering properties of these materials are anticipated to be good. Exploratory excavations within the artificial fill material were not performed as a part of this study. Further evaluation of the existing artificial fill will be necessary if structural improvements are planned within this material.

#### 3.2 Alluvium (Qal, Qhf, Qpf)

The alluvial material observed at the site was (and is) derived from adjacent formational units. The alluvium is subdivided into alluvium (Qal), Holocene alluvial fan deposits (Qhf) and Pleistocene alluvial fan deposits (Qpf). In general, the composition of the different alluvial types is similar. The alluvium generally consists of dense and stiff mixtures of sand, silt, clay and gravels. Similar to the Upper Petaluma Formation, portions of the alluvium also contains thin layers of fat, potentially expansive clay (CH). The engineering properties of the alluvium is generally good, however, areas within active drainage swales may contain loose materials that would not be suitable for support of structures. Further evaluation of alluvium within the existing drainage swales will be necessary if development is planned in those areas.

### **3.3 Bay Mud (Qhbm)**

Holocene age Bay Mud deposits (Qhbm) are present within the lowland portion of the site. In general, the ground surface of the Bay Mud deposits is at or slightly above sea level. Based on the degree of consolidation and stratigraphic position, the sediments that comprise the Bay Mud can be subdivided into three subunits: Younger Bay Mud, Older Bay Mud and an alluvial sand unit that sometimes separates the two. These three subunits were observed at the site during exploratory activities.

#### **3.3.1 Younger Bay Mud**

The Younger Bay Mud at the site generally consists of very soft, saturated silty clay (CH) with varying amounts of decomposed organics. Very little (if any) fine sand was observed within the samples of the Younger Bay Mud. The material is firm in the upper five to six feet bgs due to drying and the very soft consistency of this deposit was evidenced by Standard Penetration Test (SPT, see Appendix A) blow counts less than five and very little tip resistance on the CPT cone. The engineering properties of Younger Bay Mud are very poor. The material has a high moisture content, low dry density, is very weak and compressible. This material is sensitive, it swells when wet and desiccates when dried. Furthermore, this material loses approximately 50% of its strength when disturbed.

The Younger Bay Mud at the site extends from the ground surface to a depth up to approximately 60 feet bgs. The deposit is thickest near the southwest corner of the site and gradually diminishes toward the north and east. The approximate lateral extent of the Younger Bay Mud is depicted on the Site Plan/Geologic Map, Figure 2. The approximate vertical extent of the Younger Bay Mud is depicted on the Geologic Cross-Sections, Figures 3 through 5.

#### **3.3.2 Alluvial Interface Sand Deposit**

The alluvial sand deposit located at the interface between the Younger and Older May Mud generally consisted of dense, gravelly, silty, clayey sand (SM, SC). In general, the engineering properties of this material are good. The granular nature provides increased shear strength.

This deposit was observed to be approximately 10 feet thick within Boring B4 and was interpreted to be approximately the same thickness in the CPT soundings. The approximate vertical extent of the alluvial interface sand deposit is depicted on the Geologic Cross-Sections, Figures 3 through 5.

#### **3.3.3 Older Bay Mud**

The Older Bay Mud at the site generally consists of stiff to very stiff, silty clay (CL, CH) and clayey silt (ML). Based on the CPT soundings, the Older Bay Mud extends to depths up to 140 bgs. Unlike the Younger Bay Mud, the engineering properties of this material are good. The material properties are usually adequate to support most pile foundations.

Similar to the Younger Bay Mud deposits, the deposit is thickest near the southwest corner of the site and gradually diminishes toward the north and east. This material is likely underlain by alluvial sands, gravels and clays or formational material of similar composition.

### **3.4 Upper Petaluma Formation (Tpu)**

Within the eastern portion of the site, the Upper Petaluma Formation consists of severely weathered material generally comprised of stiff to hard, silty, sandy lean clay (CL). This material has likely weathered from sandstone and siltstone. The severe degree of weathering has eliminated any visible bedding planes within this material. This material exhibits rock-like structure below approximately six feet bgs; however, the material remained readily excavatable to the backhoe and exploratory drill rig. The upper one to 1-½ feet of this material consists of highly plastic fat clay (CH) residual soil. We anticipate that this material has a moderate to high potential for expansion due to seasonal moisture variations. In general, the plasticity of this material decreases with depth. Other than the expansive nature of the surficial residual soils, the engineering parameters of this material are quite good. The estimated lateral extent of the Petaluma Formation is depicted on the Site Plan/Geologic Map, Figure 2.

### **3.5 Groundwater**

Groundwater was observed in several of the exploratory excavations during site investigative activities. In the lowland areas, groundwater was encountered at depths of approximately two to five feet bgs within the bay mud deposits. In the upland areas, groundwater and seepage was observed at depths ranging from approximately 20 to 25 feet within the upland alluvium and formational materials.

The groundwater within the lowland areas is primarily influenced by the adjacent San Pablo Bay. Therefore, groundwater elevations are expected to remain shallow and not fluctuate significantly throughout the year. However, the groundwater conditions within the upland areas are primarily influenced by precipitation and surface drainage discharge. During and immediately following periods of precipitation, shallow perched groundwater conditions can develop within the alluvial and formational deposits.

It must be noted that fluctuations in the level of groundwater may occur due to variations in rainfall, temperature, and other factors. Therefore, it is possible that groundwater may be higher or lower than the levels observed during our investigative activities.



## 4.0 GEOLOGIC HAZARDS

Several geologic hazards may potentially affect the site. Table 4.0 provides a brief summary of the potential geologic hazards associated with both the upland and lowland portions of the site. Discussion of the items presented in Table 4.0 is included in the following sections.

TABLE 4.0  
SUMMARY OF POTENTIAL GEOLOGIC HAZARDS

Development Area	Potential Geologic Hazards
Lowland Area	Seismic Impacts – ground shaking, liquefaction Mudwaves Expansive Soil Corrosive Soil Settlement Subsidence
Upland Area	Seismic Impacts – ground shaking Expansive Soil Slope Stability, Landslides

### 4.1 Seismic Impacts

The project site is within the seismically active San Francisco Bay Area and severe ground shaking is probable during the anticipated life of future development. Based on our analyses, no active or potentially active faults are known to cross the site and the potential for ground surface rupture is low. In addition, the site is not contained within a Special Studies Earthquake Fault Zone (formerly referred to as an Aliquist-Priolo Special Studies Zone).

#### 4.1.1 Ground Shaking

The site is located in a seismically active region, and as such, strong ground shaking would be expected during the lifetime of any construction projects. Ground shaking at the site could damage buildings and other structures and pose a threat to occupants. A critical factor affecting ground shaking intensity at a site is the geologic material underneath that site. Deep, loose or soft soils tend to amplify and prolong the shaking. Due to the differing geologic conditions at the site, ground shaking within the lowland portion of the site is anticipated to be amplified compared to that of the upland areas. Anticipated peak site accelerations for both areas of the site are presented below.

In order to determine the distance of known "active" and "potentially active" faults to the site, we reviewed available seismic/geologic literature (see *List of References*, Section 7.0 of this report) and utilized the computer program EQFAULT, Version 3.00 (Blake, 1988, updated 1999) was utilized. A search radius of 62 miles was performed and the five closest known active faults were identified. Principal references used within EQFAULT in selecting faults to be included were Jennings (1975), Anderson (1984) and Wesnousky (1986). In addition to fault location, EQFAULT was used to

deterministically estimate ground accelerations at the site. Attenuation relationships presented by Boore et al. (1997) were used to estimate site accelerations.

The results of the seismicity analyses indicate that the potentially active Tolay Fault Zone is located approximately 1,500 feet northeast of the site. However, based on the literature reviewed for the Tolay Fault, the fault is not considered "sufficiently active and well defined" by the California Geological Survey (CGS). Therefore, special fault zoning does not apply for this fault zone.

The active Rodgers Creek Fault Zone is located approximately 2.7 miles northeast of the site. The active Hayward Fault is located about 6.5 miles to the south and the active San Andreas Fault is located about 18 miles to the west. The Rodgers Creek Fault has a Maximum Credible Earthquake (MCE) moment magnitude ( $M_w$ ) of 7.0. This fault is considered to be the source of the greatest seismic ground shaking at the site. The MCE is defined as the maximum earthquake that appears capable under the presently known tectonic framework.

Table 4.1 presents a summary of the significant active faults identified, their distance from the site, and a summary of potential ground shaking effects for both the lowland and upland portion of the site. The information presented on Table 4.1 was derived from the seismic analyses utilizing EQFAULT with attenuation relationships by Boore et al (1997) used to estimate the maximum credible peak site accelerations.

**TABLE 4.1  
DETERMINISTIC SITE PARAMETERS**

Fault Name	Approximate Distance from Site (miles)	Maximum Credible Earthquake Moment Magnitude ( $M_w$ )	Lowland Areas	Upland Areas
			Maximum Credible Peak Site Acceleration (g)	Maximum Credible Peak Site Acceleration (g)
Rodgers Creek	2.7	7.0	0.47	0.37
Hayward	6.5	7.1	0.33	0.26
West Napa	11	6.5	0.17	0.13
Concord – Green Valley	18	6.9	0.15	0.11
San Andreas	19	7.9	0.24	0.19

### **4.1.2 Liquefaction**

Soil liquefaction is a condition where saturated granular soils near the ground surface undergo a substantial loss of strength during seismic events. Liquefaction can result in ground surface deformations and settlement. Soils most susceptible to liquefaction are loose, uniformly-graded, fine-grained, sand and loose silts with low cohesion. It is our opinion that the potential for liquefaction ~~are~~ slight to nonexistent within the upland portions of the site. Although not observed during our investigation, Bay Mud deposits within the lowland portion of the site can contain lenses of saturated, granular material. These materials may be subject to liquefaction during a seismic event. If the lowland portion of the site is chosen for development of the casino complex, liquefaction potential will be evaluated during future subsurface studies.

### **4.1.3 Lateral Spreading**

Lateral spreading during a seismic event typically occurs as a form of horizontal displacement of relatively flat-lying alluvial or sediment deposits toward an open or "free" face such as an open body of water, channel or excavation. Generally, in soils this movement is due to failure along a weak plane, formed within an underlying liquefied layer. As cracks develop within the weakened material, blocks of soil displace laterally towards the free face. Subsurface conditions indicate that potentially liquefiable sand layers beneath the site are non-existent or relatively thin and isolated; therefore, the potential for lateral spreading is considered low.

### **4.1.4 Seismically Induced Flooding**

San Pablo Bay is well protected from tsunami (a great sea wave produced by a submarine earthquake) emanating from the Pacific Ocean. The site, located north of undeveloped agricultural land that borders the Bay, is unlikely to be impacted by tsunami and/or seiche waves.

## **4.2 Slope Stability, Landslides**

According to geologic literature, the Upper Petaluma Formation within the upland area of the project (see Site Plan/Geologic Map, Figure 2) is prone to landsliding. However, the existing gradients within this portion of the site are not considered steep enough to present an unstable condition at the current configuration. Additionally, the formational material encountered in the exploratory test pits and borings was severely weathered with no evident bedding planes. However, adverse bedding planes can exist in less-weathered portions of this formation. Deep cuts within this material may expose adverse bedding planes which can lead to unstable slope conditions particularly when saturated and subjected to seismic activity.

## **4.3 Mudwaves**

Mudwaves can occur when fill embankments are constructed rapidly over a relatively thick layer of weak Bay Mud. A mudwave is the displacement of the soft Bay Mud supporting an embankment under the weight of a new fill load. Due to the presence of the thick layer of Younger Bay Mud, mudwaves

are possible within the lowland areas of the site. If the lowland portion of the site is chosen for development, specific mitigation measures for mudwaves should be a part of future design level geotechnical studies at the site.

#### **4.4 Expansive Soil**

Expansive soils are present across the surface of both the lowland and upland portions of the site. If unmitigated, expansive soils subjected to seasonal moisture variations may cause damage to overlying structures or shallow utilities. Specific mitigation measures for expansive soils should be a part of future design level geotechnical studies at the site.

#### **4.5 Corrosive Soil**

Typically, soil is considered corrosive to reinforced concrete and steel if the soluble salt (chloride and sulfate) content is high. In general, cohesive soils are more corrosive than granular soils, especially cohesive soils that are close to salt water bodies. Therefore, the Bay Mud materials within the lowland portion of the site may be potentially corrosive. Soil within the upland portion of the site is less likely to be corrosive. If the lowland portion of the site is chosen for development, a corrosion evaluation should be a part of future design level studies at the site.

#### **4.6 Settlement**

Total settlement within the lowland area of the site will be comprised of consolidation settlement of the soft, Younger Bay Mud materials resulting from external loading and long-term subsidence. Based on the subsurface conditions within the lowland portion of the site, consolidation settlement can be significant (up to several feet) depending on surface loading conditions. Differential settlement of these materials may also occur, meaning portions of the site may settle different amounts or at different rates. If the lowland portion of the site is chosen for development, a detailed settlement analysis should be a part of future design level geotechnical studies at the site.

#### **4.7 Subsidence**

Subsidence of the Bay Mud deposits can be caused by dewatering activities or the decomposition of organic matter within the Bay Mud. Currently, it is planned install a domestic well within the lowland portion of the site. The well will withdraw water from a deeper, alluvial aquifer that is expected to be hydraulically disconnected from the hydrologic conditions in the Younger Bay Mud. We have installed a piezometer (P1) within the Younger Bay Mud to monitor the groundwater conditions within the Bay Mud during the planned pump test for the new well. Depending on the results of the monitoring, subsidence may be an issue that may impact development in this area.

Decomposition of organic matter within the Bay Mud is a regional, on-going phenomenon. Since Bay Mud is typically an anaerobic environment, the rate of decomposition is typically very slow. Factors that may increase the rate of decomposition include the introduction of oxygen into the soil matrix,

such as from dewatering. Proposed development at the site is not anticipated to significantly alter the aerobic conditions within the Bay Mud. Therefore, the magnitude of subsidence from decomposition of organics is considered to be very low.

## 5.0 CONCLUSIONS AND RECOMMENDATIONS

### 5.1 General

In our opinion, the soil and geologic conditions at the site do not preclude development of the project as currently proposed. Depending on the location chosen for development, specific geotechnical challenges will need to be addressed. Table 5.1 presents a summary of the anticipated geotechnical conditions that may impact development on the project. The delineation between the lowland and upland areas is defined in Section 2.1.

**TABLE 5.1  
PRIMARY GEOTECHNICAL CONDITIONS**

Development Consideration	Lowland Area	Upland Area
Grading - Earthwork	Difficult clay soils for construction Easy excavation characteristics Shallow groundwater Minor cut/fill required Import fill soil required	Good soils for construction Moderate excavation characteristics Minor, intermittent groundwater Moderate cut/fill required for building pads Subdrains required
Foundations	Deep foundations required Limited bearing capacities Potential settlement problems Corrosive Soil Potential	Shallow or intermediate foundation systems suitable
Structures	Higher seismic loading	Lower seismic loading
Underground Utilities	Dewatering required Trench wall stability problems Difficult maintaining slope on gravity lines Flexible utility line materials may be required	Minor dewatering required Stable trench walls
Pavement	Unstable/pumping subgrade Thicker sections required	Good support conditions Cut/fill required

The following sections provide specific discussion of the various areas of site development that may be impacted by the geological/geotechnical conditions present at the site. These conclusions are preliminary in nature and are intended for planning purposes. Detailed recommendations can be provided in future geotechnical studies which would be based upon specific site development plans and more detailed geotechnical information obtained from subsurface studies.

## 5.2 Grading – Earthwork

The subsurface conditions present on the site vary significantly from the lowland to the upland areas. Accordingly, the conditions encountered during earthwork for the project are expected to vary significantly. Table 5.2, below, summarizes the primary conditions expected during site grading. Detailed descriptions of the conditions are discussed in the following sections for the different areas.

**TABLE 5.2  
ANTICIPATED GRADING CONDITIONS**

<b>Development Area</b>	<b>Anticipated Conditions During Grading</b>
Lowland Area	Easy excavation characteristics Difficult soils to work in – saturated, soft clay Small cut/fill volumes Import fill soil required Very shallow groundwater table Large shrinkage due to compaction Corrosive Soil Potential
Upland Area	Moderate excavation difficulty Good soils to work in Moderate cut/fill volumes Subdrains required Minor groundwater impact Typical compaction shrinkage

### **5.2.1 Lowland Area**

The lowland portion of the site is flat, level, and is at, or only slightly above, sea level. The lowland portion of the site is underlain by Bay Mud deposits. Groundwater is very close to the existing ground surface and the soils are soft, highly plastic clays and organic clays. These soils will present difficult grading conditions, particularly if grading occurs during the wetter winter or spring months of the year. Equipment maneuverability is expected to be very difficult in the wet season and adequate but soft in the dry season.

Due to the exceptionally low dry densities and corresponding high water contents of the in-situ soils, construction of engineered fills will be challenging. Due to the proximity of groundwater to the existing ground surface, establishing a firm base for constructing fills will likely be very difficult in some areas, depending on the specific conditions. Pumping, unstable subgrade conditions may be quite common when trying to establish a firm base for building pads or roadways. Proper compaction requires that the water content be near optimum for compaction to occur. Other than the very-near surface soils, the in-situ water contents are in the range of 70% to 100%. Typical clay soils have optimum water contents in the range of 15% to 20%. Drying this amount of water out of a soil will not only require the weather to cooperate, but it will also require a significant amount of time to accomplish.

In addition to the exceptionally large water contents are exceptionally small dry densities. Recompact the native soils as engineered fill will require raising the dry density (by compaction) from the current range of 40 to 70 pound per cubic foot (pcf) to approximately 90 to 110 pcf. Achieving the degree of compaction typically required in construction will likely be difficult due to the difficulty of compacting over marginally stable soils. Significant increases from a "normal" amount of shrinkage from cut to fill should be expected if the native soils are used as compacted fill. Also, the native soils appear to have a significant amount of organic material in the soil matrix. Because of the organic content, it is possible that some of the native soils in the lowland area may be deemed unsuitable for use as engineered fill. Therefore, import fill soil may be required.

As discussed in Section 4.5, the native soil within the lowland area is potentially corrosive to reinforced concrete and/or steel. If the lowland portion of the site is chosen for development, a corrosion evaluation should be a part of future design level studies at the site.

### **5.2.2 Upland Area**

The upland area primarily consists of the eastern 40% of the site. General earthwork and grading activities in the upland area are expected to be significantly better than those of the lowland area. Soft soils, low density soils, high water content soils and organic soils are not expected to be an issue in the upland area. Depending on the time of year, there may be some groundwater present; however, it is expected to be more of an intermittent, or perched water situation. Groundwater interference, if encountered should be much less severe, since the water may be between layers which may be able to be contained, cutoff or directed into a subdrain system. Establishing a firm base for construction of fills will likely be accomplished without difficulty in the upland areas. However, localized areas of soft, surficial soils may require removal or recompact. Dewatering can likely be accomplished using diversion ditches or temporary culverts. Drying wet soils should be much less time consuming than the lowland area since the in-situ water contents should be relatively close to the optimum water content.

The predominant soil types expected in the upland area will be much more favorable for grading activities than those in the lowland area. The soils are generally more granular, making fill construction and achieving compaction much easier. Excavation into the native materials in the upland area will likely be able to be performed with conventional heavy-duty grading and excavation equipment with a moderate degree of difficulty. Native formational rock does underlie this area; however, it is not expected to become so hard that special grading or blasting would be required for the cuts anticipated for this project.

Some oversize rock or cemented fragments may be generated during excavation of some of the deeper cuts within the formational units. It is anticipated that most of the larger rock fragments can be broken down to suitable particle sizes by track-walking or standard compaction effort.



In general, cut or fill slopes likely can be constructed at inclinations on the order of 2:1 (horizontal to vertical). However, there does appear to be a potential for adversely aligned bedding planes in the underlying rock formation that may impact construction of slopes. This situation should be investigated in more detail as part of future geologic/geotechnical work on the site. At this point in time, this condition is not envisioned as a major obstacle, but may require slight flattening of some slopes in the development or other, more subtle procedures.

### 5.3 Foundations

Due to the significant variations in the subsurface conditions between the lowland area and the upland area there will be significant differences in the required foundations for similar structures built in the two areas. Table 5.3, below, summarizes the anticipated types of foundations that would likely be necessary for construction of the casino complex in the two areas. More detailed descriptions of the foundation systems are presented in the following sections.

**TABLE 5.3  
GENERALIZED FOUNDATION REQUIREMENTS**

Development Area	Anticipated Foundation Systems	
	Heavily Loaded Structures	Lightly Loaded Structures
Lowland Area	Driven precast concrete piles Post-tensioned or structural mat	Post-tensioned or structural mat
Upland Area	Isolated and/or strip footings Drilled piers	Isolated and/or strip footings

#### 5.3.1 Lowland Area

The upper 50 to 60 feet of the existing soils within the lowland area are very soft and groundwater is very close to the surface. Because of these conditions, adequate support of structural loads will be more complicated than the upland area where stronger soils are present. Because of the potential for subsidence, low shear strength and low lateral resistance, heavier structural loads will likely require a deep foundation system for support. These heavy loads may be the result of a larger structure, or they may result from a larger span within a smaller structure. Vertical loads can likely be supported on piles driven into the underlying, stiffer Older Bay Mud in the depth range of 60 to 90 feet bgs. It is anticipated that tolerable settlement would result for piles loaded in the 30 to 60 Tons per pile range. It should be noted that although the vertical loads may be able to be adequately supported by piles, lateral loads may be a problem. Since the native materials are very soft, the ability to resist a horizontal force, as would be imparted from a pile with moment applied at its top, will be low. Depending on the actual loading scenario, this may require special structural design to minimize or eliminate lateral loads or moments applied to piles.

Another design consideration is the possibility of a downdrag force being applied to pile foundations as a result of subsidence of the Younger Bay Mud (as discussed in Section 4.7). Subsidence could cause a negative skin friction that increases the downward force on the piles. If the downdrag force is small, it

may not cause enough additional downward deflection to be significant. However, if the downdrag is significant, it may be necessary to design specific measures to minimize the downdrag loading of the piles. This may include disconnecting the upper portion of piles from the stratum using casing, or preloading the area to initiate consolidation before the pile is installed.

The use of a structural mat foundation was also listed in Table 5.3 as a possible foundation type. These foundations could take the form of a post-tensioned slab or a more heavily-reinforced slab foundation. The concept would be to isolate a structure, or portion of a structure, on the mat and design it to act as a unit, rather than allowing portions of a structure to move independently which may result in distress to the structure. This foundation system would probably be more applicable to lightly loaded structures; however, if designed accordingly, it could be used for heavier structures.

### **5.3.2 Upland Area**

The upland area consists of more competent soils and soft rock. Foundations in this area can therefore consist of more conventional shallow systems for heavy or light structures. Although there may be some intermittent groundwater, it is not expected that it will be a significant problem for construction of foundations in dry construction season. If construction does take place during the wetter season, both surface water and groundwater may be a significant problem. It is anticipated that most groundwater in this area can be handled by constructing subdrains, creating diversion ditches, small dewatering systems or pumping directly from foundation excavations.

Larger structural loads could be supported upon drilled piers or driven piles; however, it is anticipated that drilled piers would be more appropriate since pile driving may be difficult in the deeper zones as the less-weathered sedimentary rock is penetrated. Drilled piers should be able to be constructed with reasonable resistance to the required depths. Drill holes should stand open and belling would be possible, if needed for additional capacity.

Isolated spread footings or strip footings would be appropriate for either heavy or lightly loaded structures. Light loads can likely be supported upon footings extending only one or two feet into the existing ground. More heavily loaded structures may need to have footings embedded two to five feet into the existing ground.

## **5.4 Structures**

Due to the amplification effect of seismic shaking by the Bay Mud, different seismic site accelerations for the upland and the lowland areas were presented in Section 4.1. Accordingly, the horizontal forces applied to similar structures will be significantly greater in the lowland area, as compared to that in the upland area. It is recommended that these differences be evaluated, not only in terms of the risk of damage, but in terms of the cost of the structure in the two areas due to the different design loads.

## 5.5 Underground Utility Construction

Due to the variations in the subsurface conditions between the lowland area and the upland area there will be significant differences in the trenching conditions and long-term performance of underground utilities. Table 5.5, below, summarizes the anticipated trenching conditions for the two areas. More detailed discussion is presented in the following sections.

**TABLE 5.5  
GENERALIZED TRENCHING CONDITIONS**

<b>Development Area</b>	<b>Anticipated Trenching Conditions</b>
Lowland Area	Easy excavation Trench wall stability problems Major dewatering problem below 5 feet Difficult maintaining slope on gravity lines Flexible utility line materials may be required
Upland Area	Moderate excavation difficulty Relatively stable trench walls Minor/intermittent groundwater interference

### 5.5.1 Lowland Area

Trenching in the lowland area will be very easy in terms of excavation difficulty; however, groundwater will be a significant problem. Groundwater is typically about two to four feet bgs in most of the lowland area. This will make most trenches very wet, except for only the very shallow ones. Inflow to trenches is expected to be relatively large and continuous since the groundwater in this area is a water table, not just intermittent, seasonal water.

Due to the extremely weak, organic soils, trench wall stability will likely be a problem. Shoring of trench walls will probably be required, even in relatively shallow trenches.

Trench backfill will probably be expensive due to the very high water content, low density and general unsuitability of the native materials. Import will likely be necessary for much, or possibly, all of the backfill in this area.

Settlement of Bay Mud could result in adverse flattening of gravity utility slopes and lead to a reversal of flow direction or inadequate velocities to prevent accumulation within pipes. Second, differential settlement may also cause separation of utility lines at joints, resulting in leakage or interruption in service. Standard materials for utility piping, such as polyvinyl chloride (PVC) and reinforced concrete pipe (RCP) are single walled systems with a limited ability to accommodate large differential settlements. The joints of standard piping materials are typically joined using slip-on couplings with rubber gaskets. These joints are subject to separation and leakage when subjected to differential

settlement. The use of alternate utility line material or the design of flexible joints may be necessary if the lowland area is chosen for development.

### **5.5.2 Upland Area**

The upland area is expected to have significantly better conditions for construction of underground utilities than the lowland areas. Groundwater should not be a problem, or it should only be a minor problem. It is anticipated that whatever groundwater there may be can be handled relatively inexpensively by diversion ditches or pumping from sumps within the trenches. Trenching in this area should be able to be accomplished with a moderate amount of resistance which would increase with depth. It is expected that conventional equipment will be adequate to perform trenching to standard utility depths on the order of five to 10 feet bgs. Deeper trenches will likely become more difficult, and may require larger equipment.

It is anticipated that most materials excavated from the trenches in the upland area will be useable as backfill in the trench. Rock fragments should break down to suitable sizes with moderate effort.

### **5.6 Pavement - Roadways**

Roadway design and construction will be significantly different between the lowland and upland areas due to the variations in the subsurface conditions. Table 5.6, below, summarizes the anticipated differences for roadways in the two areas. A more detailed discussion of the roadway conditions is presented in the following sections.

**TABLE 5.6  
GENERALIZED PAVEMENT CONSTRUCTION CONDITIONS**

<b>Development Area</b>	<b>Anticipated Pavement Area Conditions</b>
Lowland Area	Subgrade stability problems Potential groundwater interference Minor cut/fill required Thicker pavement sections Asphalt concrete pavement only
Upland Area	Stable subgrade soils Little/seasonal groundwater Cut/fill volumes Moderate pavement section thickness Asphalt concrete or Portland cement concrete pavement

#### **5.6.1 Lowland Area**

Due to the poor soils and high groundwater present in the lowland area, pavement sections will likely be significantly thicker in the lowland area compared to those in the upland area. Total pavement section thicknesses may be in the range of 30 inches, depending on the amount of traffic for which the roadways are designed. Additional overexcavation of underlying subgrade soils may be required beyond the section thickness to establish a firm base for the roadway section.

Roadways will likely be constructed upon raised embankments which will introduce additional loading on the weak soils underlying the area. This will almost certainly result in a degree of consolidation settlement which will take time (on the order of one to 10 years) to complete. The magnitude of these induced settlements could be relatively large (on the order of 1 to 10 inches or more). Another phenomenon associated with constructing large area fills on soft Bay Mud is the possibility of developing what is known as a mudwave (as described in Section 4.3). Due to the exceptionally low strength of the Bay Mud, a large scale movement can occur in adjacent, unloaded ground. Mudwaves are slow to develop and may occur over a period of months or years. The risk of developing a mudwave can be reduced by reducing the loading, applying the load gradually, incremental preloading of the area, or providing improved drainage within the mudwave area.

Since embankments will likely need to be constructed for roadways, it is likely that a surcharge or preload fill may be necessary. These surcharge fills would function to initiate consolidation of the underlying stratum, prior to building the finished structure. This will reduce the ground surface elevation in the area (requiring fill to make up the lost volume), lower the water content, increase the dry density and strengthen the underlying materials. All of these results, except lowering the ground surface elevation, will improve the overall constructibility of the area. In addition to the earthwork costs of building a preload fill, there is a cost in terms of time. Typically, a surcharge, or preload fill will need to remain in place for a period of one to three years to accomplish a reasonable degree of soil improvement. If the fill is in an area where it will be used as a final component of the project, such as a roadway embankment, then it can be built to the final height and would be known as a preload fill. Alternatively, if the area is built higher than its finished grade to cause the desired consolidation to occur more rapidly, then it is known as a surcharge fill. In this case the additional fill height is temporary and it would ultimately be removed.

Considering the potential problems with constructing pavement areas in the lowland area, it is recommended that pavement in this area be limited to flexible pavement, such as asphalt concrete. Rigid pavements, such as Portland cement concrete paving, could be used; however, the probability of damage due to differential subgrade movement would be significantly higher than that for flexible paving.

### **5.6.2 Upland Area**

It is anticipated that the upland area will have much better grading conditions for roadway construction compared to the lowland area. The subgrade strength should be significantly greater which will result in substantially thinner pavement sections. It is expected that typical total pavement sections in the upland area would be 10 to 12 inches thinner than those in the lowland area. Large, exceptionally soft areas are not expected so establishing a firm base for fills should not require overexcavation. The more typical scenario for base preparation would be basic scarification and recompaction of the existing

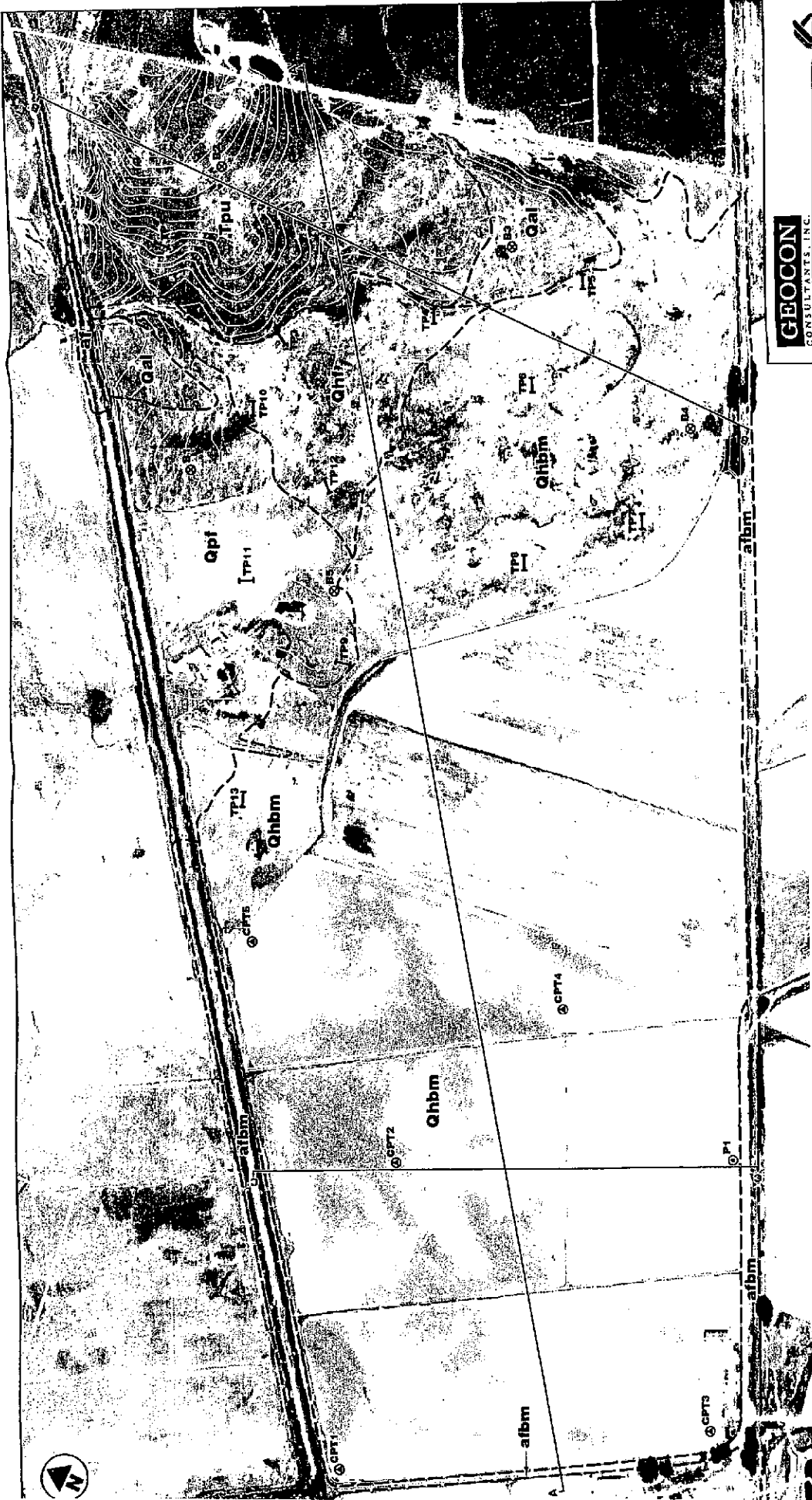

**GEOCON**  
 CONSULTANTS, INC.  
 11575 SUMMIT DRIVE, SUITE 111, NANGHIC COASTAL PT. 94742  
 PHONE 916-625-3131 FAX 916-625-3132

Sonoma Casino  
 Sonoma County,  
 California

**SITE PLAN/GEOLOGIC MAP**

S6689-06-01 June 2003 Figure 2

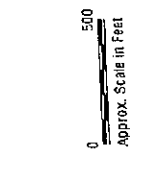

- EGEND:**
- TP1 Approximate Trench Location
  - B1 Approximate Exploratory Boring Location
  - P1 Approximate Temporary Piezometer Location
  - CPT1 Cone Penetration Test Sounding
  - A Approximate Geologic Cross-Section Location
  - Elevation Contour Interval = 5 Ft.
  - Approximate Geologic Contact
  - af Artificial Fill
  - afbm Artificial Fill placed over Bay Mud
  - Qhbm Holocene Bay Mud
  - Qal Quaternary Alluvium
  - Qhf Holocene Alluvial Fan
  - Qpf Pleistocene Alluvial Fan
  - Tpu Upper Pajaluma Formation

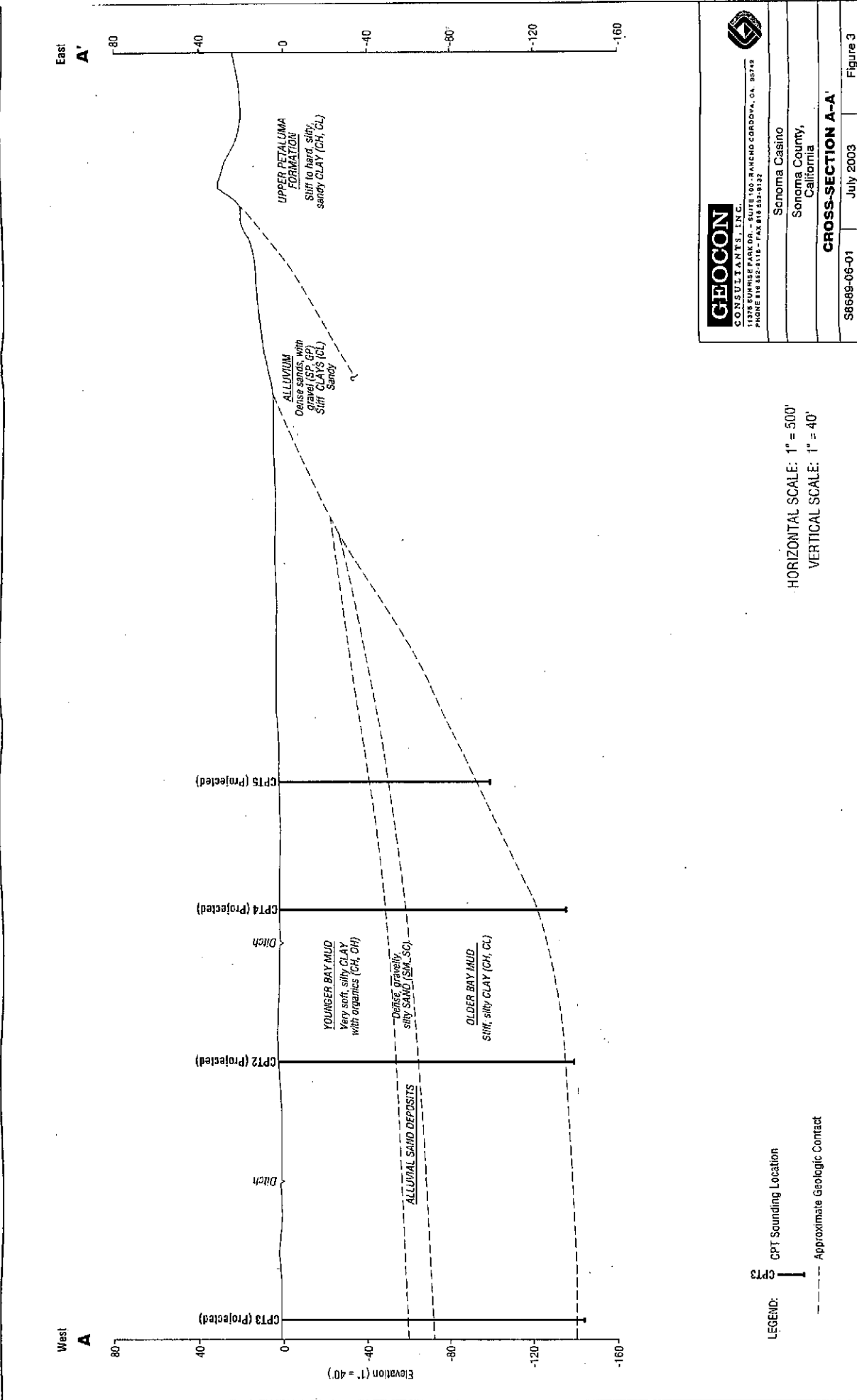

**GEOCON**  
CONSULTANTS, INC.  
1376 SUNNYSIDE PARK DR. - SUITE 100 - RANCHO CORDOVA, CA 95748  
PHONE 916 852-8118 - FAX 916 852-9132

Sonoma Casino  
Sonoma County,  
California

**CROSS-SECTION A-A'**

S8689-06-01 July 2003 Figure 3

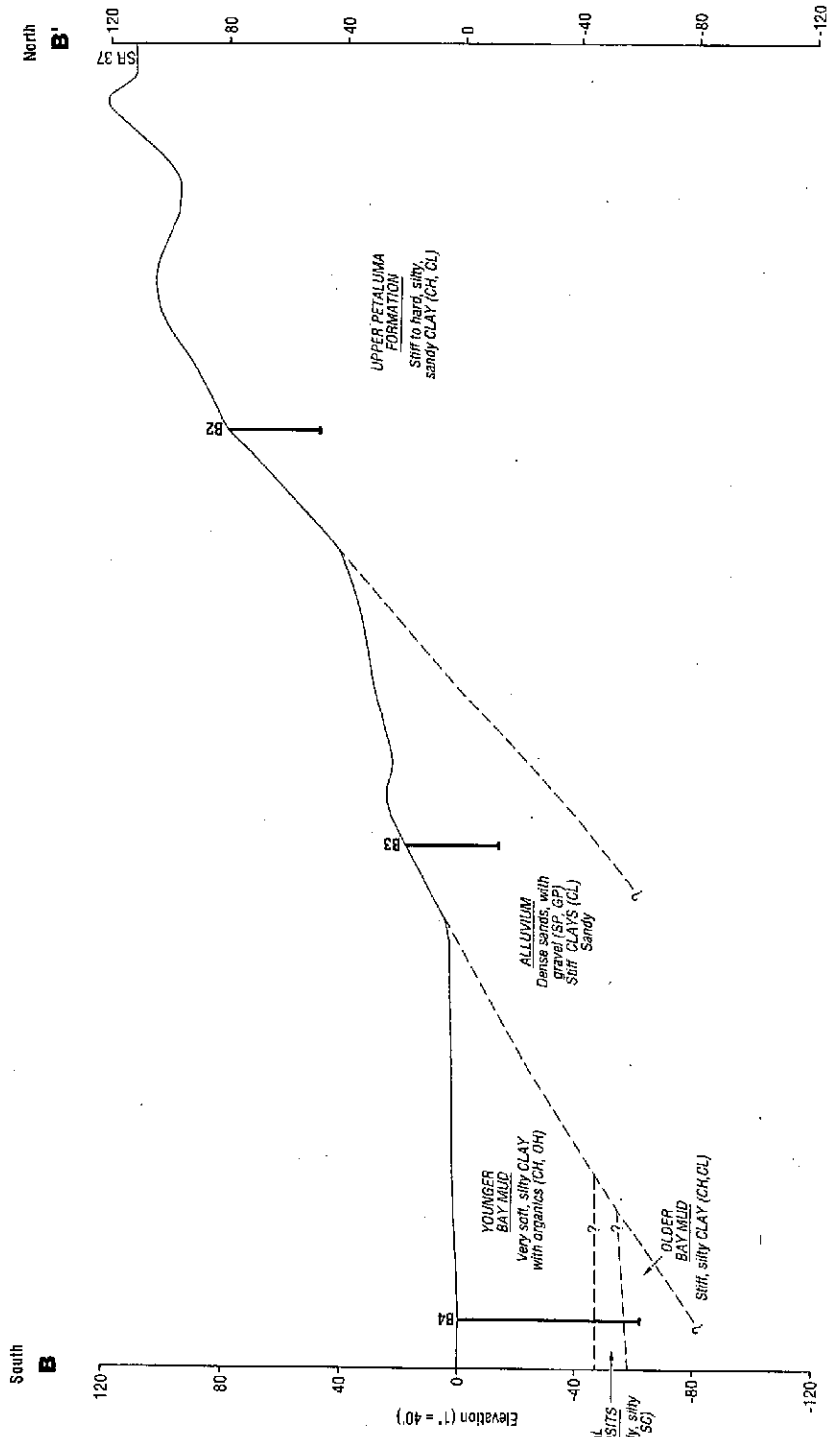

**GEOCON**  
CONSULTANTS, INC.  
1750 SURFERS PARK DR., SUITE 100, ARNHEIM CORRDVA, CA 95742  
PHONE 925.265.4111 / FAX 925.265.1532

Sonoma Casino  
Sonoma County,  
California

**CROSS-SECTION B-B'**

S8889-06-01 July 2003 Figure 4

HORIZONTAL SCALE: 1" = 400'  
VERTICAL SCALE: 1" = 40'

LEGEND:

— Boring Location

- - - - - Approximate Geologic Contact



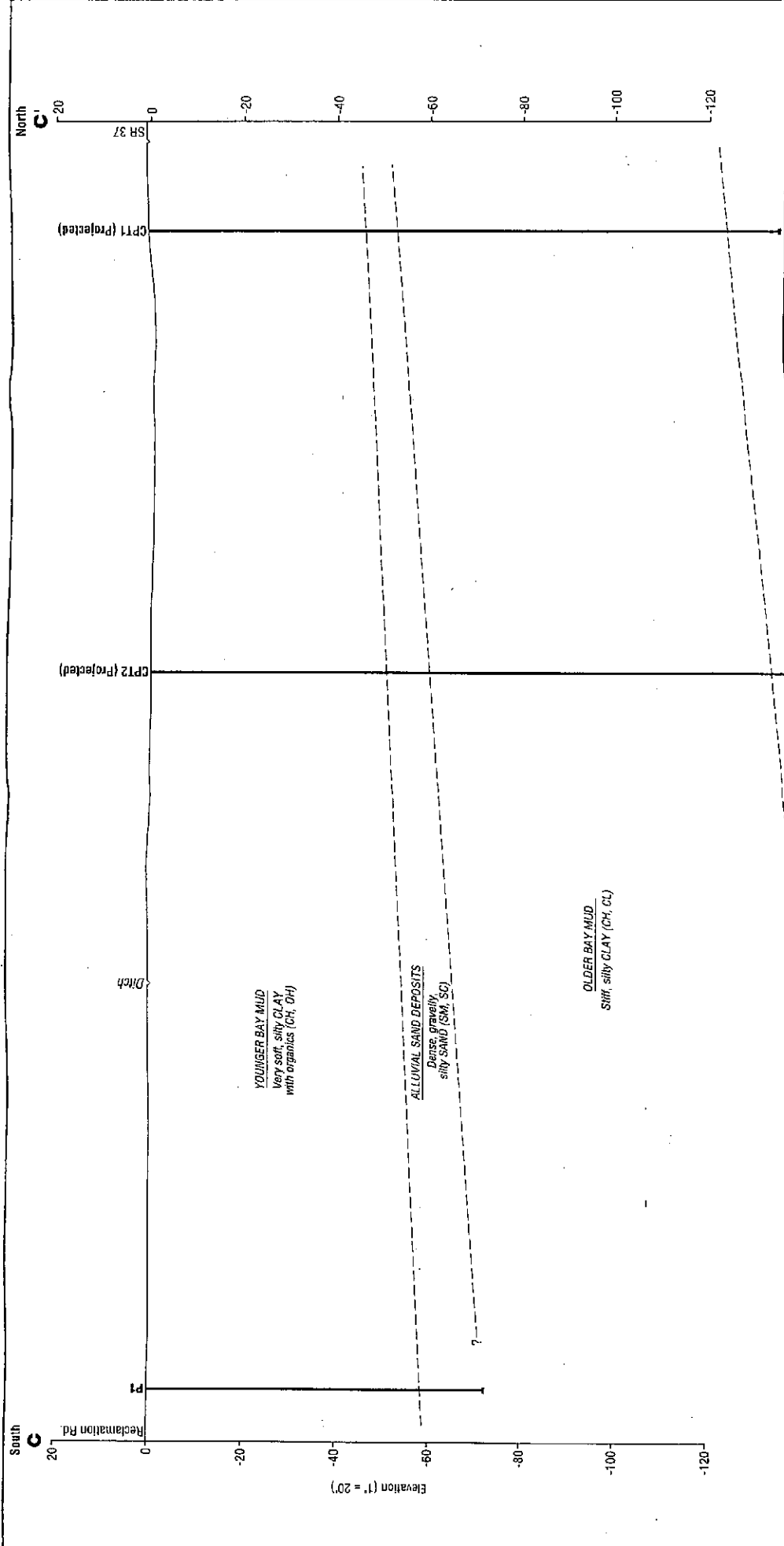

**GEOCON**  
CONSULTANTS, INC.  
11375 SUNRISE PARK DR., SUITE 100 - RANCHO CORDOVA, CA. 95742  
PHONE 916 852-8112 - FAX 916 852-8132

Sonoma Casino  
Sonoma County,  
California

**CROSS-SECTION C-C'**

S8689-06-01 July 2003 Figure 5

HORIZONTAL SCALE: 1" = 200'  
VERTICAL SCALE: 1" = 20'

LEGEND:  
 — CPT Sounding/Boring Location  
 - - - Approximate Geologic Contact

materials in place. Groundwater should only be a minor hindrance and would likely only be an issue in the lower swales, and may only be an issue in the winter-spring months of the year.

Due to the hilly terrain in the upland area, cut/fill volumes will likely be greater than those in the lowland area. Excavations in this area are expected to be readily accomplished with standard grading equipment with a moderate amount of difficulty.

Either asphalt or concrete paving would function satisfactorily in the upland area. Long term settlement or heaving would generally not be expected in this area, reducing the on-going maintenance costs.

#### **5.7 Future Project Plans**

Prior to finalization of the grading and development plans for the property, a design-level geotechnical investigation addressing the specific grading and development plans should be performed. The investigation should provide site specific grading recommendations, recommendations for mitigation of adverse soil conditions and preliminary foundation design criteria.

## 6.0 LIMITATIONS AND UNIFORMITY OF CONDITIONS

The recommendations of this report pertain only to the site investigated and are based upon the assumption that the soil conditions do not deviate from those disclosed in the investigation. If any variations or undesirable conditions are encountered during construction, or if the proposed construction will differ from that anticipated herein, Geocon should be notified so that supplemental recommendations can be given. The evaluation or identification of the potential presence of hazardous or corrosive materials was not part of the scope of services provided by Geocon.

This report is issued with the understanding that it is the responsibility of the owner, or of his representative, to ensure that the information and recommendations contained herein are brought to the attention of the architect and engineer for the project and incorporated into the plans, and the necessary steps are taken to see that the contractor and subcontractors carry out such recommendations in the field.

The findings of this report are valid as of the present date. However, changes in the conditions of a property can occur with the passage of time, whether they be due to natural processes or the works of man on this or adjacent properties. In addition, changes in applicable or appropriate standards may occur, whether they result from legislation or the broadening of knowledge. Accordingly, the findings of this report may be invalidated wholly or partially by changes outside our control. Therefore, this report is subject to review and should not be relied upon after a period of three years.

## 7.0 LIST OF REFERENCES

1. Environmental Constraints Analysis Report, Southern Sonoma County Property (Sections 3 and 4), prepared for Kenwood Investments by CH2MHill, January 2003.
2. Geologic Map of the Sears Point 7.5' Quadrangle, Sonoma, Solano and Napa Counties, California: A digital Database, Version 1.0, California Geological Survey, 2002.
3. Geologic and Engineering Aspects of San Francisco Bay Fill, Special Report 97, California Division of Mines and Geology, Ferry Building, San Francisco, 1969 *City of San Diego, Seismic Safety Study, Geologic Hazards And Faults*, sheet 43, Development Services
4. Fault Evaluation Report FER-140, Tolay Fault, California Division of Mines and Geology, July 29, 1982
5. Fault Evaluation Report FER-141, Rogers Creek, California Division of Mines and Geology, September 27, 1982

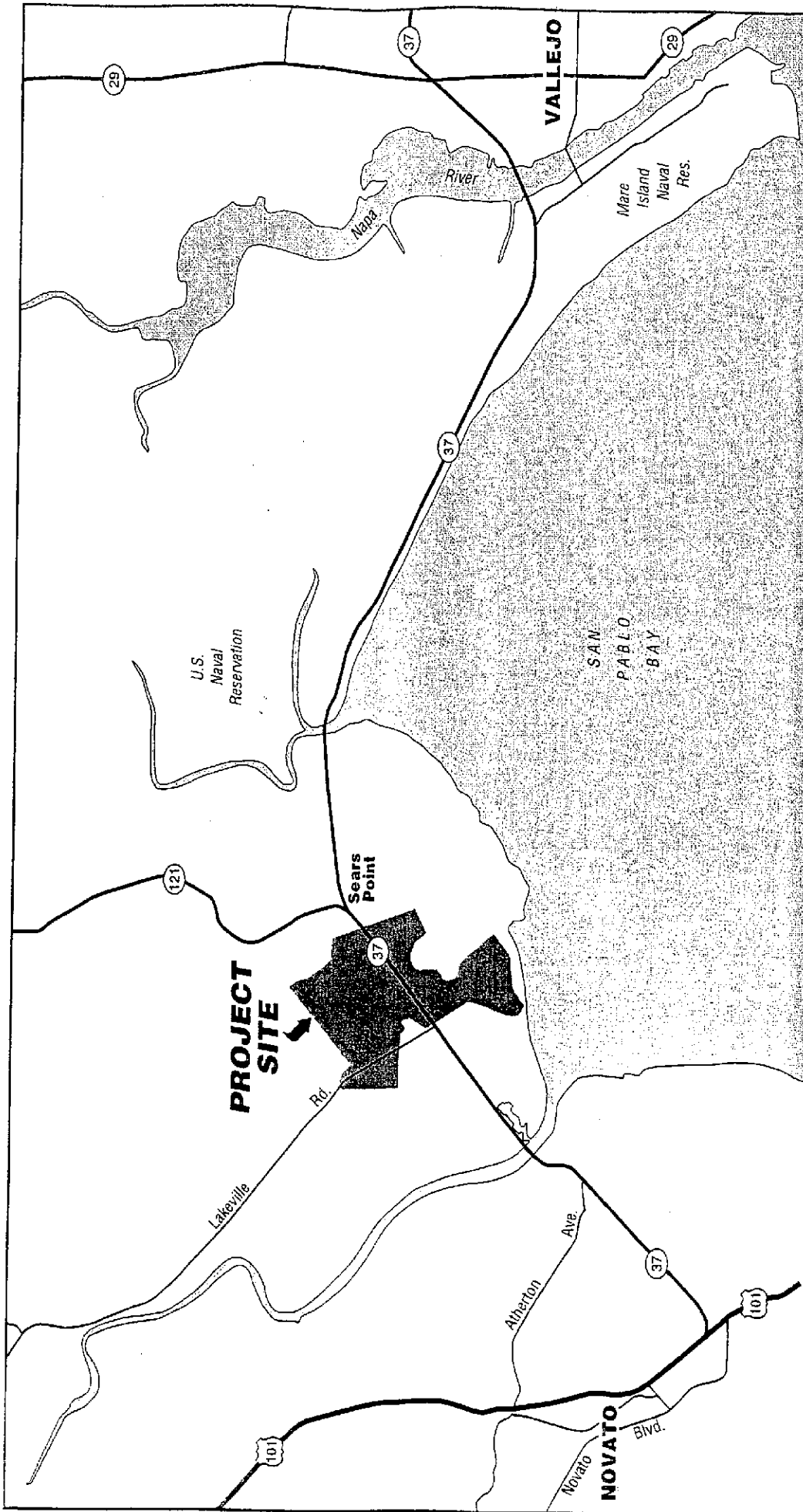

**GEOCON**  
 CONSULTANTS, INC.  
 11375 SUNRISE PARK DR. - SUITE 100 - RANCHO CORDOVA, CA. 95742  
 PHONE 916 852-9118 - FAX 916 852-9132



Sonoma Casino  
 Sonoma County,  
 California

**VICINITY MAP**

S8689-06-01

June 2003

Figure 1

APPENDIX

A

## APPENDIX A

### FIELD INVESTIGATION

The field investigation was performed during the period of May 21 through June 4, 2003. The field investigation consisted of the excavation of 13 exploratory trenches (T1 through T13), 6 exploratory borings (B1 through B5 and P1), and 5 CPT soundings (CPT1 through CPT5) at the approximate locations shown on Figure 2.

The exploratory trenches were excavated with a rubber tire backhoe equipped with an 18-inch bucket. Relatively undisturbed samples were obtained by driving a 3-inch O.D. hand-held sampler into the "undisturbed" soil mass with blows from a 5-pound hammer falling 18 inches. The sampler, equipped with 6-inch by 2-3/8-inch brass sample tubes to facilitate removal and testing, was driven 6 inches into the soil. Disturbed samples were also obtained from the excavations.

The exploratory borings were excavated using a CME 850 track carrier-mounted drill rig using 8-inch hollow-stem augers. Sampling was accomplished using an automatic 140-pound hammer with a 30-inch drop. Samples were obtained with a three-inch outside diameter, split spoon sampler (California Modified Sampler). The number of blows required to drive the California Modified sampler the last 12 inches of the 18-inch sampling interval were recorded on the boring logs. The blow counts presented on the logs have been correlated to equivalent Standard Penetration Test (SPT) blow counts. Upon completion, the borings were backfilled with grout in accordance with Sonoma County standards.

The soil conditions encountered in the trenches and borings were visually examined, classified, and logged in general accordance with the American Society for Testing and Materials (ASTM) Practice for Description and Identification of Soils (Visual - Manual Procedure D2488-90). The logs of the exploratory trenches are presented in Appendix A, Figures A1 through A13. The logs of the exploratory borings are presented in Appendix A, Figures A14 through A26.

The CPT soundings were performed with a 20-ton CPT rig. The piezocone was advanced at a constant rate of 2 cm/sec. Measurements of tip resistance, sleeve friction and pore water pressure were obtained at 5-cm intervals. Soil behavior types were determined based on accepted correlations developed by Robertson and Campanella, 1988. Electronic logs of the CPT soundings are included herein.

# TP1

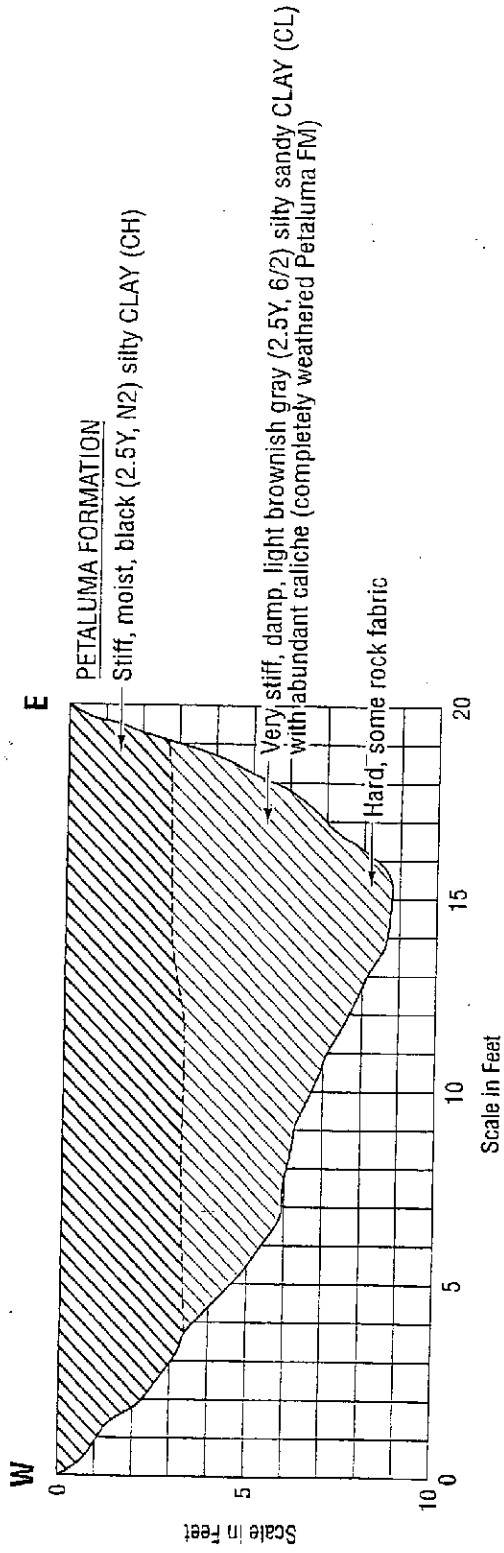

DRAFT



11375 SUNRISE PARK DR. - SUITE 100 - RANCHO CORDOVA, CA. 95742  
PHONE 916 852-9118 - FAX 916 852-9132

Sonoma Casino  
Sonoma County,  
California

## TRENCH LOG TP1

S8689-06-01

June 2003

Figure A1



# TP2

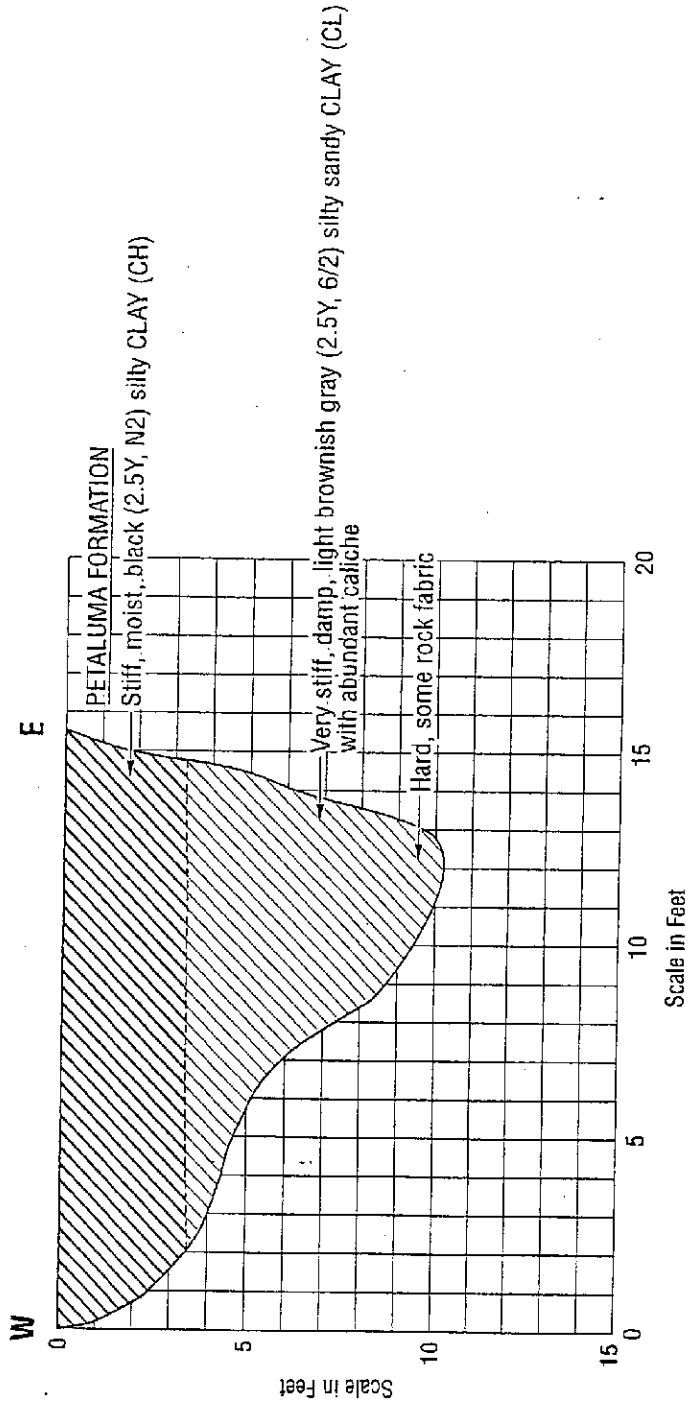

DRAFT

 <b>GEOCON</b> CONSULTANTS, INC. 11375 SUNRISE PARK DR. - SUITE 100 - RANCHO CORDOVA, CA. 95742 PHONE 916 852-9118 - FAX 916 852-9132	
Sonoma Casino Sonoma County, California	
<b>TRENCH LOG TP2</b>	
S8689-06-01	June 2003
Figure A2	

# TP3

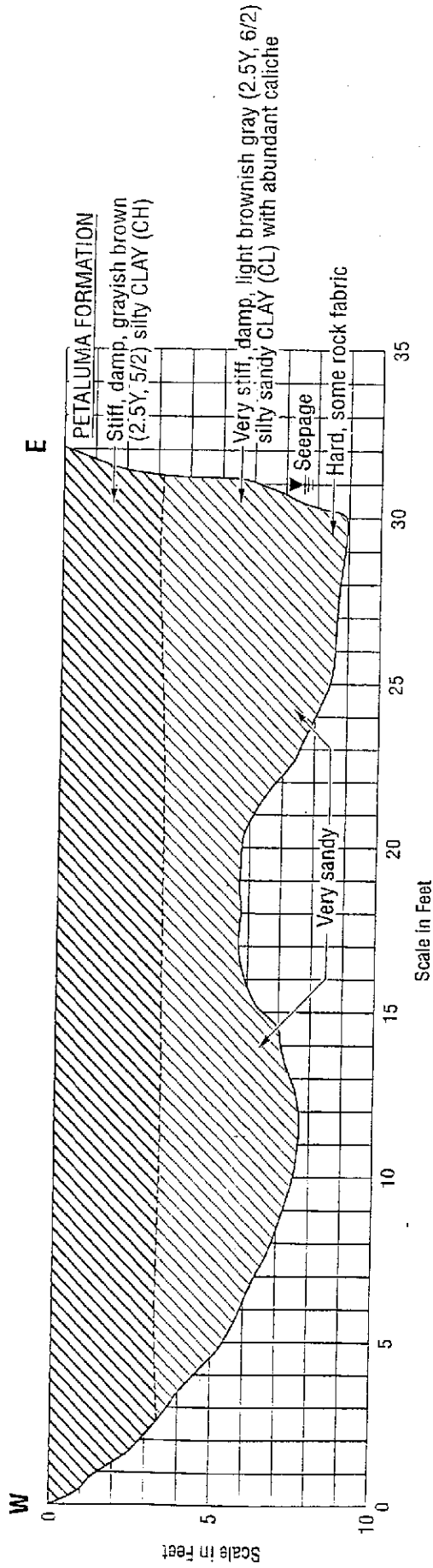

**GEOCON**  
CONSULTANTS, INC.

11375 SUNRISE PARK DR. - SUITE 100 - RANCHO CORDOVA, CA. 95742  
PHONE 916 852-9119 - FAX 916 852-9132



Sonoma Casino

Sonoma County,  
California

## TRENCH LOG TP3

S8689-06-01

June 2003

Figure A3

# TP4

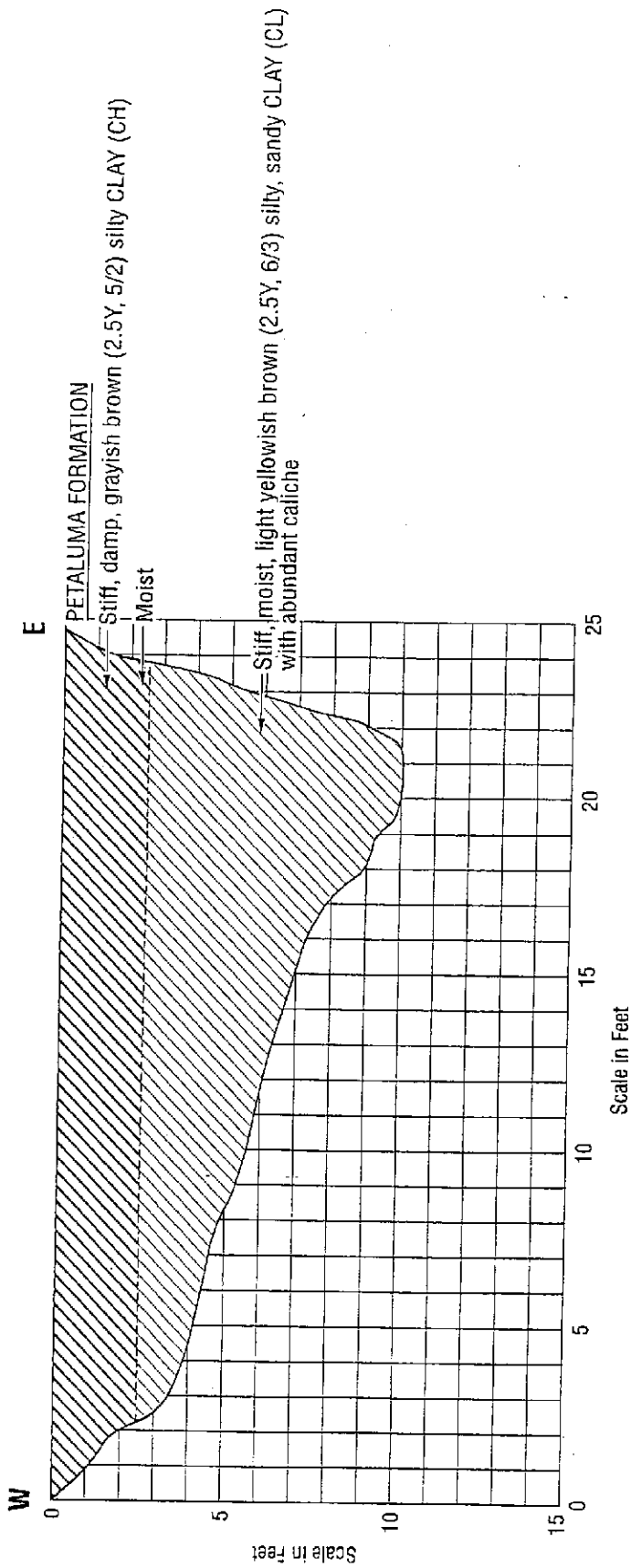

DRAFT

**GEOCON**  
CONSULTANTS, INC.

11375 SUNRISE PARK DR. - SUITE 100 - RANCHO CORDOVA, CA. 95742  
PHONE 916 852-9118 - FAX 916 852-9132



Sonoma Casino  
Sonoma County,  
California

**TRENCH LOG TP4**

S8689-06-01      June 2003      Figure A4

# TP5

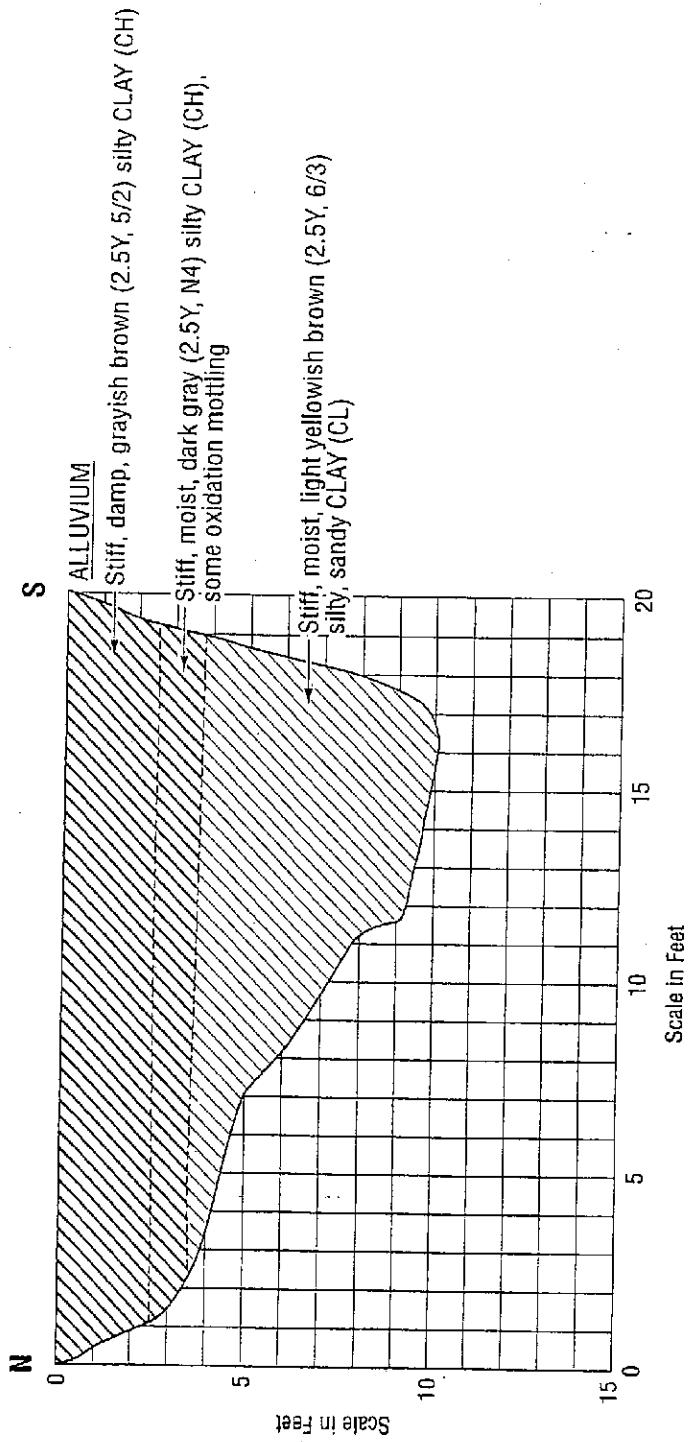

**GEOCON**

CONSULTANTS, INC.

11375 SUNRISE PARK DR. - SUITE 100 - RANCHO CORDOVA, CA. 95742  
 PHONE 916 852-5118 - FAX 916 852-9132



Sonoma Casino

Sonoma County,  
 California

**TRENCH LOG TP5**

S8689-06-01



June 2003

Figure A5

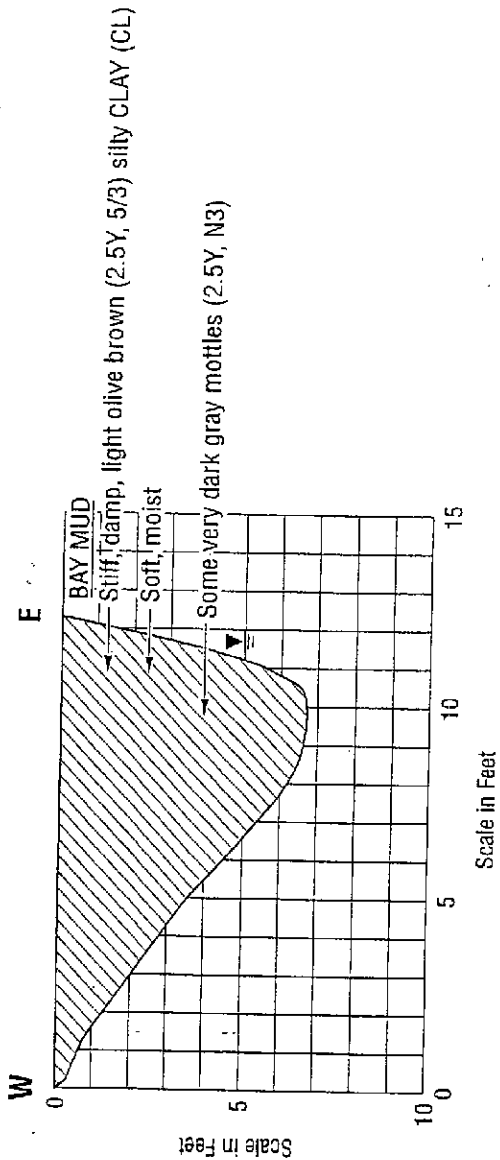
# TP6



DRAFT

 <p>11375 SUNRISE PARK DR. - SUITE 100 - RANCHO CORDOVA, CA. 95742          PHONE 916 852-9118 - FAX 916 852-9132</p>			
		Sonoma Casino	
		Sonoma County, California	
		<b>TRENCH LOG TP6</b>	
S8689-06-01	June 2003	Figure A6	

# TP7

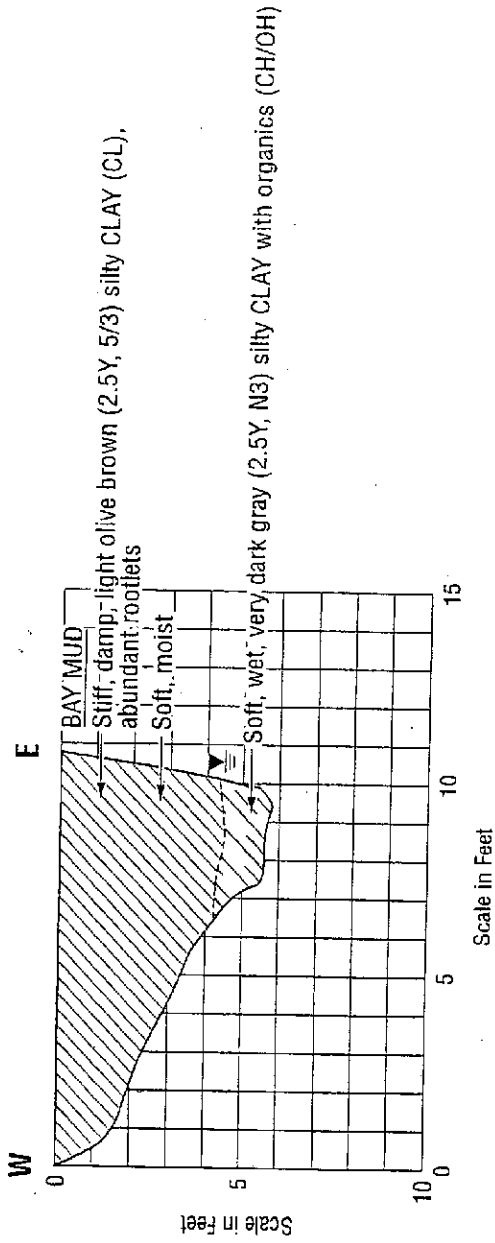

0 5 10 15

**GEOCON**  
CONSULTANTS, INC.

11375 SUNRISE PARK DR. - SUITE 100 - RANCHO CORDOVA, CA. 95742  
PHONE 916 852-9118 - FAX 916 852-9132



Sonoma Casino

Sonoma County,  
California

## TRENCH LOG TP7

S8689-06-01

June 2003

Figure A7

# TP8

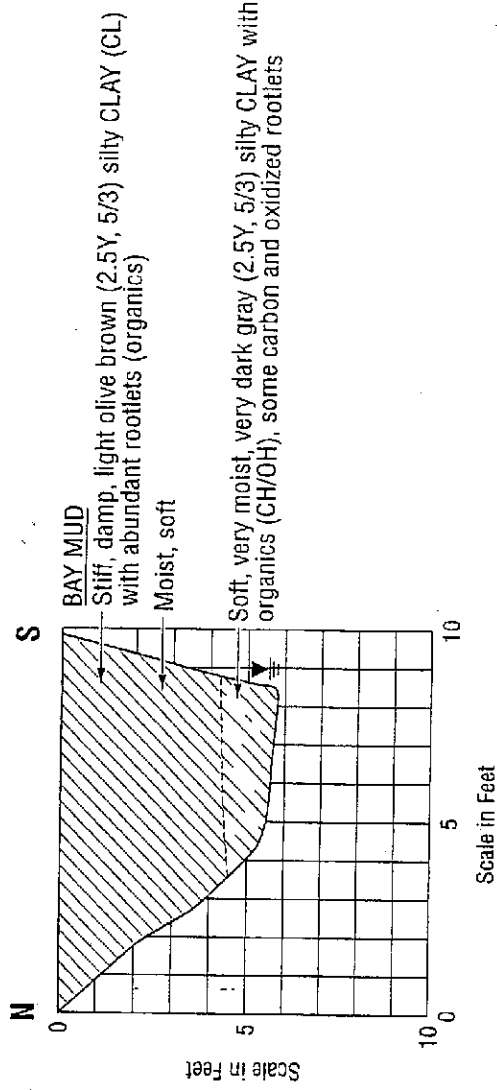

**GEOCON**  
CONSULTANTS, INC.

11375 SUNRISE PARK DR. - SUITE 100 - RANCHO CORDOVA, CA. 95742  
PHONE 916 852-9118 - FAX 916 852-9132



Sonoma Casino  
Sonoma County,  
California

**TRENCH LOG TP8**

S8689-06-01

June 2003

Figure A8

# TP9

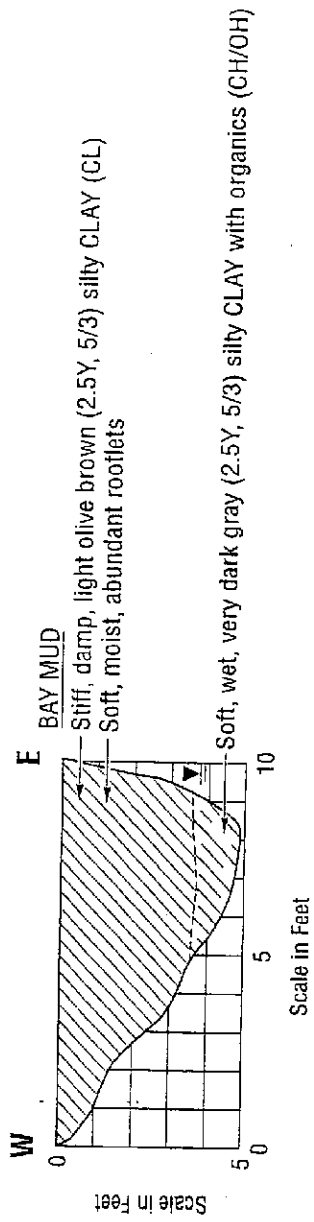

11375 SUNRISE PARK DR. - SUITE 100 - RANCHO CORDOVA, CA. 95742  
PHONE 916 852-9118 - FAX 916 852-9132



11375 SUNRISE PARK DR. - SUITE 100 - RANCHO CORDOVA, CA. 95742  
PHONE 916 852-9118 - FAX 916 852-9132

Sonoma Casino  
Sonoma County,  
California

## TRENCH LOG TP9

S8689-06-01

June 2003

Figure A9



# TP10

## ALLUVIUM

Stiff, damp, grayish brown (2.5Y, 5/2) silty CLAY (CL)

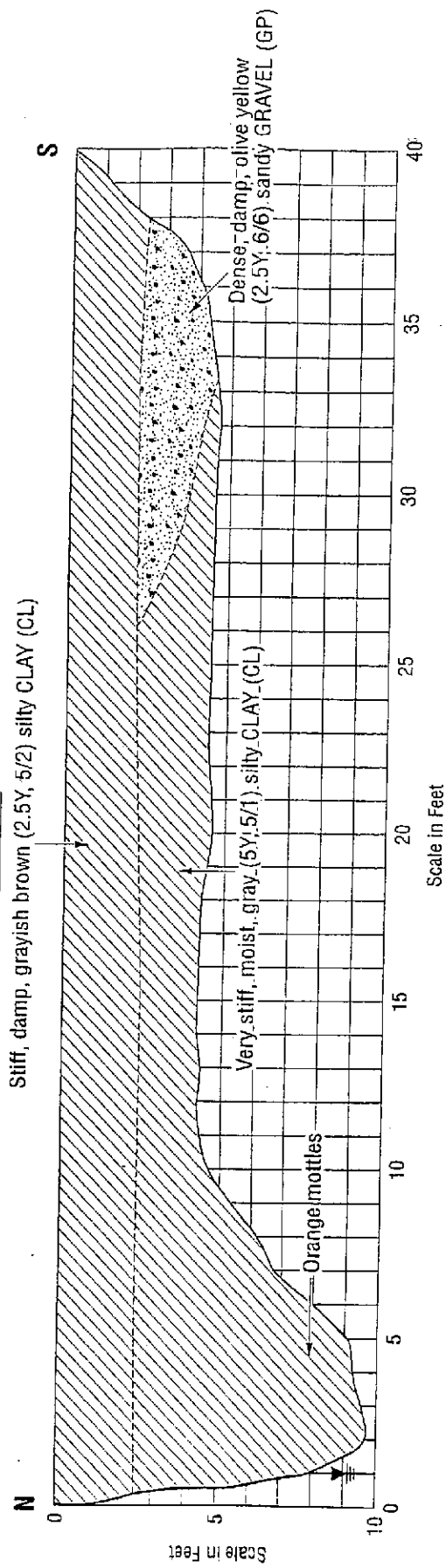

0 5 10 15 20 25 30 35 40

Scale in Feet

**GEOCON**  
CONSULTANTS, INC.  
11375 SUNRISE PARK DR. - SUITE 100 - RANCHO CORDOVA, CA. 95742  
PHONE 916 852-9118 - FAX 916 852-9132

Sonoma Casino  
Sonoma County,  
California

### TRENCH LOG TP10

S8689-06-01

June 2003

Figure A10

# TP11

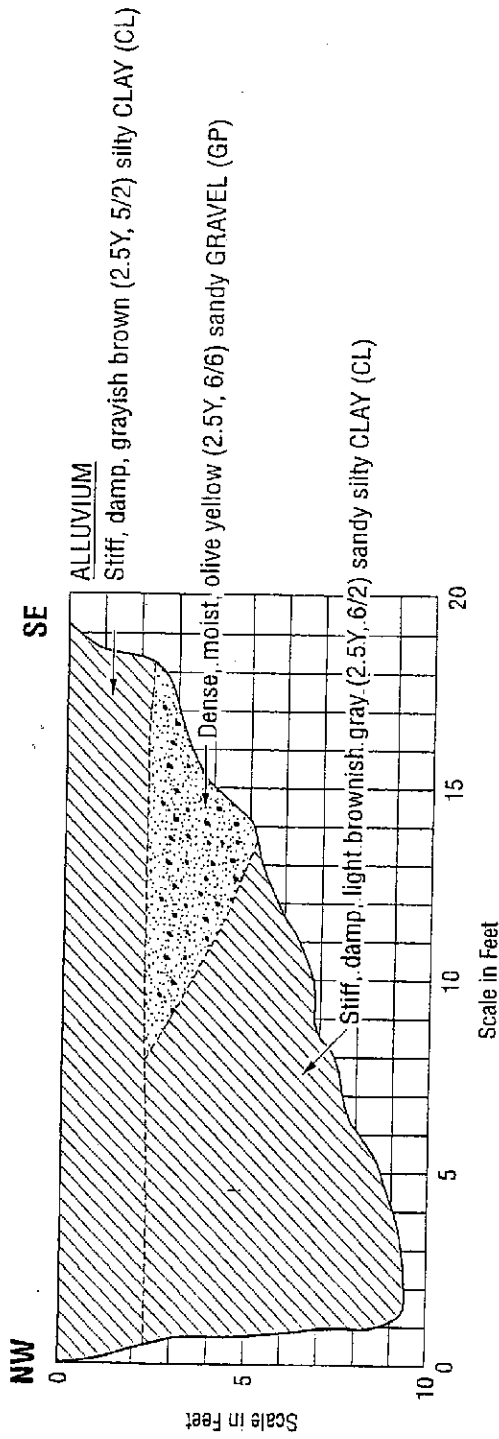

DEPT

**GEOCON**  
CONSULTANTS, INC.

11375 SUNRISE PARK DR. - SUITE 100 - RANCHO CORDOVA, CA. 95742  
PHONE 916 852-9118 - FAX 916 852-9132



Sonoma Casino

Sonoma County,  
California

## TRENCH LOG TP11

S8689-06-01

June 2003

Figure A11

# TP12

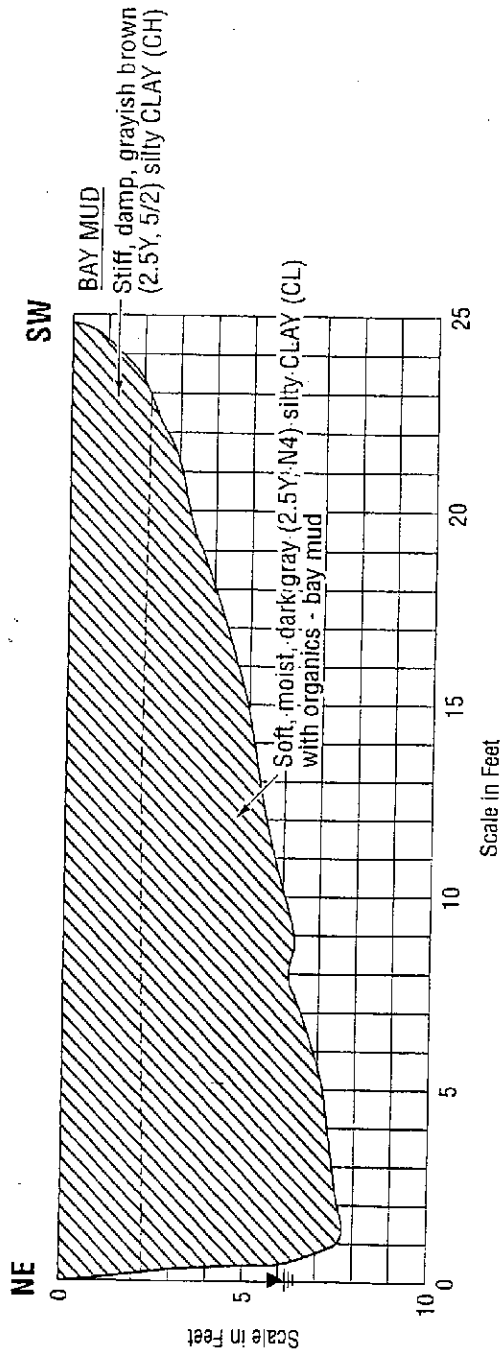

11375 SUNRISE PARK DR. - SUITE 100 - RANCHO CORDOVA, CA. 95742  
PHONE 916 852-9118 - FAX 916 852-9132

Sonoma Casino  
Sonoma County,  
California

## TRENCH LOG TP12

S8689-06-01

June 2003

Figure A12

# TP13

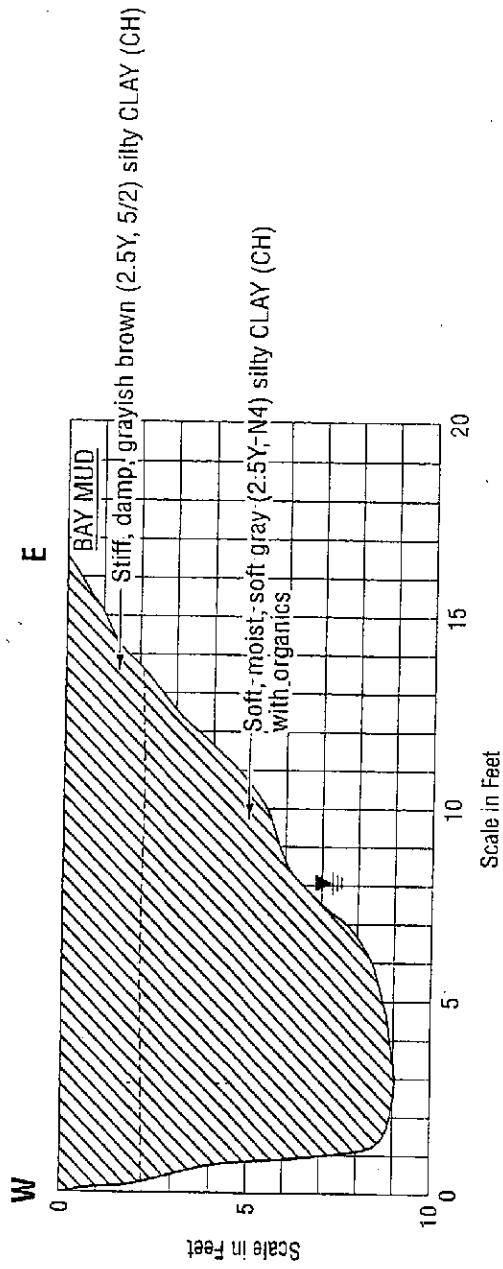

**GEOCON**  
CONSULTANTS, INC.

11875 SUNRISE PARK DR. - SUITE 100 - RANCHO CORDOVA, CA. 95742  
PHONE 916 852-9113 - FAX 916 852-9132



Sonoma Casino  
Sonoma County,  
California

## TRENCH LOG TP13

S8689-06-01









June 2003

Figure A13

DEPTH IN FEET	SAMPLE NO.	LITHOLOGY	GROUNDWATER	BORING B1		PENETRATION RESISTANCE (BLOWS/FT.)	DRY DENSITY (P.C.F.)	MOISTURE CONTENT (%)
				ELEV. (MSL.) ~25	DATE COMPLETED 5/28/03			
				EQUIPMENT CME 850				
MATERIAL DESCRIPTION								
0				CL	<b>ALLUVIUM</b> Stiff, damp, light olive brown (2.5Y 5/3) Silty CLAY pp > 4.5, tv > 1			
2								
4	B1-3					14		
6				GM/GC	Very dense, damp, olive brown (2.5Y 4/3), Clayey, Silty, Sandy GRAVEL, pebble size	40		
8								
10					- very Clayey			
12	B1-11				- trace white non-calcareous mineral, trace shell fragment	28		
14								
16	B1-16				- less clay, very moist	27		
18								
20	B1-20			CL	Very stiff, moist, light olive brown (2.5Y 5/3), Silty CLAY, with some orange mottles pp = 2.7, tv = 0.65	20		
22								
24								
26	B1-25.5 B1-26			SP/SM	Medium dense, wet, olive brown (2.5Y 4/3), Silty SAND	24		

Figure A14, Log of Boring B1, page 1 of 2

GEO\_NO\_WELL SONOMA.GPJ 06/06/03

SAMPLE SYMBOLS		
	... SAMPLING UNSUCCESSFUL	
	... DISTURBED OR BAG SAMPLE	
	... DRIVE SAMPLE (UNDISTURBED)	
	... CHUNK SAMPLE	
		... WATER TABLE OR SEEPAGE

NOTE: THE LOG OF SUBSURFACE CONDITIONS SHOWN HEREON APPLIES ONLY AT THE SPECIFIC BORING OR TRENCH LOCATION AND AT THE DATE INDICATED. IT IS NOT WARRANTED TO BE REPRESENTATIVE OF SUBSURFACE CONDITIONS AT OTHER LOCATIONS AND TIMES. ALL BLOW COUNTS HAVE BEEN CONVERTED TO EQUIVALENT STANDARD PENETRATION TEST (SPT) BLOW COUNTS

PROJECT NO. S8689-06-01

DEPTH IN FEET	SAMPLE NO.	LITHOLOGY	GROUNDWATER	SOIL CLASS (USCS)	BORING B1 <b>DRAFT</b>		PENETRATION RESISTANCE (BLOWS/FT.)	DRY DENSITY (P.C.F.)	MOISTURE CONTENT (%)
					ELEV. (MSL.) ~25	DATE COMPLETED 5/28/03			
					EQUIPMENT CME 850				
MATERIAL DESCRIPTION									
28									
30	B1-30.5 B1-31								
							27		
BORING TERMINATED AT 31.5 FEET									

Figure A15, Log of Boring B1, page 2 of 2

GEO\_NQ\_WELL SONOMA.GPJ 05/06/03

<b>SAMPLE SYMBOLS</b>	<input type="checkbox"/> ... SAMPLING UNSUCCESSFUL	<input type="checkbox"/> ... STANDARD PENETRATION TEST	<input checked="" type="checkbox"/> ... DRIVE SAMPLE (UNDISTURBED)
	<input checked="" type="checkbox"/> ... DISTURBED OR BAG SAMPLE	<input checked="" type="checkbox"/> ... CHUNK SAMPLE	<input checked="" type="checkbox"/> ... WATER TABLE OR SEEPAGE

NOTE: THE LOG OF SUBSURFACE CONDITIONS SHOWN HEREON APPLIES ONLY AT THE SPECIFIC BORING OR TRENCH LOCATION AND AT THE DATE INDICATED. IT IS NOT WARRANTED TO BE REPRESENTATIVE OF SUBSURFACE CONDITIONS AT OTHER LOCATIONS AND TIMES. ALL BLOW COUNTS HAVE BEEN CONVERTED TO EQUIVALENT STANDARD PENETRATION TEST (SPT) BLOW COUNTS

DEPTH IN FEET	SAMPLE NO.	LITHOLOGY	GROUNDWATER	BORING B2		PENETRATION RESISTANCE (BLOWS/FT.)	DRY DENSITY (P.C.F.)	MOISTURE CONTENT (%)
				ELEV. (MSL.) ~80	DATE COMPLETED 5/28/03			
				EQUIPMENT CME 850				
MATERIAL DESCRIPTION								
0				CH	PETALUMA FORMATION			
				CL	Stiff, damp, dark brown, Silty CLAY			
2					Very stiff, damp, light brownish gray (2.5Y 6/2), Sandy Silty CLAY			
					pp = 4.0 tv = 0.77			
6	B2-5.5 B2-6				- very stiff - very sandy	25		
8								
10								
12	B2-11				- hard - oxidation mottles	35		
14								
16	B2-15				- abundant caliche - very stiff	28		
18								
20								
22	B2-21			SM	Dense, wet, dark gray (2.5Y, ) Silty SAND	26		
				CL	Very stiff, moist, grayish brown (2.5Y, 5/2), very Sandy Silty CLAY			
24								
26	B2-25			GC	Dense, wet, dark gray (2.5Y N4), Clayey Silty Sandy GRAVEL	27		
				CL	Very stiff, moist, grayish brown (2.5Y 5/2), Sandy Silty CLAY, abundant caliche, some oxidation mottles			

Figure A16, Log of Boring B2, page 1 of 2

GEO\_NO\_WELL SONOMA.GPJ 06/05/03

SAMPLE SYMBOLS					
<input type="checkbox"/>	... SAMPLING UNSUCCESSFUL	<input type="checkbox"/>	... STANDARD PENETRATION TEST	<input type="checkbox"/>	... DRIVE SAMPLE (UNDISTURBED)
<input type="checkbox"/>	... DISTURBED OR BAG SAMPLE	<input type="checkbox"/>	... CHUNK SAMPLE	<input type="checkbox"/>	... WATER TABLE OR SEEPAGE

NOTE: THE LOG OF SUBSURFACE CONDITIONS SHOWN HEREON APPLIES ONLY AT THE SPECIFIC BORING OR TRENCH LOCATION AND AT THE DATE INDICATED. IT IS NOT WARRANTED TO BE REPRESENTATIVE OF SUBSURFACE CONDITIONS AT OTHER LOCATIONS AND TIMES. ALL BLOW COUNTS HAVE BEEN CONVERTED TO EQUIVALENT STANDARD PENETRATION TEST (SPT) BLOW COUNTS

PROJECT NO. S8689-06-01

DEPTH IN FEET	SAMPLE NO.	LITHOLOGY	GROUNDWATER	BORING B2 <b>DRAFT</b>		PENETRATION RESISTANCE (BLOWS/FT.)	DRY DENSITY (P.C.F.)	MOISTURE CONTENT (%)
				ELEV. (MSL.) ~80	DATE COMPLETED 5/28/03			
				EQUIPMENT CME 850				
				MATERIAL DESCRIPTION				
28		[Hatched pattern]		pp > 4.5 tv > 1				
30								
	B2-31	[Cross-hatched pattern]		- hard		40		
				BORING TERMINATED AT 31.5 FEET				

Figure A17, Log of Boring B2, page 2 of 2

GEO\_NO\_WELL SONOMA.GPJ 06/06/03

SAMPLE SYMBOLS					
<input type="checkbox"/>	... SAMPLING UNSUCCESSFUL	<input type="checkbox"/>	... STANDARD PENETRATION TEST	<input type="checkbox"/>	... DRIVE SAMPLE (UNDISTURBED)
<input checked="" type="checkbox"/>	... DISTURBED OR BAG SAMPLE	<input type="checkbox"/>	... CHUNK SAMPLE	<input type="checkbox"/>	... WATER TABLE OR SEEPAGE

NOTE: THE LOG OF SUBSURFACE CONDITIONS SHOWN HEREON APPLIES ONLY AT THE SPECIFIC BORING OR TRENCH LOCATION AND AT THE DATE INDICATED. IT IS NOT WARRANTED TO BE REPRESENTATIVE OF SUBSURFACE CONDITIONS AT OTHER LOCATIONS AND TIMES. ALL BLOW COUNTS HAVE BEEN CONVERTED TO EQUIVALENT STANDARD PENETRATION TEST (SPT) BLOW COUNTS



DEPTH IN FEET		SAMPLE NO.	LITHOLOGY	GROUNDWATER	SOIL CLASS (USCS)	BORING B3 <b>DRAFT</b>		PENETRATION RESISTANCE (BLOWS/FT.)	DRY DENSITY (P.C.F.)	MOISTURE CONTENT (%)
ELEV. (MSL.) ~25						DATE COMPLETED 5/28/03				
						EQUIPMENT CME 850				
MATERIAL DESCRIPTION										
0					CH	ALLUVIUM Stiff, damp, dark brown, Silty CLAY				
2					GC	Medium dense, damp, olive yellow (2.5Y 6/6), Clayey Silty SANDY GRAVEL				
4		B3-3					22			
6		B3-5				- very sandy and silty, slightly calcareous	32			
10		B3-10			SM	Medium dense, damp, light olive brown (2.5Y 5/4), Silty SAND	22			
14						- very hard drilling				
16		B3-15			GM	Medium dense, moist, olive yellow (2.5Y 6/6), Silty SANDY GRAVEL	23			
20		B3-20			SC/SM	Medium dense, damp, olive yellow (2.5Y 6/6), Gravelly Silty SAND	25			
26		B3-26			CL SM	Very stiff, moist, grayish brown (2.5Y 5/2), Silty CLAY Medium dense, moist, olive yellow (2.5Y 6/6), Gravelly Silty SAND	25			

Figure A18, Log of Boring B3, page 1 of 2

GEO\_NO\_WELL SONOMA.GPJ 06/06/03

SAMPLE SYMBOLS					
	... SAMPLING UNSUCCESSFUL		... STANDARD PENETRATION TEST		... DRIVE SAMPLE (UNDISTURBED)
	... DISTURBED OR BAG SAMPLE		... CHUNK SAMPLE		... WATER TABLE OR SEEPAGE

NOTE: THE LOG OF SUBSURFACE CONDITIONS SHOWN HEREON APPLIES ONLY AT THE SPECIFIC BORING OR TRENCH LOCATION AND AT THE DATE INDICATED. IT IS NOT WARRANTED TO BE REPRESENTATIVE OF SUBSURFACE CONDITIONS AT OTHER LOCATIONS AND TIMES. ALL BLOW COUNTS HAVE BEEN CONVERTED TO EQUIVALENT STANDARD PENETRATION TEST (SPT) BLOW COUNTS

DEPTH IN FEET	SAMPLE NO.	LITHOLOGY	GROUNDWATER	BORING B3 <b>DRAFT</b>		PENETRATION RESISTANCE (BLOWS/FT.)	DRY DENSITY (P.C.F.)	MOISTURE CONTENT (%)
				ELEV. (MSL.) ~25	DATE COMPLETED 5/28/03			
				EQUIPMENT CME 850				
MATERIAL DESCRIPTION								
28								
30	B3-30			CL	Very stiff, damp, dark grayish brown (2.5Y 4/2), Silty CLAY pp = 4.0	28		
BORING TERMINATED AT 31.5 FEET								

Figure A19, Log of Boring B3, page 2 of 2

GEO\_NO\_WELL SONOMA.GPJ 06/06/03

<b>SAMPLE SYMBOLS</b>	<input type="checkbox"/> ... SAMPLING UNSUCCESSFUL	<input type="checkbox"/> ... STANDARD PENETRATION TEST	<input type="checkbox"/> ... DRIVE SAMPLE (UNDISTURBED)
	<input type="checkbox"/> ... DISTURBED OR BAG SAMPLE	<input type="checkbox"/> ... CHUNK SAMPLE	<input type="checkbox"/> ... WATER TABLE OR SEEPAGE

NOTE: THE LOG OF SUBSURFACE CONDITIONS SHOWN HEREON APPLIES ONLY AT THE SPECIFIC BORING OR TRENCH LOCATION AND AT THE DATE INDICATED. IT IS NOT WARRANTED TO BE REPRESENTATIVE OF SUBSURFACE CONDITIONS AT OTHER LOCATIONS AND TIMES. ALL BLOW COUNTS HAVE BEEN CONVERTED TO EQUIVALENT STANDARD PENETRATION TEST (SPT) BLOW COUNTS

DEPTH IN FEET	SAMPLE NO.	LITHOLOGY	GROUNDWATER	SOIL CLASS (USCS)	BORING B4 <b>DRAFT</b>		PENETRATION RESISTANCE (BLOWS/FT.)	DRY DENSITY (P.C.F.)	MOISTURE CONTENT (%)
					ELEV. (MSL.) <u>0</u>	DATE COMPLETED <u>5/29/03</u>			
					EQUIPMENT <u>CME 850</u>				
MATERIAL DESCRIPTION									
0				CH/OH	<b>YOUNGER BAY MUD</b> Stiff, moist, dark gray (5Y 4/1), Silty CLAY tv = 0.55				
2									
4	B4-3				- becomes soft tv = 0.55 pp = 1.5		4		
6	B4-5.5 B4-6				- wet  - becomes very soft, oxidation mottles tv = 4.5 pp = 0.57		3		
8									
10	B4-10.5 B4-11				very dark gray (2.5Y N3) tv = 0.14 pp = 0		0		
12									
14									
16	B4-15 (Shelby)				250 psi to push Shelby tube tv = 0.2 pp = 0 - abundant organics		NA		
18									
20	B4-20 (Shelby)				250 psi to push Shelby tube  tv = 0.15 pp = 0		NA		
22									
24									
26	B4-25.5 B4-26				tv = 0.19 pp = 0		2		

Figure A20, Log of Boring B4, page 1 of 3

GEO\_NO\_WELL SONOMA.GPJ 06/06/03

SAMPLE SYMBOLS		
<input type="checkbox"/>	... SAMPLING UNSUCCESSFUL	<input type="checkbox"/>
<input type="checkbox"/>	... DISTURBED OR BAG SAMPLE	<input type="checkbox"/>
<input type="checkbox"/>	... STANDARD PENETRATION TEST	<input type="checkbox"/>
<input type="checkbox"/>	... CHUNK SAMPLE	<input type="checkbox"/>
<input type="checkbox"/>	... DRIVE SAMPLE (UNDISTURBED)	<input type="checkbox"/>
<input type="checkbox"/>	... WATER TABLE OR SEEPAGE	

NOTE: THE LOG OF SUBSURFACE CONDITIONS SHOWN HEREON APPLIES ONLY AT THE SPECIFIC BORING OR TRENCH LOCATION AND AT THE DATE INDICATED. IT IS NOT WARRANTED TO BE REPRESENTATIVE OF SUBSURFACE CONDITIONS AT OTHER LOCATIONS AND TIMES. ALL BLOW COUNTS HAVE BEEN CONVERTED TO EQUIVALENT STANDARD PENETRATION TEST (SPT) BLOW COUNTS

DEPTH IN FEET	SAMPLE NO.	LITHOLOGY	GROUNDWATER	SOIL CLASS (USCS)	BORING B4		PENETRATION RESISTANCE (BLOWS/FT.)	DRY DENSITY (P.C.F.)	MOISTURE CONTENT (%)
					ELEV. (MSL.)	DATE COMPLETED			
					0	5/29/03			
						CME 850			
MATERIAL DESCRIPTION									
28									
30									
32	B4-31				olive gray (5Y 4/2) tv = 0.2 pp = 0		0		
34									
36	B4-35.5 B4-36				- wood and shell fragments		2		
38									
40									
42	B4-41				tv = 0.03 pp = 0		10		
44									
46							1		
48				SM	- stiffer drilling <b>ALLUVIUM</b> Dense, wet, olive gray (5Y 4/2), Silty SAND				
50									
52	B4-50.5 B4-51			GM	Dense, wet, olive gray (5Y 4/2), Silty Sandy GRAVEL		50		

Figure A21, Log of Boring B4, page 2 of 3

GEO\_NO\_WELL SONOMA.GPJ 06/06/03

SAMPLE SYMBOLS		
<input type="checkbox"/>	... SAMPLING UNSUCCESSFUL	<input type="checkbox"/>
<input type="checkbox"/>	... STANDARD PENETRATION TEST	<input type="checkbox"/>
<input type="checkbox"/>	... DRIVE SAMPLE (UNDISTURBED)	<input type="checkbox"/>
<input type="checkbox"/>	... DISTURBED OR BAG SAMPLE	<input type="checkbox"/>
<input type="checkbox"/>	... CHUNK SAMPLE	<input type="checkbox"/>
<input type="checkbox"/>	... WATER TABLE OR SEEPAGE	

NOTE: THE LOG OF SUBSURFACE CONDITIONS SHOWN HEREON APPLIES ONLY AT THE SPECIFIC BORING OR TRENCH LOCATION AND AT THE DATE INDICATED. IT IS NOT WARRANTED TO BE REPRESENTATIVE OF SUBSURFACE CONDITIONS AT OTHER LOCATIONS AND TIMES. ALL BLOW COUNTS HAVE BEEN CONVERTED TO EQUIVALENT STANDARD PENETRATION TEST (SPT) BLOW COUNTS

PROJECT NO. S8689-06-01

DEPTH IN FEET	SAMPLE NO.	LITHOLOGY	GROUNDWATER	SOIL CLASS (USCS)	<b>BORING B4</b> <b>DRAFT</b>		PENETRATION RESISTANCE (BLOWS/FT.)	DRY DENSITY (P.C.F.)	MOISTURE CONTENT (%)
					ELEV. (MSL.) <u>0</u>	DATE COMPLETED <u>5/29/03</u>			
					EQUIPMENT <u>CME 850</u>				
MATERIAL DESCRIPTION									
54				SM	Very dense, damp, olive gray (5Y 5/4), Clayey Silty SAND				
56	B4-56						56		
58									
60	B4-60			CL	<b>OLDER BAY MUD</b> Stiff, moist, gray (5Y 5/1), Silty CLAY with oxidation mottles		14		
BORING TERMINATED AT 61.5 FEET									

Figure A22, Log of Boring B4, page 3 of 3

GEO\_NO\_WELL SONOMA.GPJ 06/06/03

SAMPLE SYMBOLS		
	... SAMPLING UNSUCCESSFUL	
	... DISTURBED OR BAG SAMPLE	
	... CHUNK SAMPLE	

NOTE: THE LOG OF SUBSURFACE CONDITIONS SHOWN HEREON APPLIES ONLY AT THE SPECIFIC BORING OR TRENCH LOCATION AND AT THE DATE INDICATED. IT IS NOT WARRANTED TO BE REPRESENTATIVE OF SUBSURFACE CONDITIONS AT OTHER LOCATIONS AND TIMES. ALL BLOW COUNTS HAVE BEEN CONVERTED TO EQUIVALENT STANDARD PENETRATION TEST (SPT) BLOW COUNTS

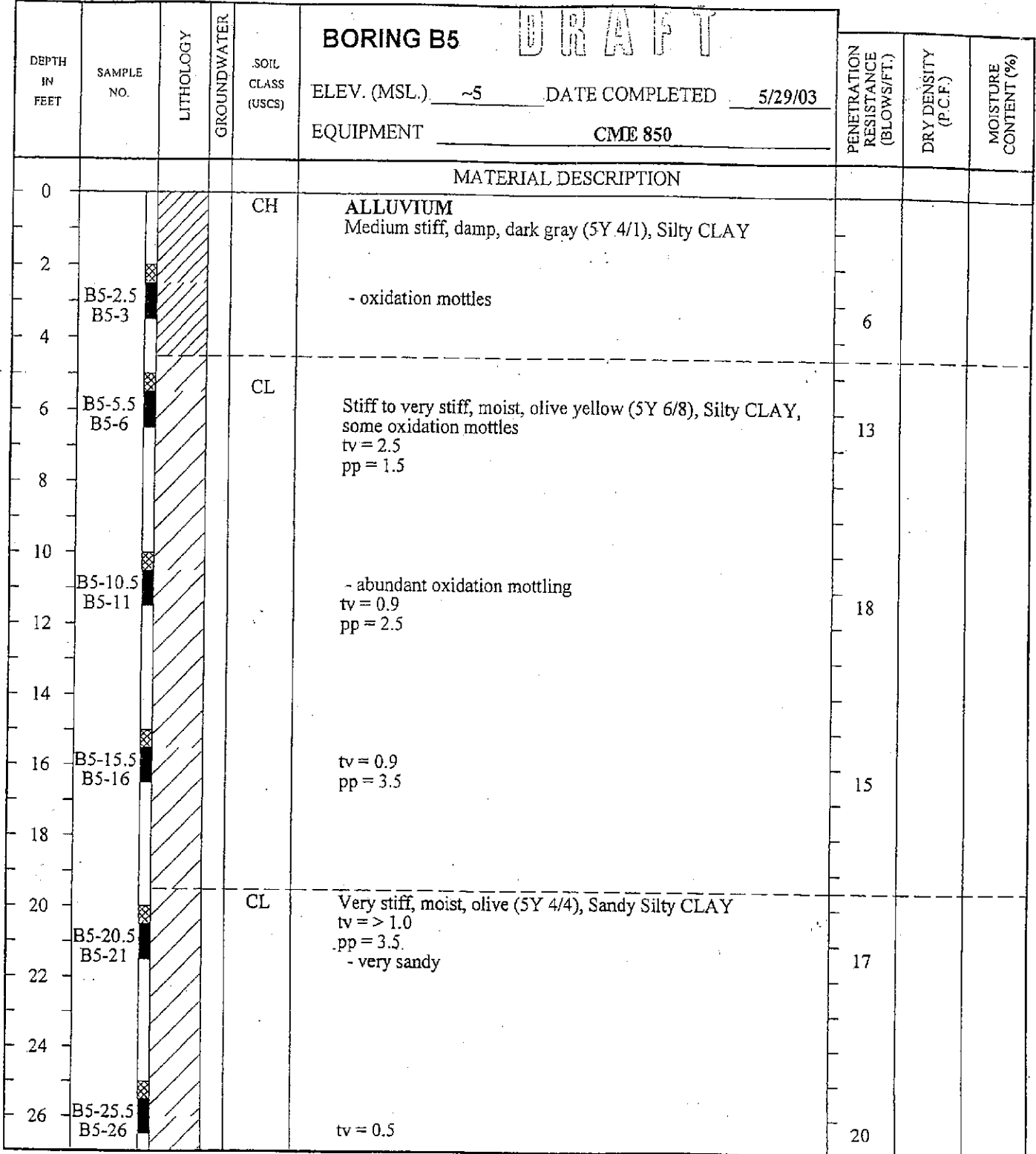

Figure A22, Log of Boring B5, page 1 of 2

GEO\_NO\_WELL SONOMA.GPJ 06/06/03

SAMPLE SYMBOLS					
<input type="checkbox"/>	... SAMPLING UNSUCCESSFUL	<input type="checkbox"/>	... STANDARD PENETRATION TEST	<input type="checkbox"/>	... DRIVE SAMPLE (UNDISTURBED)
<input checked="" type="checkbox"/>	... DISTURBED OR BAG SAMPLE	<input checked="" type="checkbox"/>	... CHUNK SAMPLE	<input checked="" type="checkbox"/>	... WATER TABLE OR SEEPAGE

NOTE: THE LOG OF SUBSURFACE CONDITIONS SHOWN HEREON APPLIES ONLY AT THE SPECIFIC BORING OR TRENCH LOCATION AND AT THE DATE INDICATED. IT IS NOT WARRANTED TO BE REPRESENTATIVE OF SUBSURFACE CONDITIONS AT OTHER LOCATIONS AND TIMES. ALL BLOW COUNTS HAVE BEEN CONVERTED TO EQUIVALENT STANDARD PENETRATION TEST (SPT) BLOW COUNTS

PROJECT NO. S8689-06-01

DEPTH IN FEET	SAMPLE NO.	LITHOLOGY	GROUNDWATER	SOIL CLASS (USCS)	BORING B5 <b>DRAFT</b>		PENETRATION RESISTANCE (BLOWS/FT.)	DRY DENSITY (P.C.F.)	MOISTURE CONTENT (%)
					ELEV. (MSL.) ~5	DATE COMPLETED 5/29/03			
					EQUIPMENT CME 850				
					MATERIAL DESCRIPTION				
28					pp = 2.5				
30	B5-30.5 B5-31				tv > 1.0 pp = 3.5				
					BORING TERMINATED AT 31.5 FEET				
							22		

Figure A23, Log of Boring B5, page 2 of 2

GEO\_NO\_WELL SONOMA.GPJ 06/06/03

SAMPLE SYMBOLS	...		
	<input type="checkbox"/>	SAMPLING UNSUCCESSFUL	<input type="checkbox"/>
<input checked="" type="checkbox"/>	DISTURBED OR BAG SAMPLE	<input checked="" type="checkbox"/>	DRIVE SAMPLE (UNDISTURBED)
<input type="checkbox"/>	CHUNK SAMPLE	<input type="checkbox"/>	WATER TABLE OR SEEPAGE

NOTE: THE LOG OF SUBSURFACE CONDITIONS SHOWN HEREON APPLIES ONLY AT THE SPECIFIC BORING OR TRENCH LOCATION AND AT THE DATE INDICATED. IT IS NOT WARRANTED TO BE REPRESENTATIVE OF SUBSURFACE CONDITIONS AT OTHER LOCATIONS AND TIMES. ALL BLOW COUNTS HAVE BEEN CONVERTED TO EQUIVALENT STANDARD PENETRATION TEST (SPT) BLOW COUNTS

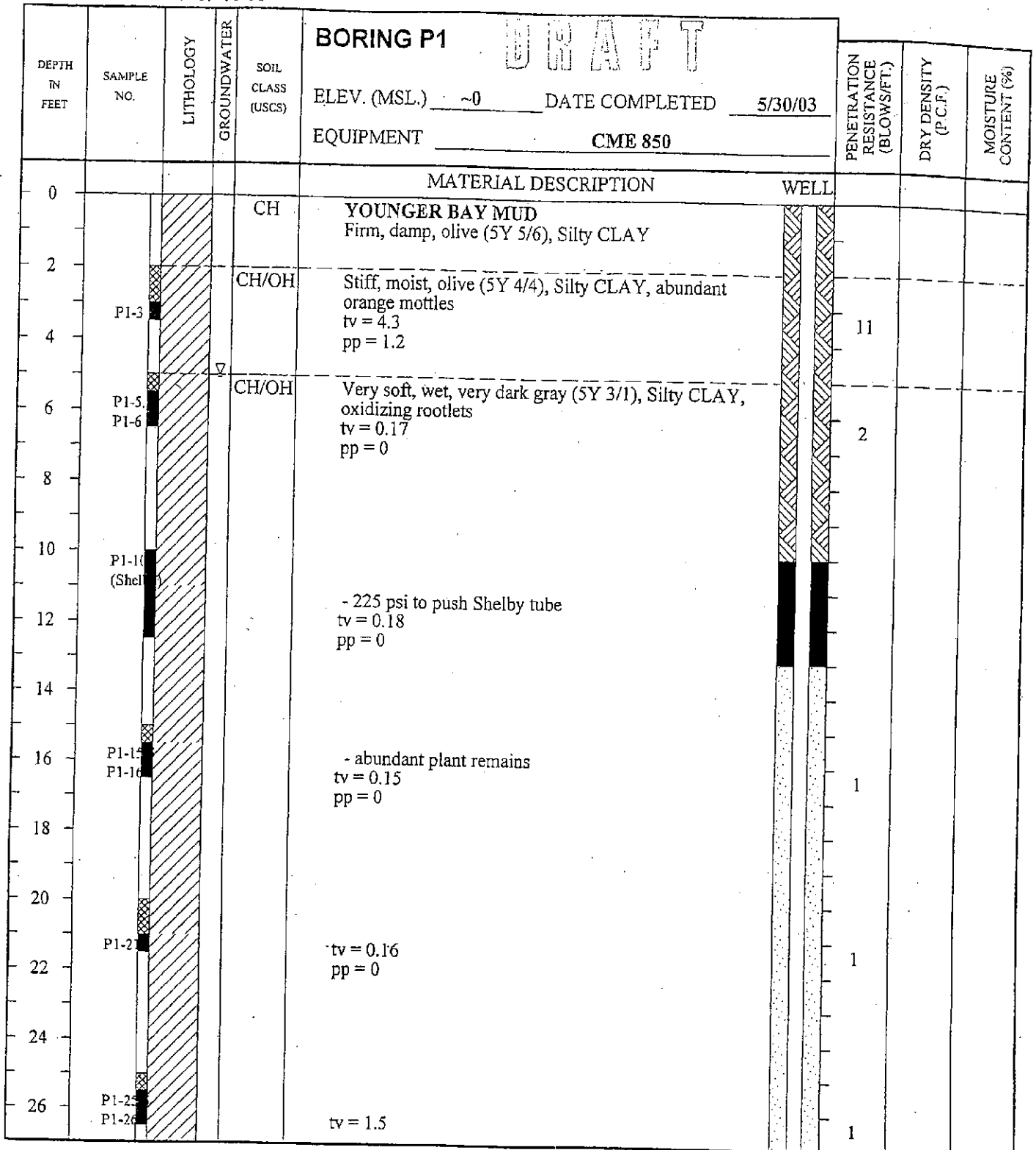

Figure A24, Log of Boring P1, page 1 of 3

GEO\_WELL SONOMA.GPJ 06/06/03

SAMPLE SYMBOLS	
□ ... SAMPLING UNSUCCESSFUL	■ ... STANDARD PENETRATION TEST
⊗ ... DISTURBED OR BAG SAMPLE	■ ... DRIVE SAMPLE (UNDISTURBED)
■ ... CHUNK SAMPLE	▽ ... WATER TABLE OR SEEPAGE

NOTE: THE LOG OF SUBSURFACE CONDITIONS SHOWN HEREON APPLIES ONLY AT THE SPECIFIC BORING OR TRENCH LOCATION AND AT THE DATE INDICATED. IT IS NOT WARRANTED TO BE REPRESENTATIVE OF SUBSURFACE CONDITIONS AT OTHER LOCATIONS AND TIMES. ALL BLOW COUNTS HAVE BEEN CONVERTED TO EQUIVALENT STANDARD PENETRATION TEST (SPT) BLOW COUNTS



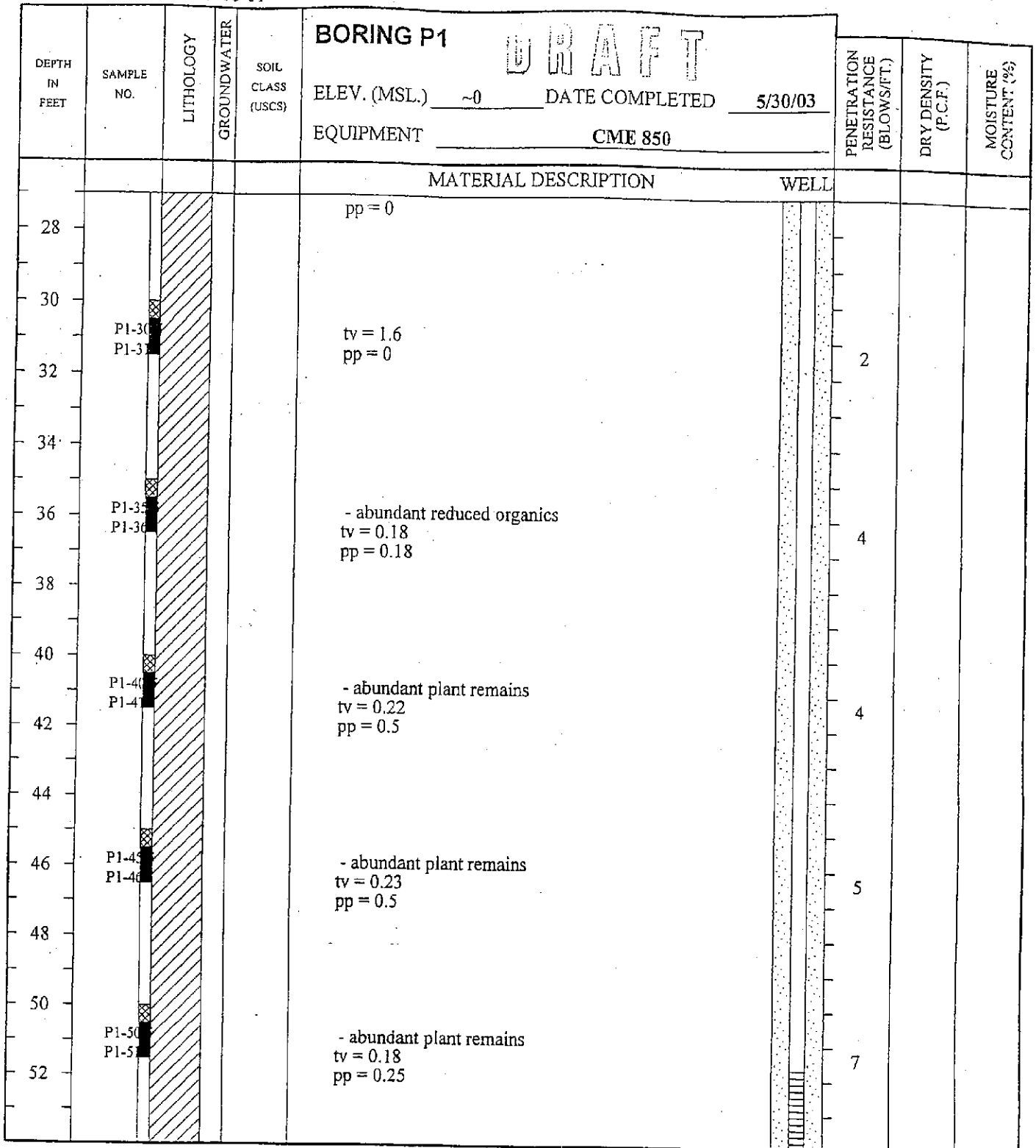

Figure A25, Log of Boring P1, page 2 of 3

GEO\_WELL SONOMA.GPJ 06/06/03

SAMPLE SYMBOLS	
□ ... SAMPLING UNSUCCESSFUL	■ ... STANDARD PENETRATION TEST
⊗ ... DISTURBED OR BAG SAMPLE	■ ... DRIVE SAMPLE (UNDISTURBED)
■ ... CHUNK SAMPLE	▽ ... WATER TABLE OR SEEPAGE

NOTE: THE LOG OF SUBSURFACE CONDITIONS SHOWN HEREON APPLIES ONLY AT THE SPECIFIC BORING OR TRENCH LOCATION AND AT THE DATE INDICATED. IT IS NOT WARRANTED TO BE REPRESENTATIVE OF SUBSURFACE CONDITIONS AT OTHER LOCATIONS AND TIMES. ALL BLOW COUNTS HAVE BEEN CONVERTED TO EQUIVALENT STANDARD PENETRATION TEST (SPT) BLOW COUNTS

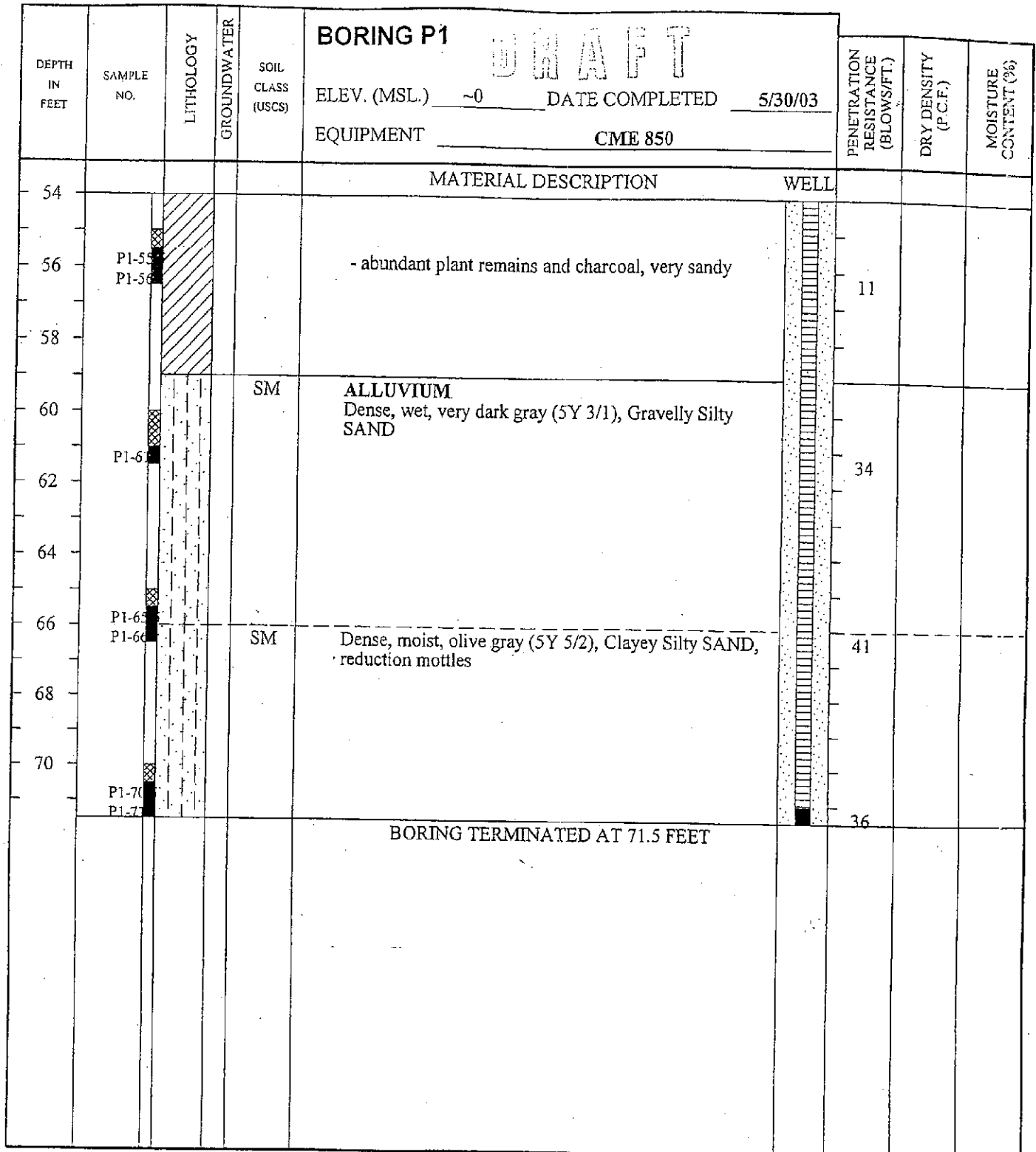







Figure A26, Log of Boring P1, page 3 of 3

GEO\_WELL SONOMA.GPJ 06/06/03

SAMPLE SYMBOLS		
	... SAMPLING UNSUCCESSFUL	
	... DISTURBED OR BAG SAMPLE	
	... CHUNK SAMPLE	
		... WATER TABLE OR SEEPAGE

NOTE: THE LOG OF SUBSURFACE CONDITIONS SHOWN HEREON APPLIES ONLY AT THE SPECIFIC BORING OR TRENCH LOCATION AND AT THE DATE INDICATED. IT IS NOT WARRANTED TO BE REPRESENTATIVE OF SUBSURFACE CONDITIONS AT OTHER LOCATIONS AND TIMES. ALL BLOW COUNTS HAVE BEEN CONVERTED TO EQUIVALENT STANDARD PENETRATION TEST (SPT) BLOW COUNTS



GEOCON

Site : SONOMA  
Location : CPT-1

Engineer : J. ZORNE  
Date : 06:04:03 08:14

Qt (tsf)

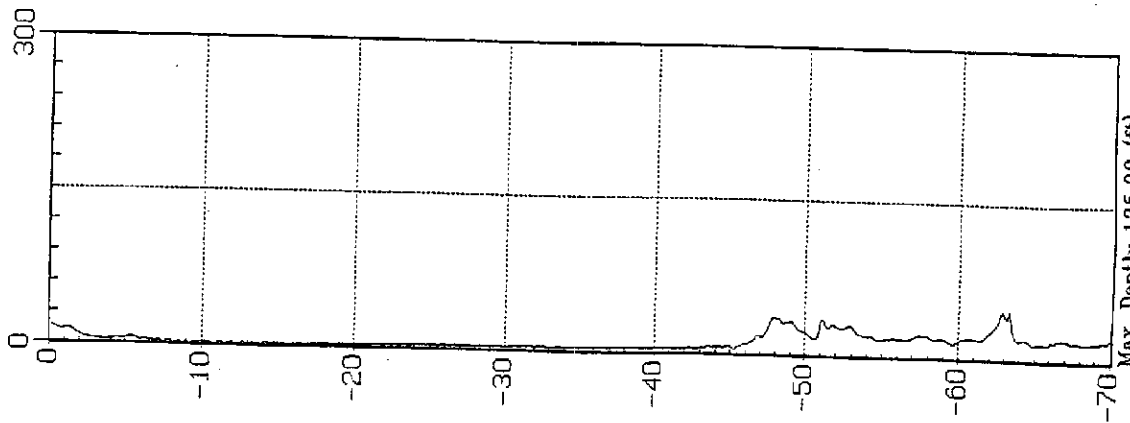

Max Depth: 135.00 (ft)  
Depth Inc.: 0.164 (ft)

Rf (%)

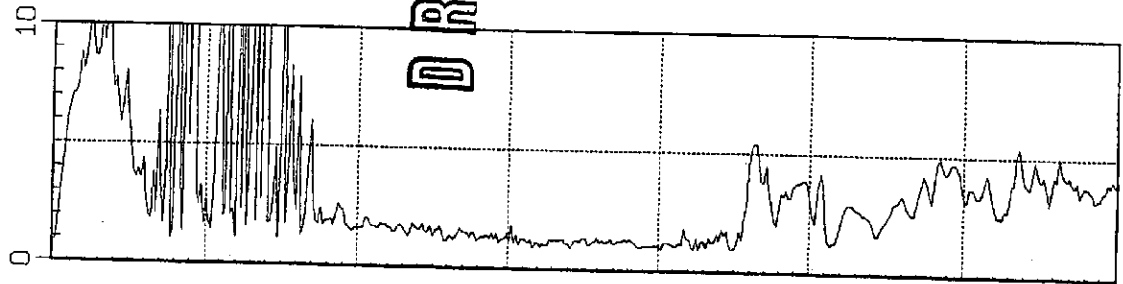

U (psi)

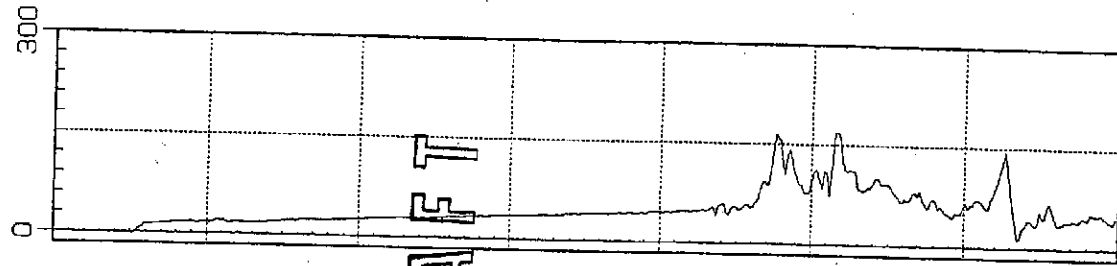

SPT N1(60)

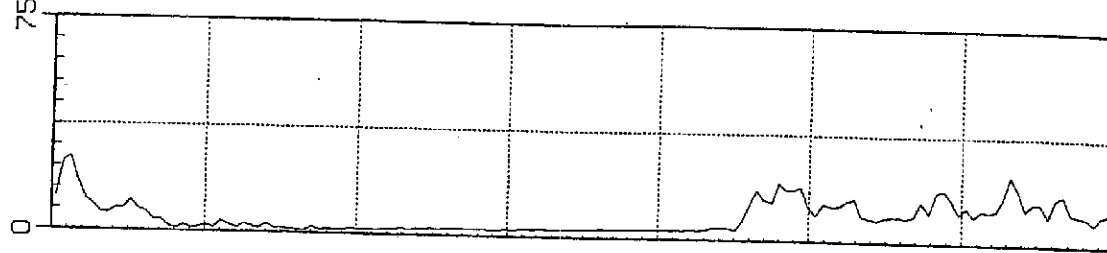

SBT

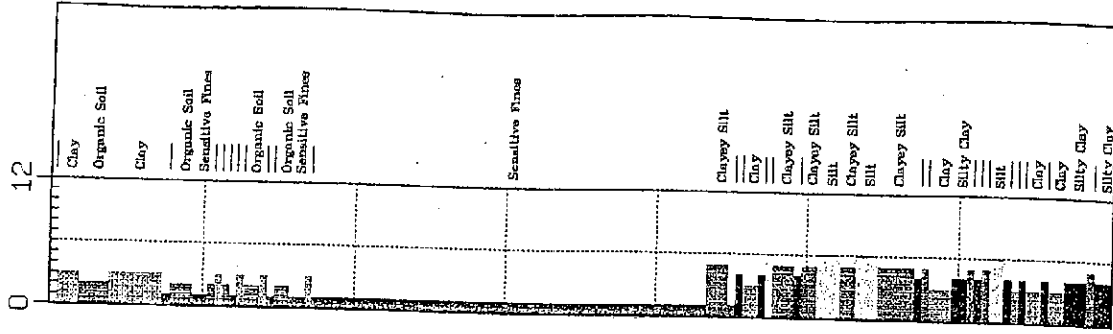

SBT: Soil Behavior Type (Robertson and Campanella 1988)

Depth (ft)

DRAFT





GEOCON

Site : SONOMA  
Location : CPT-2

Engineer : J. ZORNE  
Date : 06:04:03 09:42

Qt (tsf)

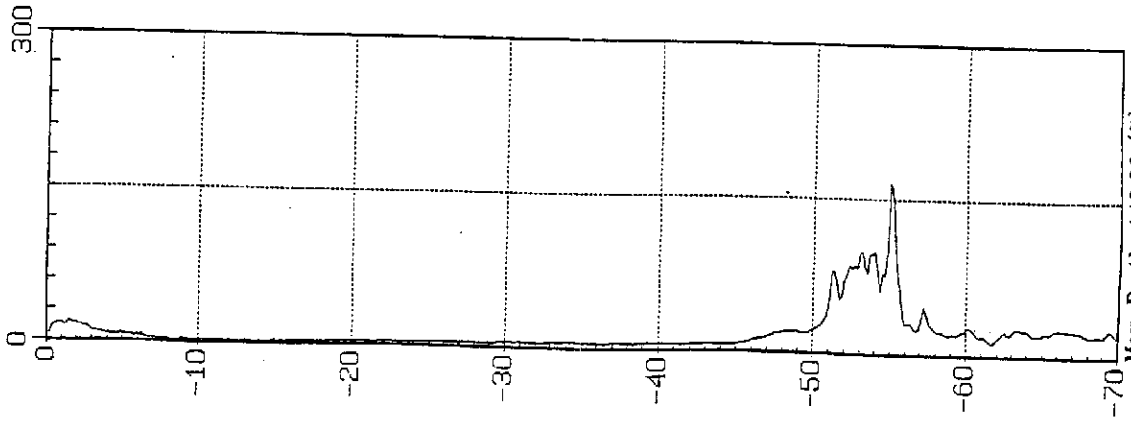

Rf (%)

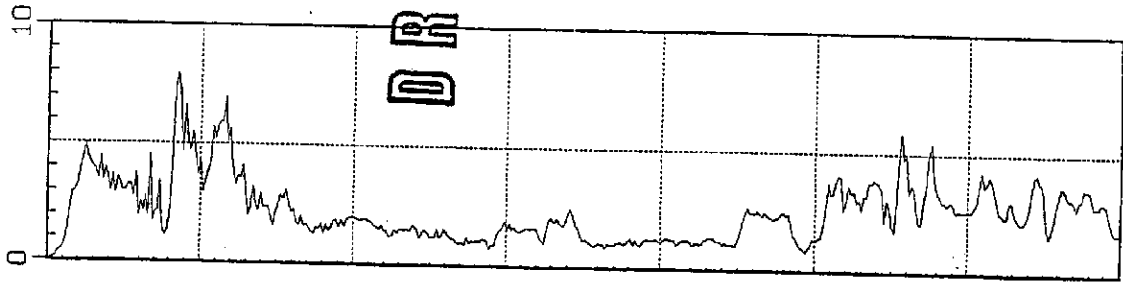

U (psi)

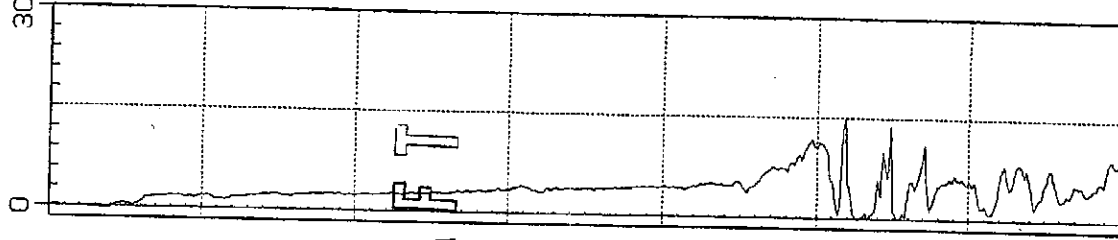

SPT N1(60)

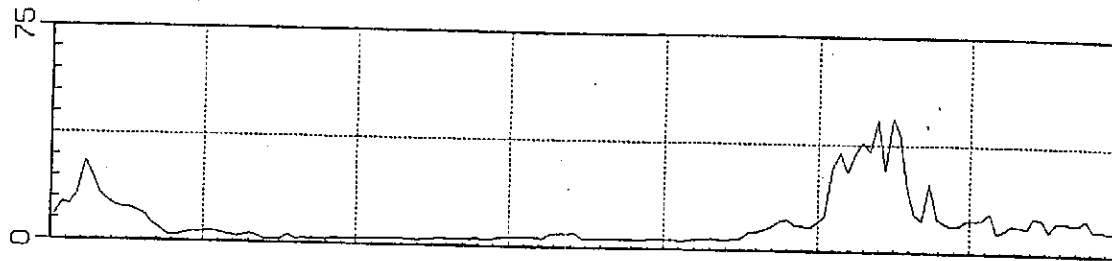

SBT

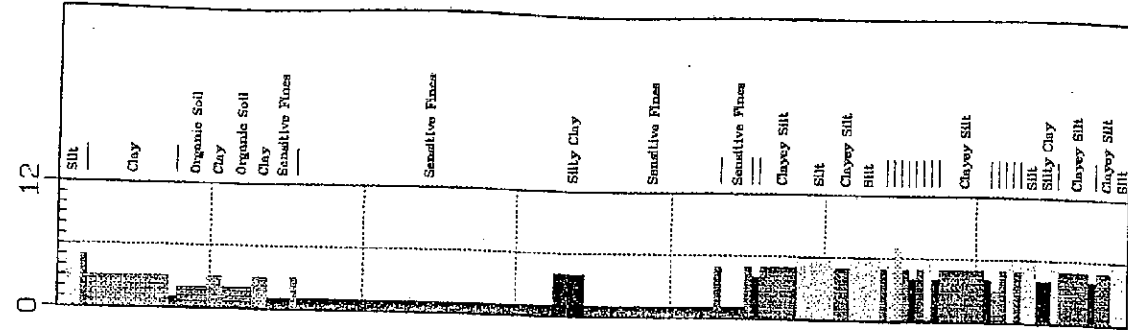

SBT: Soil Behavior Type (Robertson and Campanella 1988)

Depth (ft)

DRAFT



GEOCON

Site : SONOMA  
Location : CPT-2

Engineer : J. ZORNE  
Date : 06:04:03 09:42

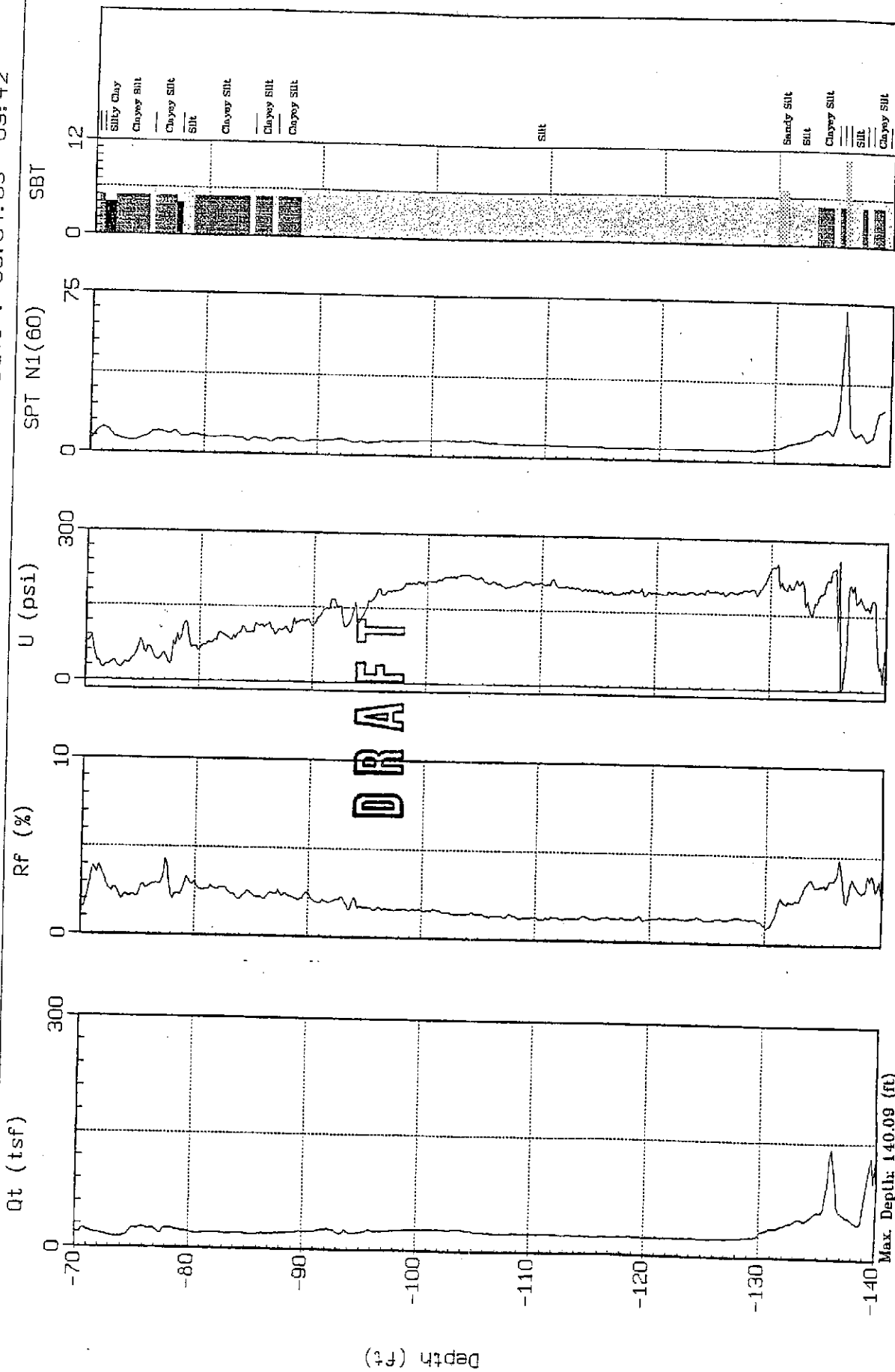

SBT: Soil Behavior Type (Robertson and Campanella 1988)

Max. Depth: 140.09 (ft)  
Depth Inc.: 0.164 (ft)



GEOCON

Site : SONOMA  
Location : CPT-8/3

Engineer : J. ZORNE  
Date : 06:04:03 11:11

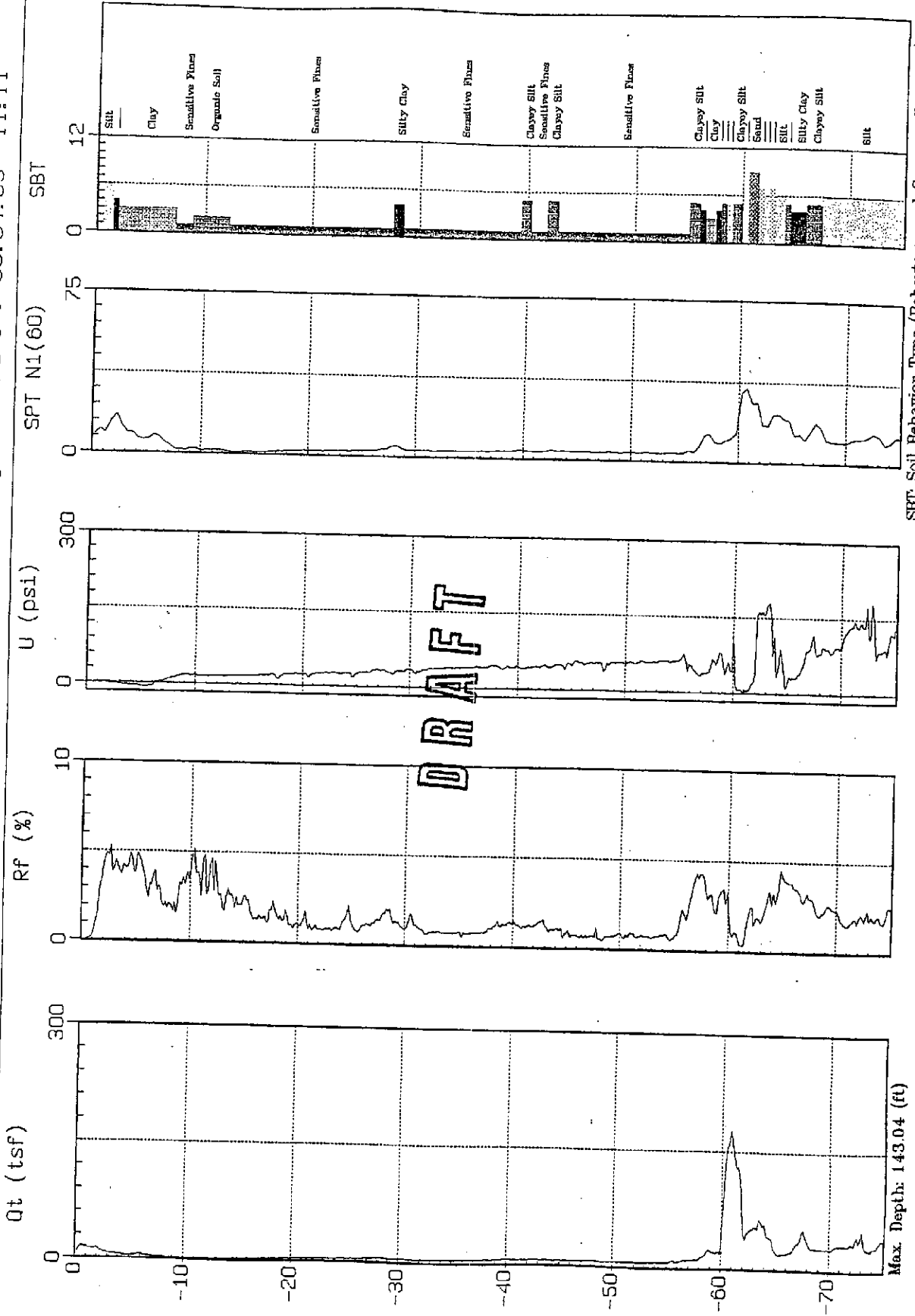

SBT: Soil Behavior Type (Robertson and Campanella 1988)

Max. Depth: 143.04 (ft)  
Depth Inc: 0.164 (ft)

Depth (ft)



GEOCON

Site : SONOMA  
Location : CPT-~~A3~~

Engineer : J. ZORNE  
Date : 06:04:03 11:11

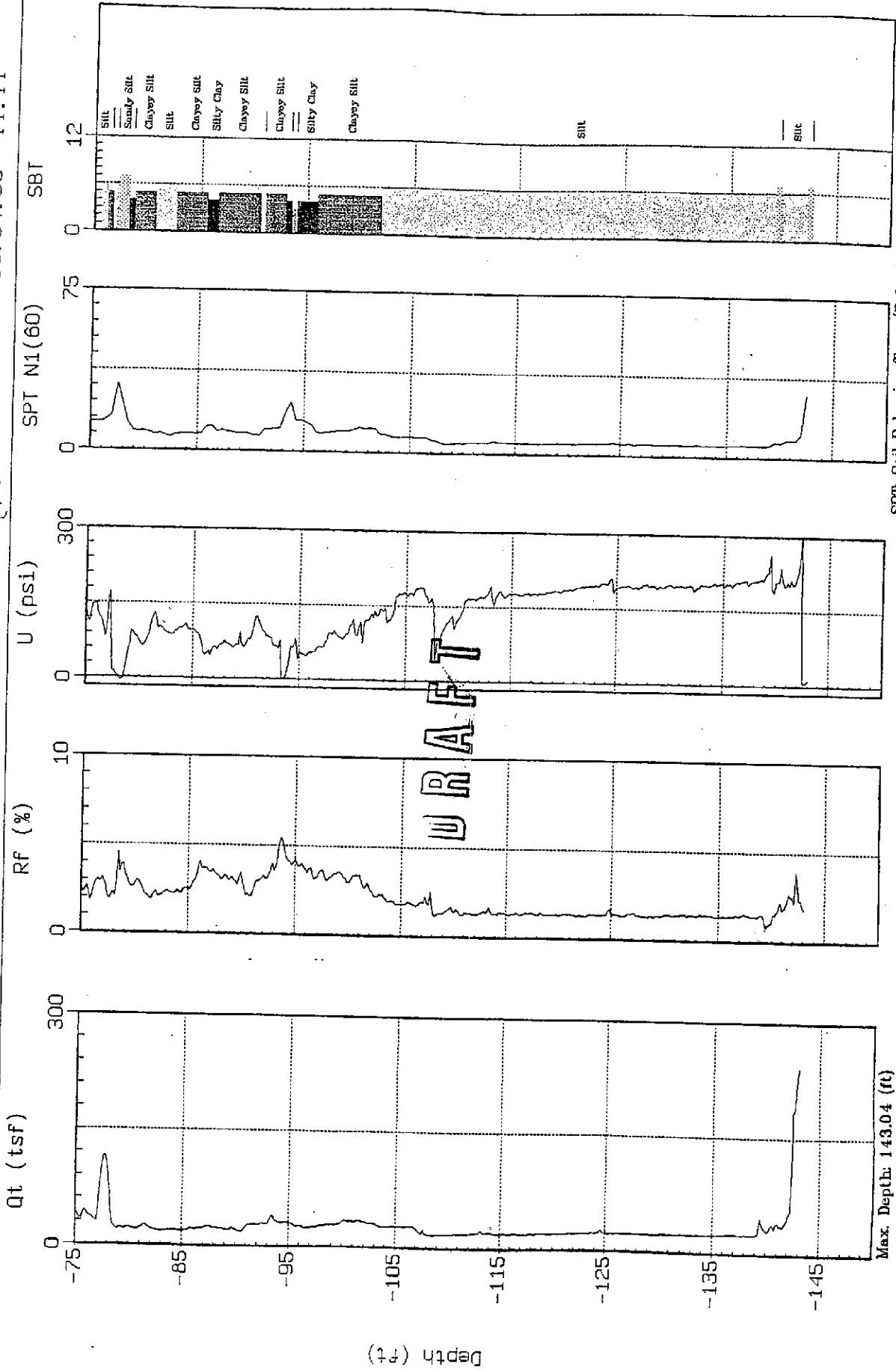

URART

Max. Depth: 143.04 (ft)  
Depth Inc: 0.164 (ft)

SBT: Soil Behavior Type (Robertson and Campanella 1988)





GEOCON

Site : SONOMA  
Location : CPT-4

Engineer : J. ZORNE  
Date : 06:04:03 12:44

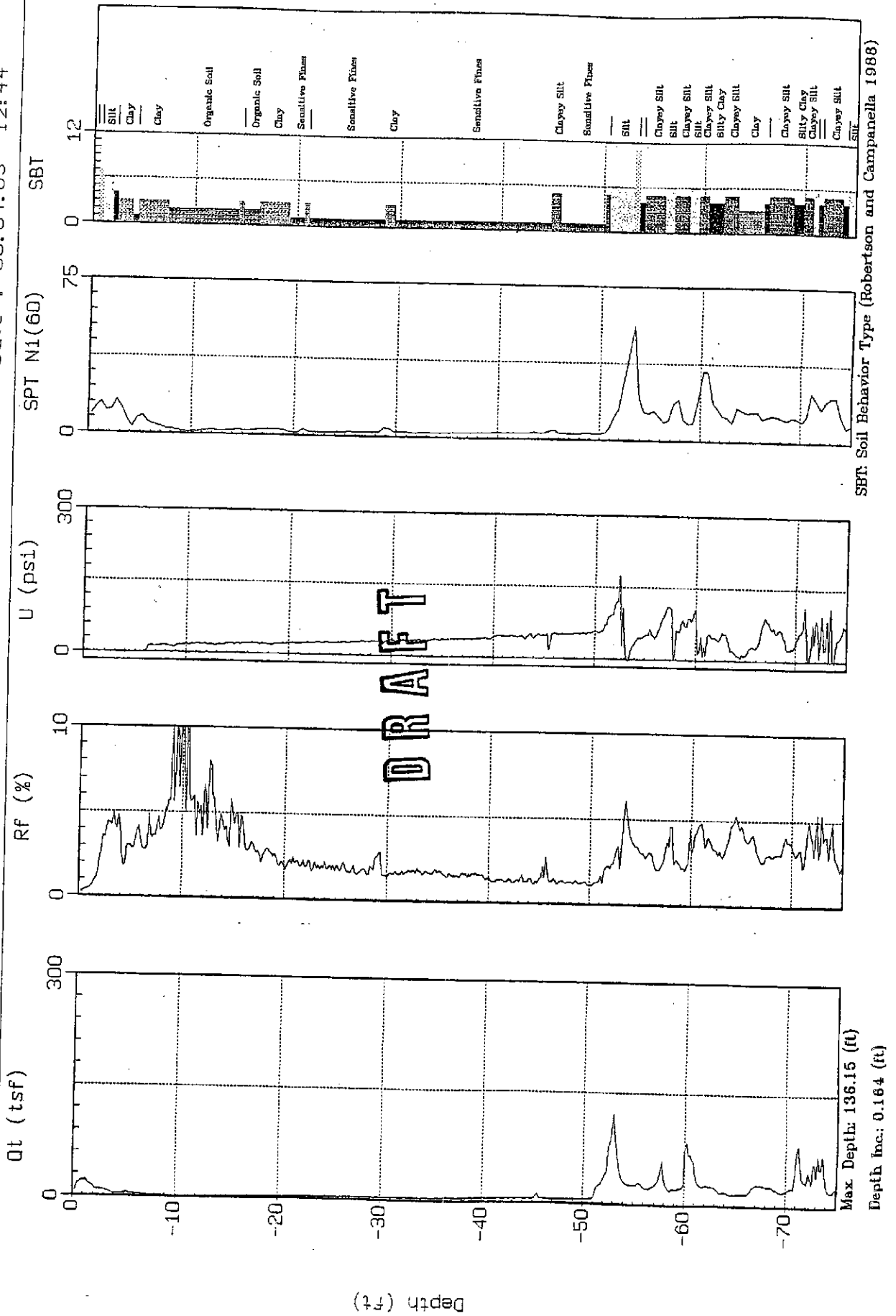

SBT: Soil Behavior Type (Robertson and Campanella 1988)



GEOCON

Site : SONOMA  
Location : CPT-4

Engineer : J. ZORNE  
Date : 06:04:03 12:44

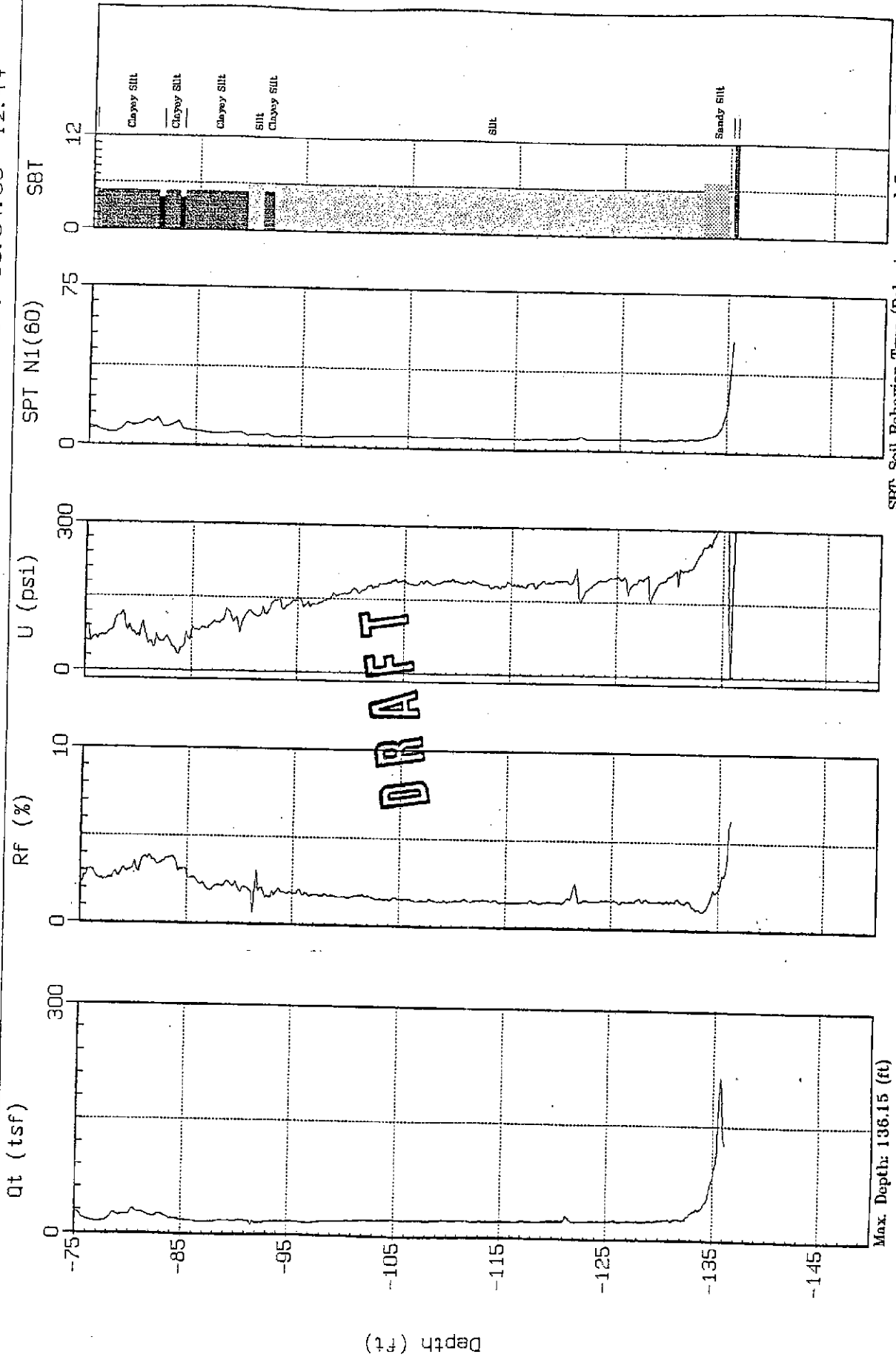

Max. Depth: 136.15 (ft)  
Depth inc: 0.164 (ft)

SBT: Soil Behavior Type (Robertson and Campanella 1988)



GEOCON

Site : SONOMA 5  
Location : CPT-8

Engineer : J. ZORNE  
Date : 06:04:03 14:29

Qt (tsf)

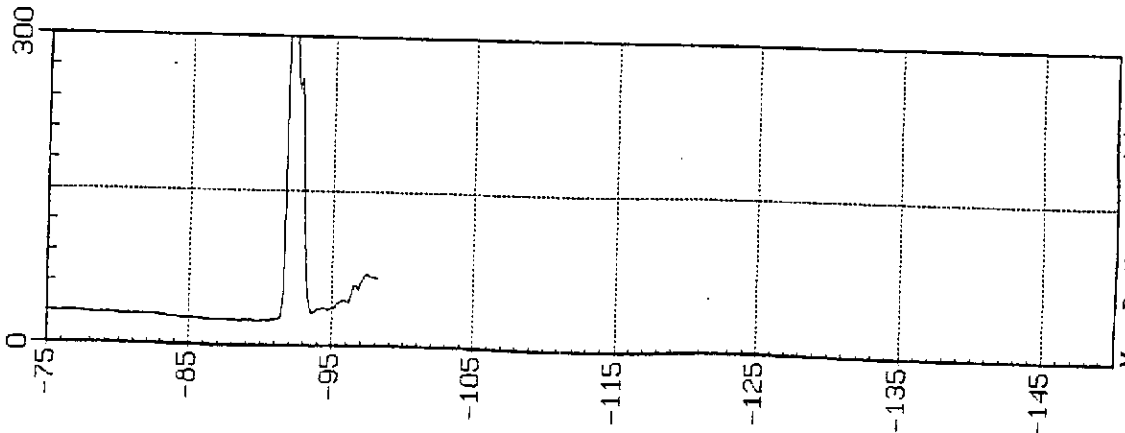

Max Depth: 98.10 (ft)  
Depth Inc.: 0.164 (ft)

Rf (%)

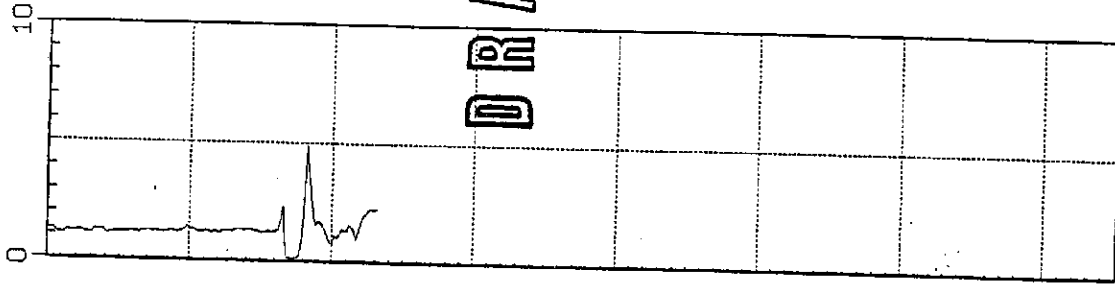

DRAFT

U (psi)

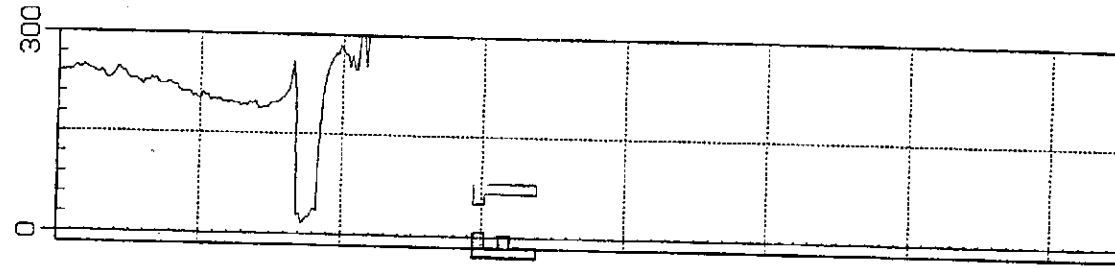

SPT N1(60)

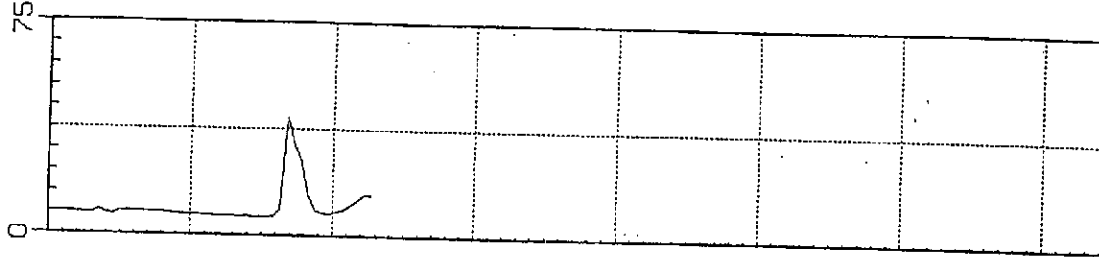

SBT

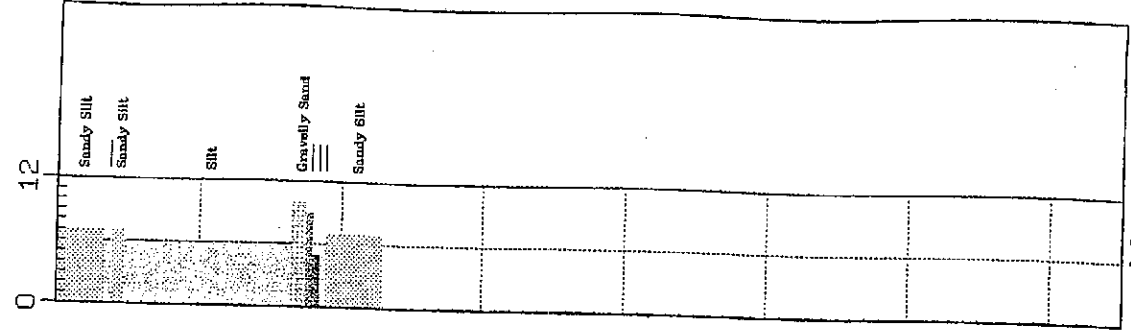

SBT: Soil Behavior Type (Robertson and Campanella 1988)

Depth (ft)



GEOCON

Site : SONOMA  
Location : CPT-~~5~~5

Engineer : J. ZORNE  
Date : 06:04:03 14:29

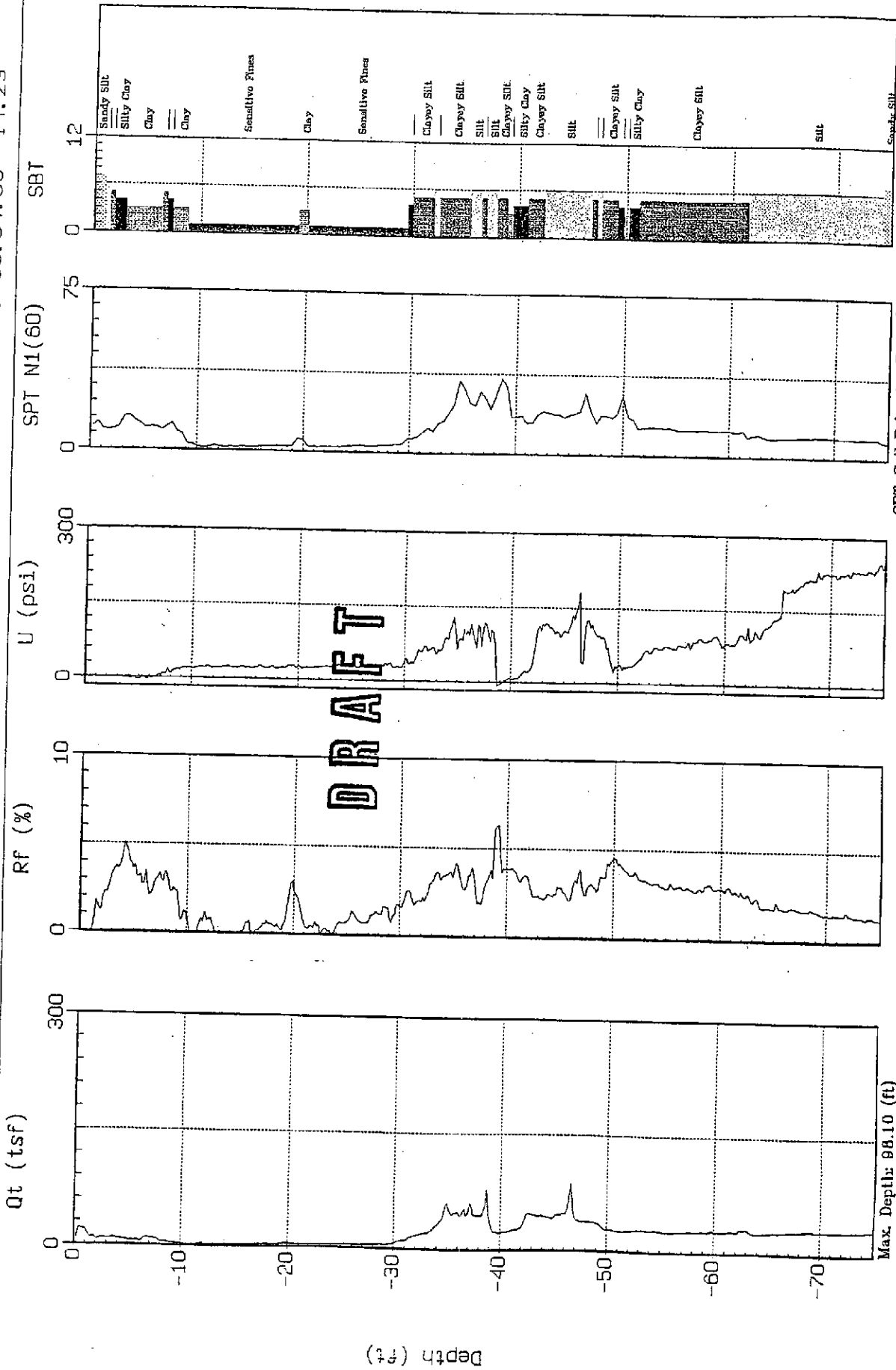

SBT Soil Behavior Type (Robertson and Campanella 1986)

Max. Depth: 88.10 (ft)  
Depth Inc.: 0.164 (ft)

DRAFT

APPENDIX

**B**

## APPENDIX B

### LABORATORY TESTING

Laboratory tests were performed in accordance with generally accepted test methods of the American Society for Testing and Materials (ASTM) procedures. Selected samples were tested for their in-place dry density, moisture content, plasticity index, expansion potential and shear strength parameters. The test results and worksheets are included herein.

GEOCON

MOISTURE / DENSITY TESTS

PROJECT NAME: Sonoma Casino

PROJECT NUMBER: S8689-06-01

DATE: 6-3-03 TESTED BY: PO

LAB NUMBER: 1687

SHEET 1

BORING NO.	TP-1	TP-3	TP-3	TP-5	TP-6	TP-8	TP-9
DEPTH OF SAMPLE (ft)	4	1	3	3	3	4	1
SAMPLE DIAMETER (in.)	2.41	2.4	2.4	2.36	2.4	2.35	2.38
SAMPLE HEIGHT (in.)	5	4.11	5	5	4.5	5	5
TARE NO.	AA-15	B-1	AA-13	AA-12	AA-9	AA-14	AA-8
WET WT.+TARE (gm.)	854	667.3	902.8	838.3	582.8	676.4	596.1
DRY WT.+TARE (gm.)	707.7	620.7	784.6	686.4	352.8	434.2	460.5
TARE WT. (gm.)	110.8	137.9	113	111.9	112.8	111.7	110.3
WT. OF WATER (gm.)	146.3	46.6	118.2	151.9	230.0	242.2	135.6
WT. OF DRY SOIL (gm.)	596.9	482.8	671.6	574.5	240.0	322.5	350.2
WATER CONTENT (%)	24.5%	9.7%	17.6%	26.4%	95.8%	75.1%	38.7%
DRY DENSITY (PCF)	99.7	98.9	113.1	100.1	44.9	56.7	60.0
	<u>Very dark grayish brown to dark yellowish brown FAT CLAY, stiff, moist</u>	<u>Very dark grayish brown to black FAT CLAY, stiff, damp</u>	<u>Light olive brown lean CLAY, with sand, firm, moist</u>	<u>Olive gray sandy lean CLAY, firm, moist</u>	<u>Dark grayish brown organic CLAY, soft, wet</u>	<u>Gray organic CLAY, soft, wet</u>	<u>Very dark grayish brown organic CLAY, firm, moist, abundant small roots</u>

GEOCON

MOISTURE / DENSITY TESTS

PROJECT NAME: Sonoma Casino

PROJECT NUMBER: S8689-06-01

DATE: 6-3-03 TESTED BY: PO

LAB NUMBER: 1687 SHEET 2 of 2

BORING NO.	TP-9	TP-10	TP-11	TP-12	TP-13		
DEPTH OF SAMPLE (ft)	3	1	4	3	1		
SAMPLE DIAMETER (in.)	2.4	2.4	2.41	2.39	2.41		
SAMPLE HEIGHT (in.)	5.02	5.7	4.7	5.05	5		
TARE NO.	AA-10	AA-6	K-3	AA-11	AA-7		
WET WT.+TARE (gm.)	711.2	812.9	891.1	755.9	695.5		
DRY WT.+TARE (gm.)	491.4	769	787.3	575.8	604.7		
TARE WT. (gm.)	112.9	112	135.8	110.8	111.3		
WT. OF WATER (gm.)	219.8	43.9	103.8	180.1	90.8		
WT. OF DRY SOIL (gm.)	378.5	657.0	651.5	465.0	493.4		
WATER CONTENT (%)	58.1%	6.7%	15.9%	38.7%	18.4%		
DRY DENSITY (PCF)	63.5	97.1	115.8	78.2	82.4		
	<u>Dark gray fat/organic CLAY, firm, moist</u>	<u>Very dark briwb silty fine SAND, med. Dense, moist</u>	<u>Olive brown lean CLAY, stiff, moist</u>	<u>Dark grayish brown fat CLAY, stiff, moist</u>	<u>Light olive brown silty lean CLAY, stiff, moist (some organics)</u>		



# UNCONFINED COMPRESSION TEST

Project Name: Sonoma Casino

Project Number: S8689-06-01

SAMPLE ID:	TP3-1
INITIAL HEIGHT (in.)	4.11
INITIAL DIAMETER (in.)	2.4
INITIAL AREA (in <sup>2</sup> )	4.524
VOLUME (in <sup>3</sup> )	18.593
MOISTURE CONTENT(%)	9.7
DRY DENSITY (pcf)	98.9

USCS:	CH
DESCRIPTION:	Very dark grayish brown to black Fat Clay
Maximum $\sigma_c$ :	5.562 psf
$\sigma_{max}$ :	2781 psf
$\sigma$ @ failure:	4.09% psf

2.78	tsf
1.39	tsf



**GEOCOON**  
 11375 Sunrise Park Drive  
 Rancho Cordova, CA 95742  
 Tel. 916.852-9118 Fax. 916.852.9118

Vertical Dial (0.001 inch)	Load Dial (Lbs.)	$\Delta L$ (inch)	Strain	Strain (%)	Corrected Area (in <sup>2</sup> )	$\sigma = P/A$ (psf)
0	0	0	0.000	0.00	4.524	0
10	11.8	0.01	0.003	0.29	4.537	375
20	23.2	0.02	0.006	0.57	4.550	734
30	35.7	0.03	0.009	0.86	4.563	1127
40	45.9	0.04	0.011	1.14	4.576	1444
50	57.2	0.05	0.014	1.43	4.589	1795
60	68.5	0.06	0.017	1.71	4.603	2143
80	93.8	0.08	0.023	2.29	4.630	2918
90	112.3	0.09	0.026	2.37	4.643	3483
100	128	0.1	0.029	2.86	4.657	3958
120	163.1	0.12	0.034	3.43	4.685	5014
140	182	0.14	0.040	4.00	4.712	5562
160	157.9	0.16	0.046	4.57	4.741	4796
180	130.7	0.18	0.051	5.14	4.769	3946
200	107.3	0.2	0.057	5.71	4.798	3220
220	91	0.22	0.063	6.29	4.827	2715

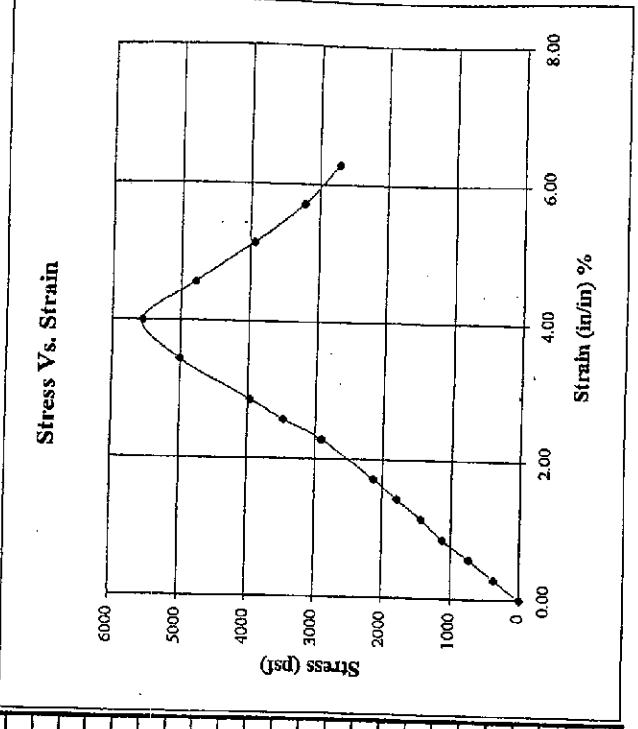

# UNCONFINED COMPRESSION TEST

Project Name: Sonoma Casino

Project Number: S8689-06-01

SAMPLE ID:	TP11-4
INITIAL HEIGHT (in.)	4.7
INITIAL DIAMETER (in.)	2.41
INITIAL AREA (in <sup>2</sup> )	4.562
VOLUME (in <sup>3</sup> )	21.440
MOISTURE CONTENT (%)	15.9
DRY DENSITY (pcf)	115.8

TSCS:	CL
DESCRIPTION:	Olive brown lean CLAY
Maximum c:	5.068 psf
T <sub>max</sub> :	2534 psf
e @ failure:	8.6%



11375 Sunrise Park Drive  
 Rancho Cordova, CA 95742  
 Tel. 916.852.9118 fax. 916.852.9118

Vertical Dial (0.001 inch)	Load Dial (Lbs.)	ΔL (inch)	Strain	Strain (%)	Corrected Area (in <sup>2</sup> )	σ=P/A (psf)
0	0	0	0.000	0.00	4.562	0
10	14	0.01	0.003	0.29	4.575	441
20	23	0.02	0.006	0.57	4.588	722
30	29.7	0.03	0.009	0.86	4.601	930
40	36.4	0.04	0.011	1.14	4.614	1136
50	44.3	0.05	0.014	1.43	4.628	1378
60	50.3	0.06	0.017	1.71	4.641	1561
70	57.6	0.07	0.020	2.00	4.655	1782
80	64.1	0.08	0.023	2.29	4.668	1977
90	71.2	0.09	0.026	2.57	4.682	2190
100	78.4	0.1	0.029	2.86	4.696	2404
120	92.2	0.12	0.034	3.43	4.724	2811
140	105.9	0.14	0.040	4.00	4.752	3209
160	118.3	0.16	0.046	4.57	4.780	3564
180	129.1	0.18	0.051	5.14	4.809	3866
200	139.4	0.2	0.057	5.71	4.838	4149
220	148.5	0.22	0.063	6.29	4.868	4393
240	158.5	0.24	0.069	6.86	4.897	4660
260	164.8	0.26	0.074	7.43	4.928	4816
280	170.7	0.28	0.080	8.00	4.958	4957
300	175.6	0.3	0.086	8.57	4.989	5068
350	164.1	0.35	0.100	10.00	5.069	4662
375	128.4	0.375	0.107	10.71	5.109	3619
400	100.5	0.4	0.114	11.43	5.150	2810
425	91.5	0.425	0.121	12.14	5.192	2538

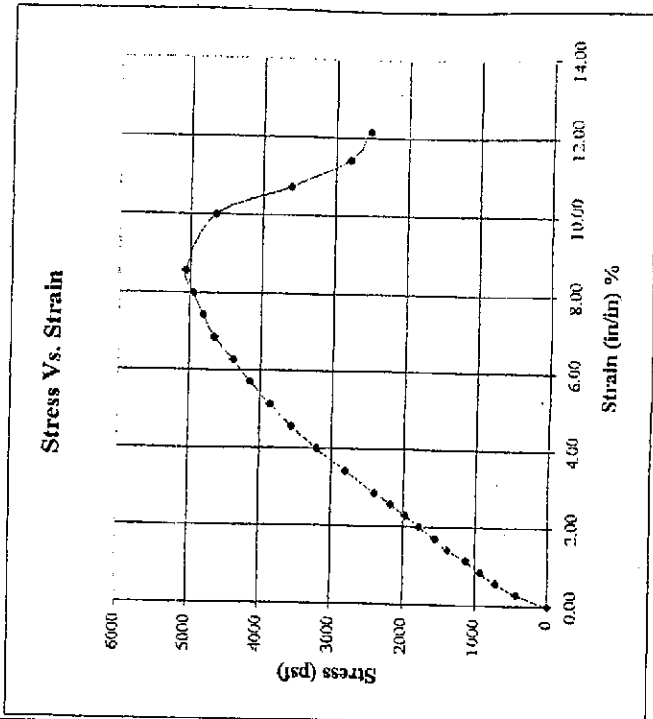

# LIQUID AND PLASTIC LIMITS TEST REPORT

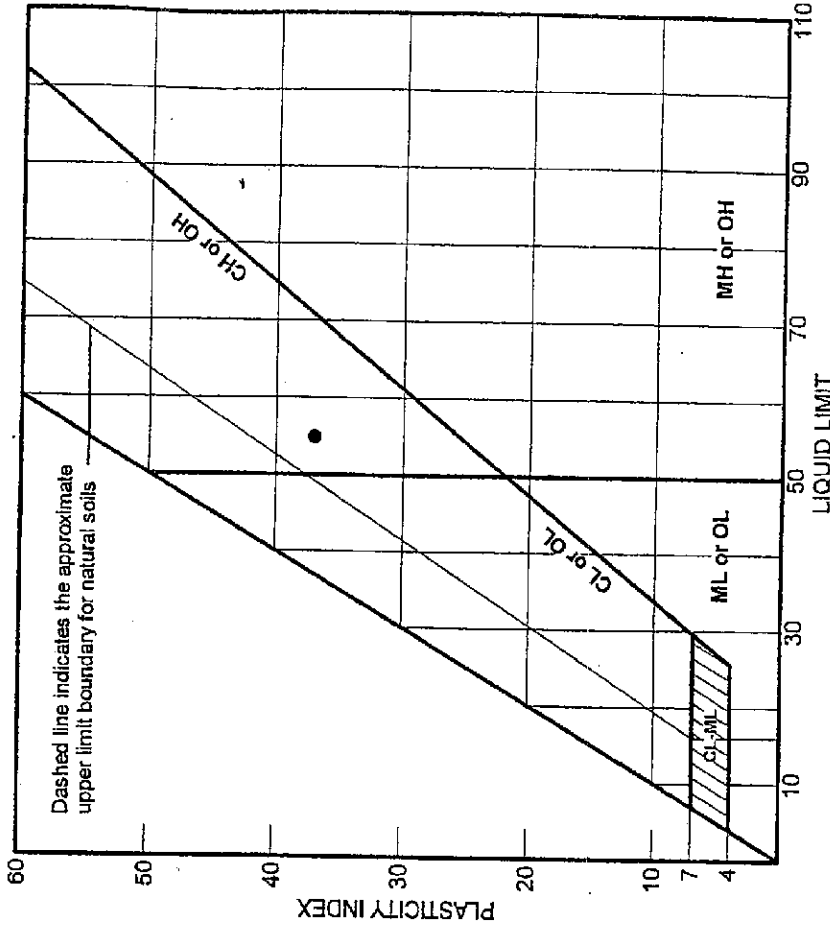
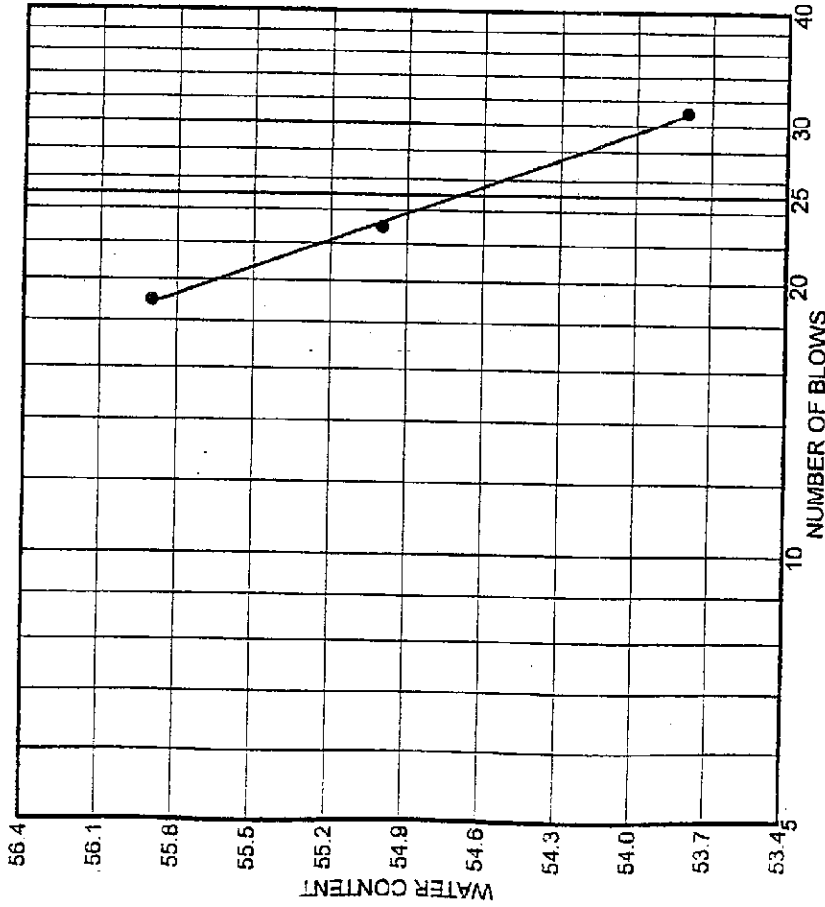

SOURCE	DEPTH/ELEV.	DATE SAMPLED	USCS	MATERIAL DESCRIPTION	NM %	LL	PI
TP1-14	1'	6-3-03	CH	Black fat CLAY		55	37

Client

Project Sonoma Casino

## GEOCON, INCORPORATED

Project No. S8689-06-01

Figure

# LIQUID AND PLASTIC LIMITS TEST REPORT

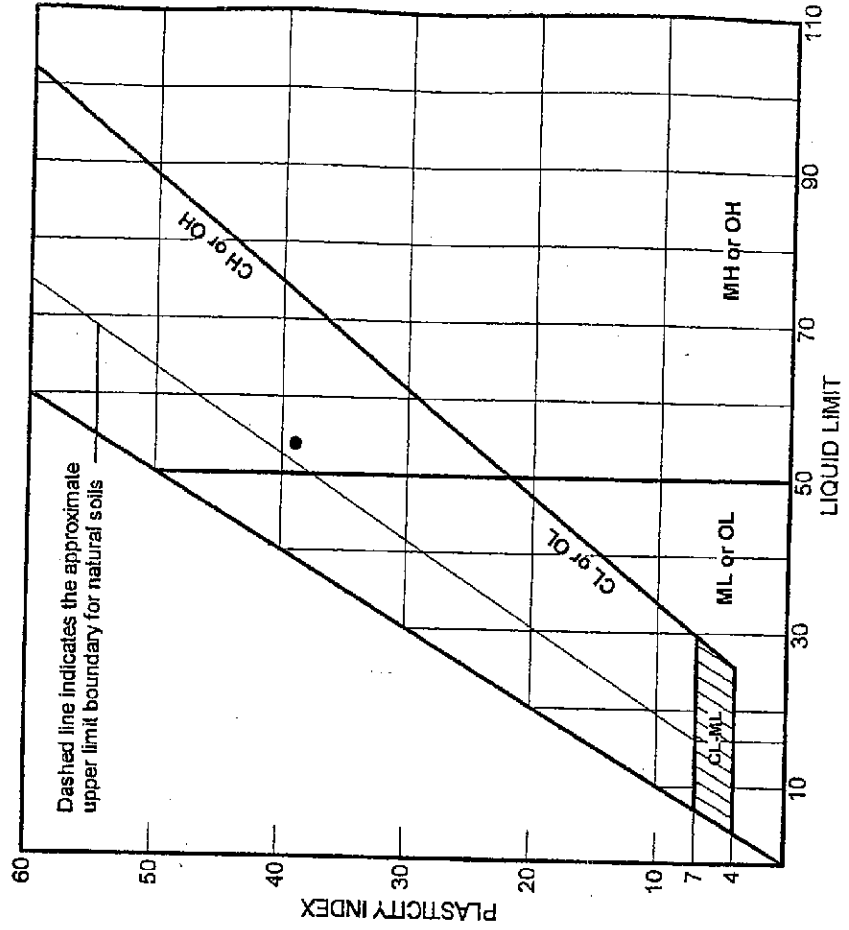
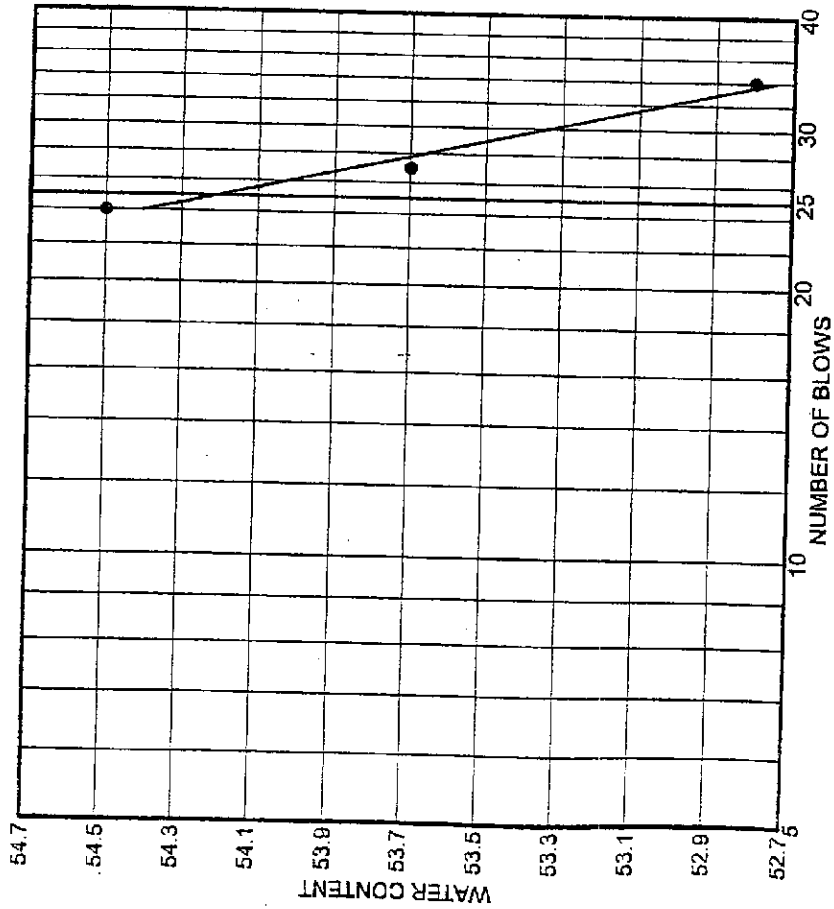

SOURCE	SAMPLE #	DEPTH/ELEV.	DATE SAMPLED	USCS	MATERIAL DESCRIPTION	NM %	LL	PI
TP1-14	TP4	4'	6-2-03	CH	Light olive gray FAT CLAY		54	39

Client \_\_\_\_\_

Project Sonoma Casino

**GEOCON, INCORPORATED**

Project No. 58689-06-01 Figure

# LIQUID AND PLASTIC LIMITS TEST REPORT

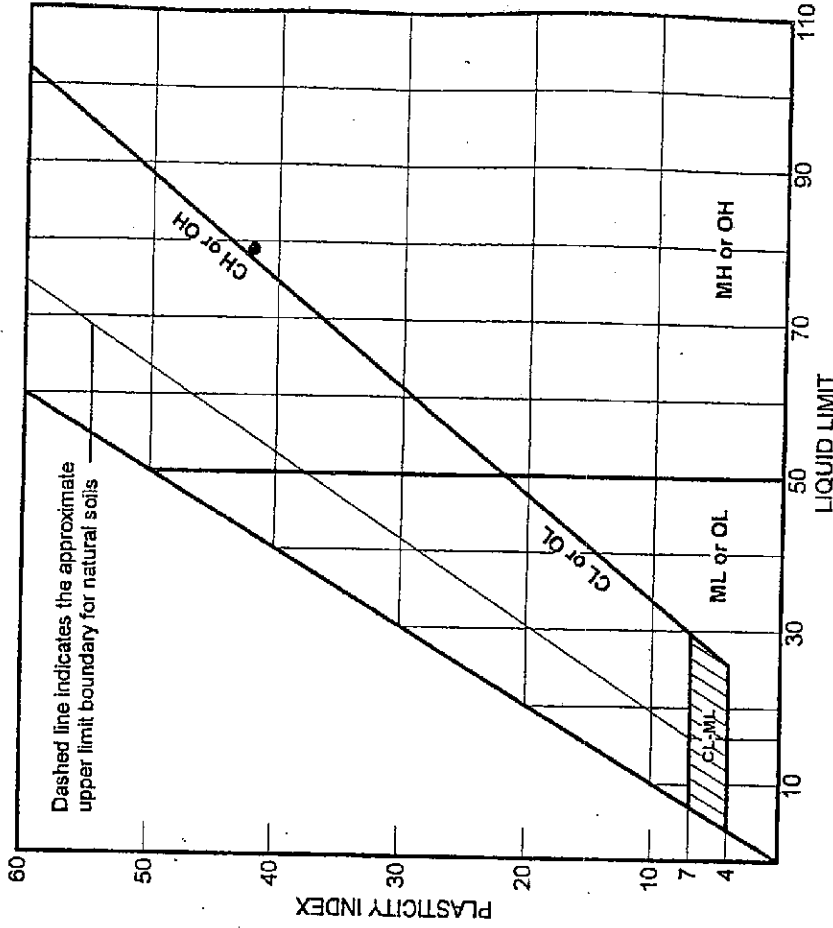
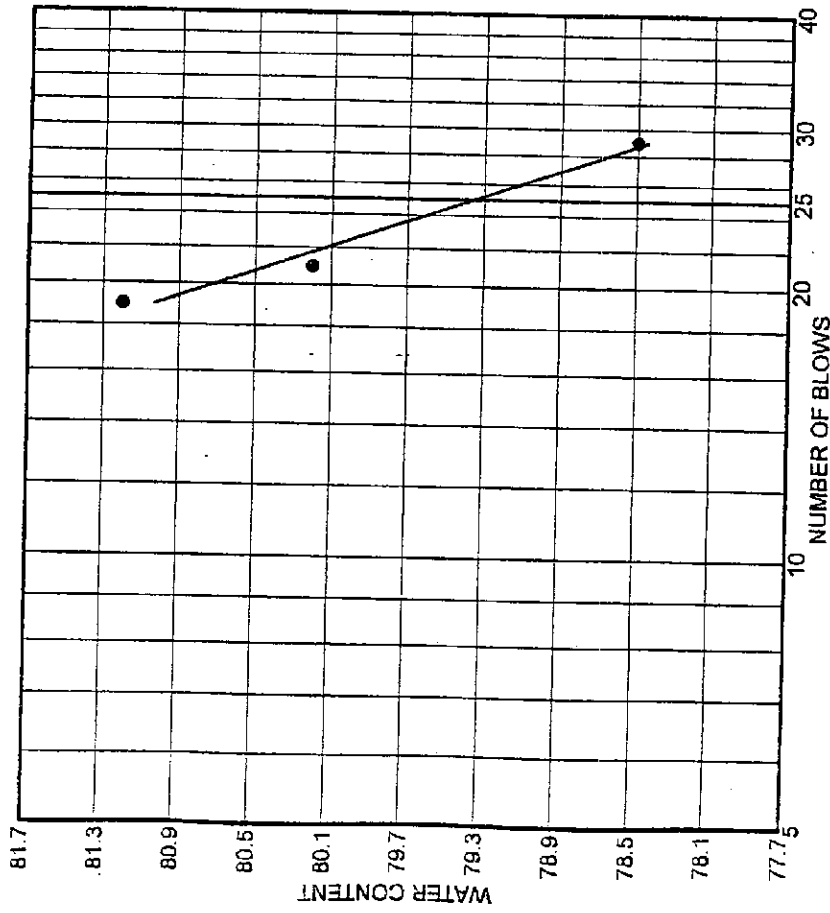

SOURCE	SAMPLE #	DEPTH/ELEV.	DATE SAMPLED	USCS	MATERIAL DESCRIPTION	NM %	LL	PI
● TPI-14	TP13	3'	6-2-03	OH	Very dark grayish brown organic CLAY		79	42

Client \_\_\_\_\_

Project Sonoma Casino

Project No. S8689-06-01

**GEOCON, INCORPORATED**

Figure

# CONSOLIDATION TEST

Project Name: Sonoma Casino  
 Project Number: S8689-06-01  
 Sample Number: TP6-3'

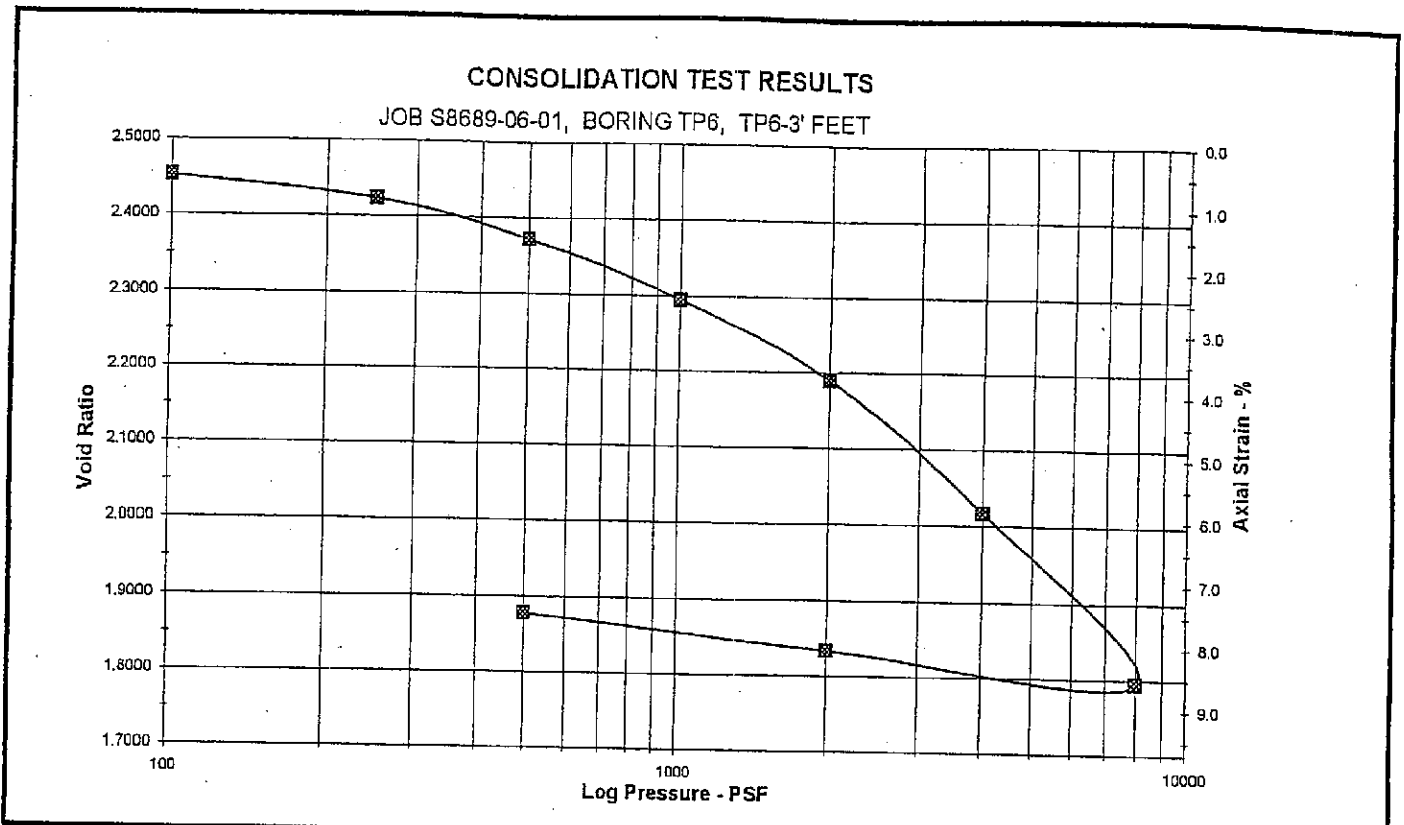

Axial Load (psf)	Void Ratio	Axial Strain (%)	$m_v$ , coef of vol Compres ( $\text{in}^2/\text{lb}$ )	$c_c$ , Comp Index	50% Consolidation		90% Consolidation	
					$t_{50}$ , Time to Consol (min)	$C_v$ , Coeff of Consol ( $\text{ft}^2/\text{yr}$ )	$t_{90}$ , Time to Consol (min)	$C_v$ , Coeff of Consol ( $\text{ft}^2/\text{yr}$ )
0	2.4607	0.00						
100	2.4520	0.25						
250	2.4234	1.08	0.0080	0.072	1.07	93.66	2.21	195.00
500	2.3717	2.57	0.0087	0.172	1.30	75.18	2.68	156.52
1000	2.2942	4.81	0.0066	0.258	1.09	86.35	2.25	179.78
2000	2.1890	7.85	0.0046	0.349	0.84	105.35	1.74	219.33
4000	2.0164	12.84	0.0039	0.573	0.88	92.22	1.82	192.01
			COND AT START OF TEST	COND AT END OF TEST	 11375 Sunrise Park Drive, Suite 100 Rancho Cordova, CA 95742 tel. 916-852-9118 fax. 916-852-9132			
HEIGHT (in.)			0.7500	0.6236				
MOISTURE CONTENT (%)			91.4	74.7				
DRY DENSITY (pcf):			45.1	54.2				
SATURATION (%)			93.0	99.6				
VOID RATIO			2.461	2.016				

*Wilfred Site – Geotechnical Engineering Investigation for  
Blackman Consulting*

**GEOTECHNICAL ENGINEERING  
INVESTIGATION  
Proposed Residential Development  
Wilfred Avenue  
Rohnert Park, California  
Northwest Specific Plan Area**

Prepared for:

Blackman Consulting  
1224 St. Helena Avenue  
Santa Rosa, California 95404

Attention: Mr. Kenneth R. Blackman

June 30, 2005  
Job No. 04-SR552



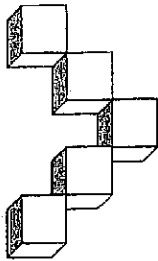

**Michelucci & Associates, Inc.**  
Geotechnical Consultants

**Daniel S. Caldwell, G.E.**

**Joseph Michelucci, G.E.**

**Richard Quarry**

June 30, 2005  
Job No. 04-SR552

Blackman Consulting  
1224 St. Helena Avenue  
Santa Rosa, California 95404

Attention: Mr. Kenneth R. Blackman

Re: Geotechnical Engineering Investigation  
Proposed Residential Development  
Wilfred Avenue  
Rohnert Park, California  
Northwest Specific Plan Area

At your request, we have conducted a geotechnical engineering investigation of the site of the proposed residential development (Northwest Specific Plan Area) on Wilfred Avenue in Rohnert Park, California. The purpose of our study was to evaluate the soil and groundwater conditions beneath the site so that geotechnical engineering recommendations could be provided for the proposed development of the property.

This report is based on numerous site reconnaissances, research, twenty exploratory borings drilled at the site, and laboratory testing conducted on samples collected from the borings.

We have enjoyed working with you on the project. Please call us if you have any questions regarding this report.

Very truly yours,  
**MICHELUCCI & ASSOCIATES, INC.**

*Daniel S. Caldwell*

Daniel S. Caldwell  
Geotechnical Engineer #2006  
(expires 9/30/05)

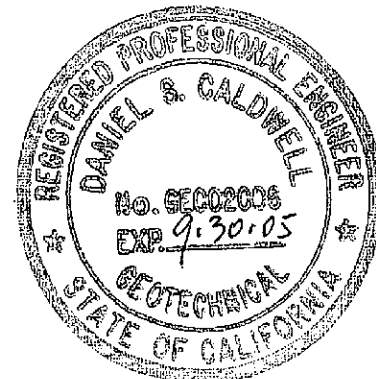

# **GEOTECHNICAL ENGINEERING INVESTIGATION**

## **Proposed Residential Development Wilfred Avenue Rohnert Park, California Northwest Specific Plan Area**

### **SCOPE**

This report presents the results of a geotechnical engineering investigation of the site of the proposed residential development, located south of Wilfred Avenue and west of Dowdell Avenue in Rohnert Park, California. The site is known as the Northwest Specific Plan Area. The purpose of the investigation was to evaluate the subsurface soil and groundwater conditions so that geotechnical engineering recommendations could be provided for the proposed development of the property.

This report includes recommendations for foundation design criteria, site preparation and grading, slab-on-grade construction, pavement design, surface drainage, and other aspects of the project that are related to soil and foundation engineering.

### **DESCRIPTION OF PROJECT**

The site of the proposed residential development encompasses approximately 95 acres. The property is generally bordered on the east by Dowdell Avenue, on the south by Business Park Drive, on the west by Langner Avenue, and on the north by Wilfred Avenue. The majority of the study area is currently undeveloped. However, several existing homes and associated buildings are located on the project site along portions of Dowdell Avenue, Wilfred Avenue, and Labath Avenue. The remainder of the study area supports a growth of wild grasses and weeds.

The surface topography at the site is generally flat to slightly sloping. The existing ground surface appears to generally slope down gradually toward the south. No specific or detailed topographic information was available for the property at the time of our investigation.

We understand that the property will principally be developed as a residential subdivision, possibly including low density, medium density, and high density development. The development of the property may also include the construction of a park, and an area of mixed use development. The project will also include underground utilities, residential streets, and other infrastructure improvements. We understand that residential structures would typically be one or two story, woodframe construction. It is anticipated that residential foundations would consist typically of post-tensioned concrete slabs-on-grade, although drilled pier foundations and raised wood floors may be used. Details of the mixed use area of the site are not currently available. However, it is anticipated that any commercial structures would be supported on conventional spread footing foundations and would have concrete slab-on-grade lower floors.

It is anticipated that some grading will be required to create building pads and the new roadways and to develop proper drainage. It is anticipated that cuts and fills will typically be no more than four to six feet in depth.

#### **FIELD INVESTIGATION AND LABORATORY TESTING**

Numerous site reconnaissance's were undertaken by our geotechnical engineer and staff to evaluate the surface topography and to map the surface soil visible on the site. Research was undertaken to review published geologic and fault data relative to the site, and to review files for other projects our firm has completed in the project area. Subsequent to the preliminary reconnaissance work, twenty exploratory borings were drilled at selected locations on the site.

The exploratory borings were excavated at the approximate locations shown on the site plan sketch, Figure 1. The borings were drilled with a truck or track mounted, 6 inch diameter solid stem power auger or 8 inch diameter hollow stem power auger, and were extended to depths ranging from 2.5 to 32 feet. As the borings were drilled, relatively undisturbed samples of the various soil layers encountered were taken using a 2 or 2.5 inch diameter sampler or a standard penetration sampler. The sampler was driven into the ground using a 140 pound weight dropped 30 inches. The resistance to penetration of the sampler is recorded on the logs of borings. The logs of the borings, Figures 2 through 21, are the result of editing of the field logs based on a closer examination of the soil in our laboratory and on the results of the tests performed on some of the samples. It should be pointed out

that the soil conditions between the exploratory borings had to be estimated by interpolation, and variations of the soil conditions between the borings are certainly possible.

The samples that were recovered from the borings were brought to our laboratory for testing. The laboratory tests performed on some of the samples included unconfined compressive strength, moisture content, and dry density determinations. Atterberg Limits tests were conducted on two samples representative of the surface soil at the site, and an Expansion Index test was conducted on one representative sample of surface soil. These tests were used to evaluate the engineering characteristics of the soil as they relate to expansion potential, compressibility, and liquefaction potential. The results of the laboratory tests are shown at the corresponding sample locations on the logs of borings, Figures 2 through 21. The results of the Atterberg Limits tests are shown on Figure 22, and the results of the Expansion Index test are shown on Figure 23.

### SITE AND SOIL CONDITIONS

The existing ground surface topography on the subject site is nearly level to slightly sloping. Based on a visual evaluation only, the site appears to slope down generally toward the south.

The majority of the subject property is currently vacant of structures. However, several existing homes and associated buildings are located on the site along portions of Dowdell Avenue, Wilfred Avenue, and Labath Avenue. The remainder of the site is currently vacant (apparently never developed), and supports a growth of weeds and wild grasses. We understand that the property has historically been used for agricultural purposes.

Artificial fill mantles a small portion (perhaps 5 acres) of the surface of the site near the mid-southern portion of the site along Labath Avenue (see exploratory boring 11). The fill is typically soft to medium stiff brown to dark brown silty clay to sandy clay with wood and concrete debris, and varies from zero to approximately two feet thick.

The natural surface soil consists of medium stiff to stiff dark brown to black silty clay typically having a thickness of roughly three to five feet. The natural topsoil has high plasticity and high expansion potential.

Based upon the twenty exploratory borings drilled at the site during our study, the natural soil conditions beneath the dark brown to black silty clay topsoil layer consist of alternating layers of stiff gray brown and tan brown gravelly clayey silt/sandy silt and medium dense to dense brown to dark brown gravelly silty sand/clayey sand. The soil encountered in the borings is typical of an alluvial soil deposit. No loose or soft layers were encountered below a depth of roughly four feet beneath the existing ground surface, to the maximum depth explored (32 feet).

Groundwater was encountered in some of the exploratory borings at the time of drilling. It is anticipated that the groundwater level beneath the site will vary seasonally, and that the groundwater level would be somewhat higher during the rainy winter months and into the spring.

For a more detailed description of the soil and groundwater conditions beneath the site, refer to the boring logs, Figures 2 through 21.

## **SEISMICITY**

### **1. General**

The seismic activity of Sonoma County, as well as the entire North Coast region, is the result of readjustments to opposing forces along various northwest trending strands of the San Andreas Fault between the North American and Pacific crustal plate boundary. Release of accumulated intercrustal stress is accomplished either through intermittent earthquakes or continuously reduced through aseismic creep along the wide belt of northwest striking faults, collectively known as the San Andreas Fault System.

#### **A. Alquist-Priolo Faults**

Nearby faults of the San Andreas system that could potentially produce a hazardous groundshaking event, and that have been addressed by the Alquist-Priolo Special Studies Zone (APSSZ) Act of 1972 include: the San Andreas Fault and the Rodgers Creek Fault.

### **San Andreas Fault:**

The San Andreas Fault, which is located approximately 15 miles southwest of the site, has produced a maximum historical earthquake of magnitude 8.25. This fault is considered capable of producing a maximum credible earthquake of 8.5 and has an estimated recurrence interval of 100 to 1000 years (Wesson and others, 1975). The San Andreas Fault is considered responsible for the magnitude 7.1 Loma Prieta earthquake centered 10 miles north of Santa Cruz on October 17, 1989. This fault is not confined to a single trace; it consists of a wide zone of fault planes and is approximately 750 miles in total length.

### **Rodgers Creek Fault:**

The Rodgers Creek Fault is located approximately 3 miles northeast of the site. This fault was responsible for a 5.9 magnitude earthquake centered near Santa Rosa in 1969. The maximum credible earthquake along this fault is believed to be a magnitude 7.5.

## **2. Primary Seismic Effects**

No faults considered active in the Holocene Epoch have been previously mapped at the site. Furthermore, we found no geomorphic evidence suggestive of recent surface rupture during our site visits. Based on these criteria, we believe that there is little probability of fault rupture occurring at the surface of the proposed development.

The site will be subject to strong ground shaking during a significant seismic event on one of the nearby active faults. Structures should be designed for ground motion in accordance with the latest Uniform Building Code requirements. For 1997 UBC design purposes, the following criteria should be assumed: 1) Soil Profile Type Sd; 2) Seismic Source Type A; and 3) closest distance to known seismic source is 5 kilometers.

## **3. Secondary Seismic Effects**

Due to the presence of sandy soil and high groundwater beneath the subject site, we have considered the potential for liquefaction to occur at the site during a seismic event. In general, the soil layers beneath the site are either dense enough or contain a sufficient percentage of fine grained (clayey) soil

to not be subject to liquefaction. Therefore, in our opinion, the risk of liquefaction is low.

### **DISCUSSION AND CONCLUSIONS**

In our opinion, the site is suitable for the proposed construction. The upper roughly three to four feet of the natural topsoil that mantles the site is soft and disturbed (disked and/or desiccated), and would be subject to settlement under the weight of fill or new building loads. Therefore, the existing weak topsoil will need to be processed (scarified, moisture conditioned, and recompacted) prior to placing new fill or constructing residential foundations. The soil below a depth of four feet will not be subject to settlement under the anticipated loading conditions imposed by the proposed development.

The natural surface soil at the site has high expansion potential. Expansive soil shrinks and swells seasonally as the moisture content changes, and this can cause damage to shallow footings and concrete slabs-on-grade. Therefore, building foundations should be designed to account for expansive soil conditions. The use of lime treatment could be considered to reduce the expansion potential and improve the strength of the surface soil. We can provide recommendations for lime treatment, if you desire.

We recommend that existing septic tanks (if any), and any loose, disturbed soil surrounding septic tanks, be removed prior to development. The septic tank excavations should be backfilled with compacted, engineered fill as recommended below. We recommend that old leach field areas also be removed, particularly within proposed building footprint areas and 10 feet beyond building lines. Any existing wells at the site should be abandoned in accordance with the Sonoma County Health Department standards. We recommend that when wells are larger than two feet in diameter, the bottom of the well should be probed to ensure that it is free of excessive soft debris prior to backfilling the well. Finally, disturbed soil surrounding removed tree stumps and old foundations (if any) should be overexcavated and replaced with engineered fill.

In our opinion, post-tensioned concrete slab-on-grade foundations supported on stiff natural soil or compacted fill may be used for residential construction. Alternatively, drilled, cast-in-place, reinforced concrete piers and concrete grade beams can be used for foundation support. Commercial

structures can be supported on conventional spread footing foundations and can have conventional concrete slab-on-grade floors, provided that the upper 36 inches of the building pad is composed of select, nonexpansive fill or lime-treated native soil.

Specific recommendations for geotechnical engineering design criteria are given in the following section.

## **RECOMMENDATIONS**

### **1. Grading and Site Preparation**

All grading and site preparation should be done under the direct observation of our field representative and in accordance with the attached "Guide Specifications for Engineered Fills". It is the contractor's responsibility to complete the grading in accordance with the job specifications. Our representative will observe the grading and take a random number of tests each day in order to provide an opinion to the owner regarding the conformance of the grading to the specifications. When we feel that the grading does not meet the specifications, the contractor should rework the area to our satisfaction.

All engineered fill should be placed in thin lifts not exceeding 6 to 8 inches in uncompacted thickness, brought to a moisture content that will permit proper compaction, and each lift should be compacted until a minimum degree of compaction of 90% is achieved, based on ASTM Test Method D1557.

The top 6 inches of soil in pavement areas should be compacted to 95% (ASTM D1557) just prior to placement of the baserock, as discussed below under "Pavements".

Prior to placing fill, any vegetation and debris should be stripped so that the site is clean. We estimate that the typical stripping depth will be approximately 3 inches. Deeper stripping may be required around existing trees (where they are being removed), or around existing foundations, septic tanks, leach fields, or other existing features that are being removed. The stripped material should not be used as engineered fill, but it may be stockpiled for later use as topsoil in nonstructural areas.



Any cracked or saturated surface soil should be overexcavated and processed prior to placing fill. We estimate that the depth of desiccation cracking in mid to late summer may be as much as four feet beneath the existing ground surface. It is critically important that all desiccated soil be moisture conditioned, mixed, and recompacted at a moisture content of at least 3 to 5 percent over optimum. In addition, any existing fill or weak surface soil should be overexcavated in the proposed building pad areas prior to placing new fill or constructing building foundations.

After any necessary overexcavation has been completed, the subgrade should be scarified, brought to a moisture content of 3 to 5 percent over optimum, and then it should be compacted to a minimum degree of compaction of 90% (ASTM D1557). Fill can then be placed on the prepared subgrade in lifts not exceeding 6 to 8 inches in uncompacted thickness. Each lift should be brought to a moisture content that will permit proper compaction, and then be compacted to a minimum degree of compaction of 90% (ASTM D1557). Clayey fill should be placed at a moisture content of 3 to 5 percent over optimum.

Cut and fill slopes (if any) should be constructed no steeper than 3 horizontal to 1 vertical.

Fill placed behind retaining walls (if any) should also be placed in thin lifts not exceeding 6 to 8 inches in uncompacted thickness, brought to a moisture content that will permit proper compaction, and then be compacted to a minimum degree of compaction of 90% (ASTM D1557). Backfill placed within 10 feet of existing retaining walls should be compacted with light weight (hand operated) compaction equipment to minimize loads on the walls during construction.

Import fill, if required, should meet the requirements set forth in the attached "Guide Specifications for Engineered Fill" for either general fill or select fill. A sample representative of the import material should be provided to our office prior to the commencement of importation in order that the necessary laboratory tests can be conducted to verify that the soil meets the requirements for its intended use.

It is noted that some of the soils on the site are clayey and may be difficult to adequately compact when the moisture content is high, particularly during the winter months. Therefore, it should be anticipated that some spreading

and drying will be necessary in order to achieve proper compaction of clayey fill. Conversely, moisture may have to be added to the soil, particularly during the summer months, to achieve proper compaction.

We estimate that a shrinkage factor of approximately 10 percent would be appropriate for use in cut/fill volume calculations, for the upper zone of soil that is processed prior to placing new fill.

It is noted that the recommended moisture conditioning of any desiccated soil at the surface of the site may have an impact on calculated cut and fill volumes, due to swell of the desiccated soil upon moisture conditioning.

It is recommended that the surface of all freshly graded areas be protected with surface vegetation or other erosion control material prior to the first rainy season to minimize surface soil erosion on the site.

## **2. Residential Building Foundations**

Provided that the site is graded as recommended above, the proposed residential structures can be supported on post-tensioned concrete slab-on-grade foundations bearing on engineered fill or stiff natural soil. We recommend that post-tensioned slabs be designed in accordance with the Post-tensioning Institute's latest design manual for Design and Construction of Post-tensioned Slabs on Ground. We recommend that post-tensioned slabs have a minimum thickness of 12 inches, or greater as required by the project structural engineer and PTI design standards. A thickened edge and intermediate beams should be included for stiffening.

The following soil values may be assumed for design of post-tensioned slabs: 70 percent clay content (montmorillonite) in surface soil; Atterberg Limits properties (Liquid Limit = 75, Plastic Limit = 18, and Plasticity Index = 57); depth to constant suction is 6 feet; value of soil suction is 3.6; velocity of moisture flow is 0.7 inches per month.

We recommend that an allowable soil bearing pressure of 1,000 pounds per square foot be used. A coefficient of friction of 0.35 can be assumed between the base of the slab and the soil.

Alternatively, new residential structures may be supported on drilled, cast-in-place, reinforced concrete pier foundations. Concrete grade beams can be

used to carry building loads to the piers. We recommend that drilled piers have a minimum diameter of 12 inches and a minimum depth beneath the lowest adjacent finished grade of 10 feet. Piers can be designed on the basis of skin friction acting on that portion of the peripheral area of the pier that extends below a depth of 48 inches below the lowest adjacent finished grade (neglect the top 48 inches in vertical support). A skin friction value of 500 psf can be used for combined dead plus live loading. No end bearing resistance should be assumed in calculating the vertical load bearing capacity of the piers. The actual embedment depth of each pier should be designed based upon the allowable skin friction and on the actual building loads carried by each pier. The plans should show the required embedment of each pier into supporting soil. For a 12 inch diameter pier extending to the minimum recommended depth of 10 feet, the vertical load bearing capacity per pier would be 9,425 pounds.

Building loads can be carried into the piers using reinforced concrete grade beams extending across the tops of the piers, or carried through timber framing to isolated piers in the interior of the structures. The grade beams should be designed to span from one pier to the next, and not rely on the soil between piers for support. A minimum 4 inch void should be formed beneath the grade beams (between piers) using an approved forming material to minimize potential uplift loads against the bottom of the grade beams. Care should be taken to avoid the formation of enlarged concrete "collars" around the tops of piers.

Resistance to lateral loads can be generated by passive pressure acting against 1.5 times the projected area of the pier, starting at a depth of 48 inches below the lowest adjacent finished grade. The passive resistance can be assumed to be an equivalent fluid pressure of 300 pounds per cubic foot.

### **3. Commercial Building Foundations**

We recommend that in each commercial building area, and extending 5 feet beyond the building lines in all directions, that the native clayey surface soil be overexcavated as necessary to allow for the placement of 36 inches of select, nonexpansive fill beneath the building slabs (30 inches of select fill and 6 inches of moisture-retarding treatment). After the recommended overexcavation is completed, the clayey subgrade should be brought to a moisture content of 3 to 5 percent above optimum, and be compacted to a

minimum degree of compaction of 90% based upon ASTM D1557. The select fill should be placed in 6 inch lifts and also be compacted to at least 90%.

As an alternative to placing 30 inches of select fill and a 6 inch moisture-retarding treatment beneath the building floor slab area, the native subgrade soil can be lime-treated. It is noted that site specific laboratory testing has not been conducted to provide final design recommendations for lime-treatment of the native clayey soil. However, based on our experience with similar soil, the upper 30 inches of native clayey soil beneath the building area, and 5 feet beyond the building lines in all directions, should be thoroughly mixed with 5 percent (by weight) high-calcium lime. The lime treating process will have to be conducted in at least two lifts, each lift having a thickness of no more than 18 inches. The lime should be mixed into the native clayey soil using a rotary type mixer. The lime treated soil should be tested prior to the construction of the slabs to verify that the maximum plasticity index of the treated soil is 12. A 6 inch thick moisture-retarding treatment should be placed over the lime-treated pad, as discussed below under slab-on-grade construction.

If all existing weak surface soil is removed from the building areas, the proposed commercial structures can be supported on spread footing foundations bearing on the stiff natural soil or on engineered fill. The footings should extend to a minimum depth of 24 inches below the lowest adjacent rough pad grade. The above depth criteria should exclude any topsoil placed around the foundations for landscaping purposes. Footings located on or near slopes should be deepened so that a minimum 10 feet of horizontal confinement is maintained between the face of the footing and the adjacent slope.

Footings constructed in engineered fill or stiff lime-treated natural soil at the recommended minimum depth may be designed for a maximum allowable soil bearing pressure of 1,500 psf for dead loads, and 2,250 psf for dead plus live loads. An increase of 33% above this value can be used for all loads, including wind or seismic.

Resistance to lateral loading can be generated by passive pressure against the front face of the footing and by friction along the base of the footing. Passive resistance can be assumed to be an equivalent fluid pressure of 300 pcf, neglecting the top one foot below the lowest adjacent finished grade. A

coefficient of friction of 0.35 can be used. The above are ultimate values, and a suitable factor of safety should be applied in the design.

Floor slabs can be designed using a modulus of subgrade reaction of 250 pounds per cubic inch, provided that the select fill beneath the slab is compacted to a minimum degree of compaction of 90 percent (ASTM D1557). If the upper 12 inches of select fill beneath the slab is compacted to a minimum degree of compaction of 95 percent, a modulus of subgrade reaction of 300 pounds per cubic inch may be used. If lime-treated native soil is used beneath the slabs, and the upper 12 inches of the lime-treated soil is compacted to a minimum degree of compaction of 95 percent, a modulus of subgrade reaction of 250 pounds per cubic inch may be used.

It is recommended that a moisture retarding treatment be provided beneath interior slab-on-grade floors where moisture would be undesirable. A minimum but commonly used treatment is illustrated on Figure 25. The moisture retarding treatment can make up the upper 6 inches of the select fill layer (select fill or lime-treated soil plus moisture retarding treatment combined thickness should be 36 inches). It should be pointed out that other, more expensive but possibly more effective, methods have been used in some cases, and the architect should make the final decision regarding moisture prevention based on the needs of the project. Our contribution in this matter is only to point out that moisture will be available at the base of slabs from the subgrade soil due to groundwater conditions and capillary rise.

#### **4. General Slab-on-Grade Construction**

As discussed, the surface soil on the site is generally high in plasticity and expansion potential. It is critical that the moisture content of the compacted building pads be maintained until the concrete slab foundations are constructed, in order to minimize the post construction swell potential. Any concrete slabs-on-grade not designed as recommended above for expansive soil conditions, such as garage slabs or patio/walkway slabs, will be subject to heave and cracking. We recommend that garage slabs and exterior slabs be designed somewhat thicker than normal (5 inches minimum) with steel rebar reinforcing. Slab subgrades should be thoroughly soaked just prior to construction. Garage slabs should be constructed structurally separate from the adjacent home foundation to minimize distress at the connections.

It is recommended that a moisture retarding treatment be provided beneath interior slab-on-grade floors where moisture would be undesirable, including garage slabs. A minimum but commonly used treatment is illustrated on Figure 25. It should be pointed out that other, more expensive but possibly more effective, methods have been used in some cases, and the architect should make the final decision regarding moisture prevention based on the needs of the project. Our contribution in this matter is only to point out that moisture will be available at the base of slabs from the subgrade soil due to groundwater conditions and capillary rise.

It should be pointed out that where the gravel moisture retarding layer is placed beneath slabs, there is a possibility that water will tend to collect in the gravel layer and become trapped. If this condition occurs, the potential for moisture problems in the slab will be increased. One method of minimizing the potential for this to occur would be to construct a subdrain trench through and just below the gravel layer so that water collected in this area can escape. The subdrain should extend at least 12 inches below the base of the slab and 6 inches below the bottom of the gravel, and would consist of a 4 inch diameter, perforated pipe surrounded by gravel. Details of subsurface drains are given in the attached "Guide Specifications for Subsurface Drains". The subdrain would connect to the recommended moisture retarding treatment under the slab, and the pipe should lead to a storm drain or low area on the site. The choice of installing the subdrain facilities should be based on an evaluation of the detrimental effect, if any, of dampness in the slab.

## **5. Surface Drainage**

It is important that careful attention be given to surface drainage considerations on all aspects of the project. We recommend that all roof rain gutter downspouts be connected to nonperforated pipes that lead to suitable storm drainage facilities. Surface gradients should be designed such that there is always a positive slope away from any buildings and away from pavements. We recommend that the finished ground surface surrounding homes should have a minimum slope of 4 percent for a minimum distance of 4 feet away from the foundations.

We have observed on past projects that numerous drainage problems in the form of moisture under buildings and pavement failures have occurred due to

the design and construction of landscape and irrigation improvements after the basic grading has been completed. Planting areas that drain toward pavements cause water to collect in the baserock layer, and this directly results in pavement failures, even under light traffic. The same considerations also apply to depressed areas beneath buildings and to gravel layers beneath floor slabs. Any low areas on the site should be provided with catch basins that lead by nonperforated pipes to suitable drainage facilities. We recommend that the soil in crawl spaces (if any) beneath homes be sloped to drain to one or more outlet points through or beneath the foundation so water will not become trapped in the crawl space areas. In general, water should not be allowed to pond at the tops of slopes or to flow over the faces of slopes.

Details of surface drainage are to be designed by the civil engineer and are beyond the scope of our assignment. The recommendations of this section are intended to provide only general guidelines for drainage control measures.

## **6. Utility Trench Backfill Construction**

If settlement is to be avoided, backfill placed in utility trenches should be compacted to a minimum degree of compaction of 90% (ASTM D1557) from 2 feet above the top of the pipe to the finished grade. In the case that utility trenches are located in paved areas, the upper 6 inches of backfill below the pavement subgrade level should be compacted to a minimum degree of compaction of 95% (ASTM D1557).

Either on-site soil or imported granular fill can be used as trench backfill material (subject to approval by the governing jurisdiction). It is noted that if on-site clayey soil is used for trench backfill, jetting would not be expected to achieve the compaction specification of 90%. We would anticipate that the on-site silty material would have to be placed in relatively thin lifts and compacted with a whacker or other mechanical compaction device to achieve the specified degree of compaction.

As mentioned, imported granular fill material could also be used to backfill utility trench excavations. Granular fill material would be easier to compact in small excavations. If granular fill material is used, the fill should be placed in layers and compacted to a minimum degree of compaction of 90%. It is possible that jetting of granular backfill, such as sand, in the utility trenches

would achieve the recommended degree of compaction. Many times, utility contractors choose to place granular fill in one lift, and then jet the backfill to achieve the specified degree of compaction. In this case, test pits would have to be excavated at various levels within the backfill, at some reasonable spacing along the trench line, so that field density tests could be taken in the backfill to sample the degree of compaction that is being achieved.

Preparation of the bedding layer of the utility pipes and the placement of shading and cover over the pipe should be undertaken according to the standard specifications of the various utility districts, and plumbing manufacturers that would have jurisdiction over the various utilities.

## **7. Pavements**

The required Traffic Indices for pavement design have not yet been established for the new streets within the project. Therefore, we are providing recommended pavement structural sections for design Traffic Indices of 5.0, 6.0, and 7.0. An "R-value" of 5 is assumed for the expansive dark brown to black silty clay surface soil at the site. When the street subgrade elevations are known, and if more favorable soil conditions will be exposed at the subgrade level, R-value testing can be undertaken to justify a higher value for final design.

For a Traffic Index of 5.0, we recommend that the pavement structural section consist of 0.25 feet of asphaltic concrete underlain by 0.85 feet of Class 2 aggregate base rock. For a Traffic Index of 6.0, the structural section should consist of 0.30 feet of asphaltic concrete underlain by 1.05 feet of Class 2 aggregate base rock, and for a Traffic Index of 7.0, we recommend that the pavement structural section consist of 0.35 feet of asphaltic concrete underlain by 1.25 feet of Class 2 aggregate base rock. The recommended sections include an increase of 0.20 feet of the gravel equivalent of the asphalt concrete layer as a safety factor.

It is noted that the above recommended pavement sections could be significantly reduced if the clayey subgrade soil is lime-treated. Experience on other projects with similar soil conditions has shown that an 'R'-value in the range of 40 to 50 can be achieved in lime-treated clayey subgrade soil. More detailed design recommendations for lime-treatment can be provided, if this approach is chosen. Detailed design recommendations should be based on additional site and soil specific laboratory testing.



Prior to placing the pavement section, the subgrade should be scarified to a minimum depth of 6 inches, brought to a moisture content that will permit proper compaction, and then the upper 6 inches should be compacted to a minimum degree of compaction of 95% (ASTM D1557). It is emphasized that the compaction of the subgrade soil should be undertaken just before placement of the baserock and pavement so that the construction activities will not cause disturbance which could destroy the compaction of the subgrade. The base rock should also be compacted to a minimum degree of compaction of 95%.

It should be pointed out that many pavement failures occur on projects because water collects in the baserock layer beneath the pavements. In many cases, this water is generated from adjacent landscape water that percolates in the topsoil layer and then flows laterally under curbs and into the relatively pervious baserock layer. Careful attention should be given to the surface drainage gradients to see that water is directed away from the edges of pavements. A moisture barrier can be constructed at the edges of pavements to inhibit the flow of surface water to the baserock layer.

Where possible, pavement areas should not be designed with central valley drainage, but rather they should slope to one side or the other. Valleys in the middle of pavement areas tend to result in water collecting in the baserock layer beneath the valley, and this results in pavement failures.

It should also be pointed out that pavements are often subjected to the heaviest loading conditions during the actual project construction, when heavy wheel loads of concrete trucks and other equipment cross the pavements. Therefore, construction scheduling should be considered, and it may be desirable to plan on a pavement overlay after construction of the project has been completed so that the finished pavements will be smooth.

In order to minimize the risk of lateral soil creep adversely impacting pavements, curbs/gutters, and sidewalks, a level bench at least 15 feet wide should be provided between the edges of pavements or sidewalks and the tops of any adjacent downslopes, where the slopes are less than 5 feet high. The purpose of the recommended bench is to provide lateral back-up or support to the pavements and other improvements to prevent lateral spreading and damage that can otherwise occur due to soil creep in the expansive native clayey soil.

## **8. Construction Considerations and Review of Plans**

It is recommended that the foundation and grading plans for the proposed development be submitted to our office for review. The purpose of this review would be to determine that the intent of our recommendations has been understood and is reflected on the drawings. At that time, any specific details of the project that may not have been covered by the recommendations given in this report should be brought to our attention so that appropriate supplemental recommendations can be made.

It is also recommended that the foundation excavations be examined by our representative prior to construction of footings or slabs-on-grade. This would enable us to verify our assumptions regarding the soil conditions and to see that the foundations are bearing on the recommended material. As mentioned, all grading work should be performed under our direct observation.

Proper moisture conditioning during site preparation and grading, and maintenance of moisture in the soil beneath building pads and pavements, is critical to the performance of the planned foundations and pavements. We recommend, therefore, that our representative observe the moisture condition of pavement subgrade soil just prior to the placement of baserock, and that our representative observe the moisture condition of building pads just prior to the placement of the capillary break/vapor barrier and construction of the concrete floor slabs.

As discussed, it should be anticipated that some of the soil at the site may be too wet to compact, particularly during the winter months. Therefore, some spreading and aeration of the soil may be required before proper compaction can be achieved. Conversely, some of the soil may have to be moisture conditioned by adding water prior to compaction.

### **LIMITATIONS**

The conclusions and opinions in this report are based on the exploratory borings that were made on the site, spaced as shown on the site plan sketch, Figure 1. While in our opinion these borings adequately disclose the soil conditions across the site, the possibility exists that anomalies or changes in the soil conditions which were not discovered by this investigation could

occur between the borings. Should such items be discovered during construction, our office should be notified immediately so that any necessary supplemental recommendations can be made.

This study was not intended to disclose the locations of any existing utilities, septic tanks, leaching fields, or other buried structures. The contractor or other people working on the project should locate these items, if any.

This study was not intended to delineate the presence of toxic contamination in the soil and groundwater at the site. No environmental testing of the soil and groundwater was undertaken in the present scope of work. In order to determine if toxic contamination exists in the soil and groundwater at the site, much more detailed environmental testing and investigation would be required.

This report was prepared to provide engineering opinions and recommendations only. It should not be construed to be any type of guarantee or insurance.

# Site Plan Sketch

Northwest Area, Wilfred Avenue  
Rohnert Park, California

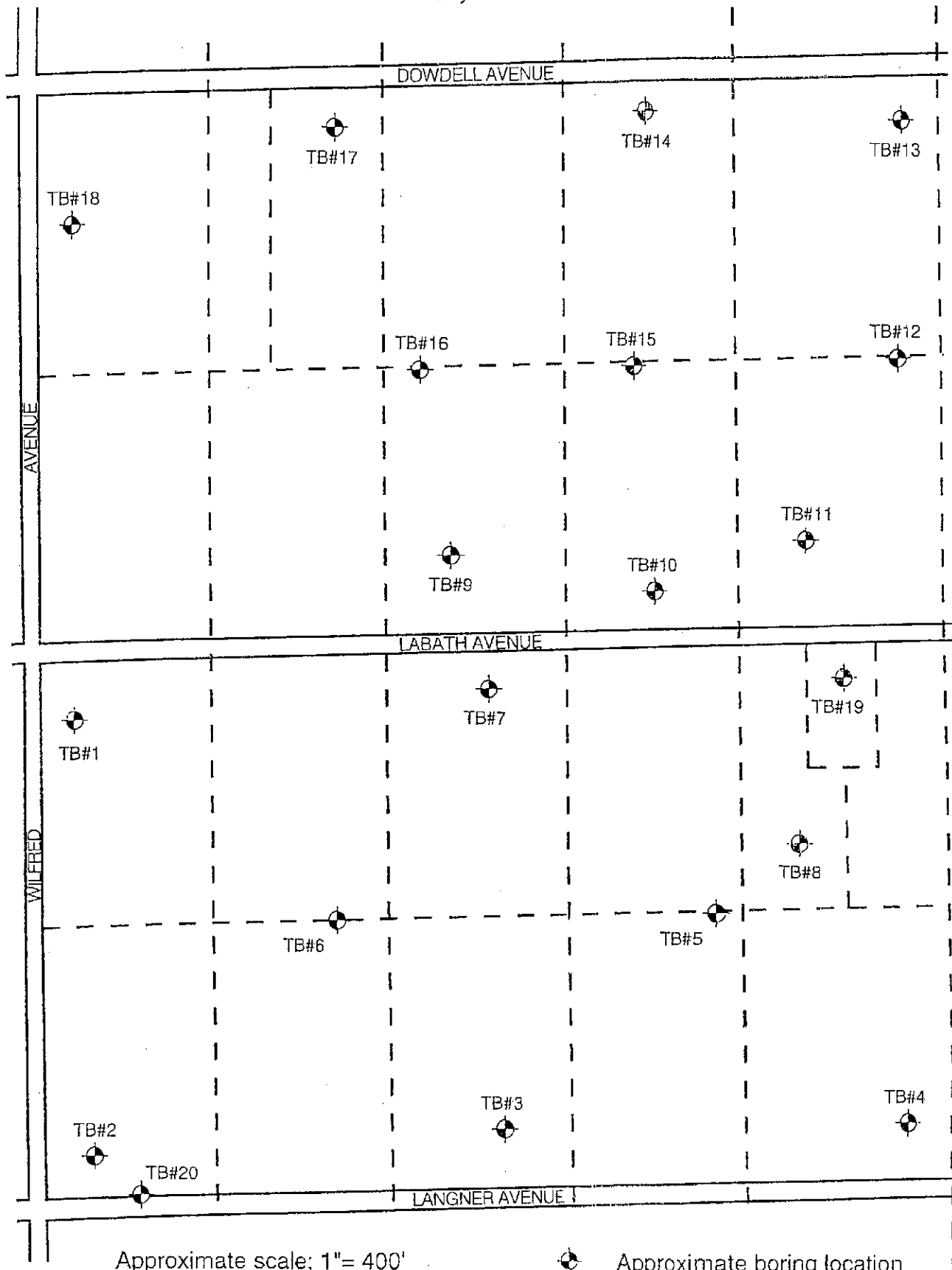
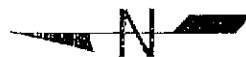

Approximate scale: 1" = 400'

 Approximate boring location

PROJECT			Wilfred Avenue, Rohnert Park				BORING NO. 1				
BORING SUPERVISOR		DC		TYPE OF BORING			DATE OF BORING				
HAMMER WEIGHT		140 pounds, 30 inch drop		6" diameter continuous flight power auger			11/16/04				
SURFACE ELEVATION		Not measured		DEPTH IN FT.	SAMPLE	SAMPLE NUMBER- SAMPLE DIAMETER	DRIVING RESISTANCE BLOWS PER FT.	DRY DENSITY P.C.F.	MOISTURE CONTENT %	UNCONFINED COMPRESSIVE STRENGTH P.S.F.	OTHER TESTS
GROUNDWATER DEPTH		13.0'	ATD								
		9.0'	4-5 hrs/ ATD								
DESCRIPTION OF MATERIALS				DEPTH IN FT.	SAMPLE	SAMPLE NUMBER- SAMPLE DIAMETER	DRIVING RESISTANCE BLOWS PER FT.	DRY DENSITY P.C.F.	MOISTURE CONTENT %	UNCONFINED COMPRESSIVE STRENGTH P.S.F.	OTHER TESTS
Medium stiff dark brown to dark gray brown silty clay				2		1-2.5"	38	-	-	-	Expansion Index  Atterberg Limits
				4		2-2.5"	30/3"	97.5	24.0	7803	
Stiff to very stiff light brown clayey silt to sandy clay				6		3-2.5"	30/6"	100.1	24.6	4586	
				8							
Stiff to very stiff light brown sandy clay				10		4-2.5"	46	104.6	21.8	7166	
				12							
Bottom of boring 15'				14							
				16		5-spt	17	-	-	-	



**PROJECT**

Wilfred Avenue, Rohnert Park

**BORING NO.** 2

**BORING SUPERVISOR** DC

**TYPE OF BORING**  
6" diameter continuous flight auger

**DATE OF BORING**  
11/16/04

**HAMMER WEIGHT** 140 pounds, 30 inch drop

**SURFACE ELEVATION** Not measured

<b>GROUNDWATER DEPTH</b>	12.0'	ATD

**DESCRIPTION OF MATERIALS**

DEPTH IN FT.	SAMPLE	SAMPLE NUMBER- SAMPLE DIAMETER	DRIVING RESISTANCE BLOWS PER FT.	DRY DENSITY P.C.F.	MOISTURE CONTENT %	UNCONFINED COMPRESSIVE STRENGTH P.S.F.	OTHER TESTS
2		1-2.5"	38	94.9	25.6	6815	
4		2-2.5"	32/6"	106.5	20.0	4936	
6							
8							
10		3-spt	18	-	-	-	
12							
14		4-spt	19	-	-	-	
16							

PROJECT		Wilfred Avenue, Rohnert Park					BORING NO. 3				
BORING SUPERVISOR		WG		TYPE OF BORING			DATE OF BORING				
HAMMER WEIGHT		140 pounds, 30 inch drop		6" diameter continuous flight auger			11/16/04				
SURFACE ELEVATION		Not measured		DEPTH IN FT.	SAMPLE	SAMPLE NUMBER- SAMPLE DIAMETER	DRIVING RESISTANCE BLOWS PER FT.	DRY DENSITY P.C.F.	MOISTURE CONTENT %	UNCONFINED COMPRESSIVE STRENGTH P.S.F.	OTHER TESTS
GROUNDWATER DEPTH	Dry	ATD									
DESCRIPTION OF MATERIALS											
Medium stiff to stiff dark brown to dark gray brown silty clay				2		1-2.5"	33	101.4	21.7	8280	
				4							
Stiff light brown clayey silt to sandy clay				6		2-2.5"	34/6"	95.5	25.7	5732	
				8							
Stiff to very stiff light brown sandy silt to sandy clay, becoming sandier with depth				10		3-spt	28	-	-	-	
				12							
				14		4-spt	16	-	-	-	
				16							
Bottom of boring 15'				16							

PROJECT

Wilfred Avenue, Rohnert Park

BORING NO. 4

BORING SUPERVISOR WG

TYPE OF BORING  
6" diameter continuous flight auger

DATE OF BORING  
11/16/04

HAMMER WEIGHT 140 pounds, 30 inch drop

SURFACE ELEVATION Not measured

GROUNDWATER DEPTH	10.5'	ATD
-------------------	-------	-----

DESCRIPTION OF MATERIALS

DEPTH IN FT.	SAMPLE	SAMPLE NUMBER- SAMPLE DIAMETER	DRIVING RESISTANCE BLOWS PER FT.	DRY DENSITY P.C.F.	MOISTURE CONTENT %	UNCONFINED COMPRESSIVE STRENGTH P.S.F.	OTHER TESTS
--------------	--------	-----------------------------------	-------------------------------------	--------------------	-----------------------	--	----------------

Medium stiff to stiff dark brown to dark gray brown silty clay

2

Stiff light gray brown sandy silt to silty clay

4

1-2.5"

43

94.9

25.9

5796

Stiff light brown silty sand to sandy silt, becoming light gray brown to light olive brown in color

6

8

2-2.5"

22/6"

97.5

26.8

5191

Dense to stiff blue gray silty sand to sandy silt

12

3-spt

22

Bottom of boring 13'

14

16





PROJECT

Wilfred Avenue, Rohnert Park

BORING NO. 5

BORING SUPERVISOR

WG

TYPE OF BORING

6" diameter continuous flight auger

DATE OF BORING

11/16/04

HAMMER WEIGHT

140 pounds, 30 inch drop

SURFACE ELEVATION

Not measured

GROUNDWATER DEPTH

9.5'

ATD

DEPTH IN FT.

SAMPLE

SAMPLE NUMBER-  
SAMPLE DIAMETER

DRIVING RESISTANCE  
BLOWS PER FT.

DRY DENSITY P.C.F.

MOISTURE CONTENT  
%

UNCONFINED  
COMPRESSIVE  
STRENGTH P.S.F.

OTHER  
TESTS

DESCRIPTION OF  
MATERIALS

Medium stiff to stiff dark brown to dark gray brown silty clay

2

1-2.5"

42

88.3

44.3

56.5

Dense brown silty clayey medium coarse sand

4

Stiff to very stiff light brown sandy silt to sandy clay

6

2-spt

17

8

Dense light gray brown to yellow brown silty sand with gravel

10

3-spt

31

12

Stiff to dense blue gray silty sand to sandy silt

14

Stiff to very stiff blue gray sandy silt

4-spt

29

Bottom of boring 15'

16

Job No. 04-SR552



Michelucci & Associates, Inc.

Figure 6

PROJECT

Wilfred Avenue, Rohnert Park

BORING NO. 6

BORING SUPERVISOR WG

TYPE OF BORING  
6" diameter continuous flight auger

DATE OF BORING  
11/16/04

HAMMER WEIGHT 140 pounds, 30 inch drop

SURFACE ELEVATION Not measured

GROUNDWATER DEPTH	Dry	ATD

DESCRIPTION OF MATERIALS

DEPTH IN FT.	SAMPLE	SAMPLE NUMBER- SAMPLE DIAMETER	DRIVING RESISTANCE BLOWS PER FT.	DRY DENSITY P.C.F.	MOISTURE CONTENT %	UNCONFINED COMPRESSIVE STRENGTH P.S.F.	OTHER TESTS
2							
4							
6		1-2.5"	32	93.2	27.1	6752	
8							
10							
12		2-spt	13	-	-	-	
14							
16		3-spt	24	-	-	-	

Medium stiff to stiff dark brown to dark gray brown silty clay

Stiff to very stiff light brown sandy silt to sandy clay, becoming stiffer with depth

Stiff blue gray sandy silt to sandy clay with sandier lenses

Bottom of boring 15'

Job No. 04-SR552



Michelucci & Associates, Inc.

Figure 7

PROJECT				Wilfred Avenue, Rohnert Park				BORING NO. 7					
BORING SUPERVISOR			WG			TYPE OF BORING				DATE OF BORING			
HAMMER WEIGHT			140 pounds, 30 inch drop			6" diameter continuous flight auger				11/16/04			
SURFACE ELEVATION			Not measured			DEPTH IN FT.	SAMPLE	SAMPLE NUMBER - SAMPLE DIAMETER	DRIVING RESISTANCE BLOWS PER FT.	DRY DENSITY P.C.F.	MOISTURE CONTENT %	UNCONFINED COMPRESSIVE STRENGTH P.S.F.	OTHER TESTS
GROUNDWATER DEPTH		9.0'		ATD									
DESCRIPTION OF MATERIALS													
Medium stiff to stiff dark brown to dark gray brown silty clay						2							
Stiff light brown sandy silt to sandy clay						4							
Dense light brown silty fine sand						6		1-spl	19	-	-	-	
Stiff to very stiff light brown sandy silt						8							
Dense light brown to gray brown silty medium coarse sand with gravel						10		2-spl	21	-	-	-	
Stiff to dense dark brown to black sandy silt to silty sand						12							
Dense blue gray silty sand to sandy silt, becoming siltier with depth						14		3-spl	36	-	-	-	
Bottom of boring 15'						16							

PROJECT		Wilfred Avenue, Rohnert Park					BORING NO. 8		
BORING SUPERVISOR		WG					TYPE OF BORING		
HAMMER WEIGHT		140 pounds, 30 inch drop					6" diameter continuous flight auger		
SURFACE ELEVATION		Not measured					DATE OF BORING		
GROUNDWATER DEPTH		Dry		ATD		11/16/04			
DESCRIPTION OF MATERIALS		DEPTH IN FT.	SAMPLE	SAMPLE NUMBER-SAMPLE DIAMETER	DRIVING RESISTANCE BLOWS PER FT.	DRY DENSITY P.C.F.	MOISTURE CONTENT %	UNCONFINED COMPRESSIVE STRENGTH P.S.F.	OTHER TESTS
Medium stiff dark brown sandy clay (Possible Fill)		2		1-2.5"	26	102.3	21.9	6274	
Medium stiff to stiff dark brown to dark gray brown silty clay to sandy clay (Native)		4		2-2.5"	44	86.7	30.8	9395	
Stiff to very stiff light brown to tan sandy silt to sandy clay		6							
Bottom of boring 4.5'		6							
		8							
		10							
		12							
		14							
		16							



PROJECT			Wilfred Avenue, Rohnert Park				BORING NO. 9				
BORING SUPERVISOR		DC		TYPE OF BORING			DATE OF BORING				
HAMMER WEIGHT		140 pounds, 30 inch drop		6" diameter continuous flight auger			11/17/04				
SURFACE ELEVATION		Not measured		DEPTH IN FT.	SAMPLE	SAMPLE NUMBER- SAMPLE DIAMETER	DRIVING RESISTANCE BLOWS PER FT.	DRY DENSITY P.C.F.	MOISTURE CONTENT %	UNCONFINED COMPRESSIVE STRENGTH P.S.F.	OTHER TESTS
GROUNDWATER DEPTH	12.0'	ATD	10.5'								
DESCRIPTION OF MATERIALS											
Medium stiff to stiff dark brown to dark gray brown silty clay				2		1-2.5"	34	83.0	33.2	4363	
				4							
Stiff to very stiff light brown clayey silt to sandy silt				6		2-2.5"	25/2"	-	19.0	-	
				8							
Dense brown silty gravelly sand to gravelly sandy silt				10		3-spt	45/6"	-	-	-	
				12							
Stiff light brown clayey silt to clayey sandy silt				14		4-spt	16	-	-	-	
				16							
Bottom of boring 15'											



PROJECT				Wilfred Avenue, Rohnert Park				BORING NO. 10				
BORING SUPERVISOR			DC		TYPE OF BORING			DATE OF BORING				
HAMMER WEIGHT			140 pounds, 30 inch drop		6" diameter continuous flight auger			11/17/04				
SURFACE ELEVATION			Not measured		DEPTH IN FT.	SAMPLE	SAMPLE NUMBER- SAMPLE DIAMETER	DRIVING RESISTANCE BLOWS PER FT.	DRY DENSITY P.C.F.	MOISTURE CONTENT %	UNCONFINED COMPRESSIVE STRENGTH P.S.F.	OTHER TESTS
GROUNDWATER DEPTH		9.0'	ATD									
DESCRIPTION OF MATERIALS												
Medium stiff to stiff dark brown to dark gray brown silty clay				2	1-2.5"	25	91.4	28.5	3503			
				4	2-2.5"	20/6"	103.2	21.9	5064			
Stiff light brown sandy silt to clayey silt with some small pebbles (1/4" to 3/8")				6								
				8								
Dense brown gravelly silty sand (gravels up to 1")				10	3-spt	25/3"	-	-	-			
				12								
Stiff light brown clayey silt to sandy silt				14								
					4-spl	29	-	-	-			
Bottom of boring 15'				16								



PROJECT

Wilfred Avenue, Rohnert Park

BORING NO. 11

BORING SUPERVISOR DC

TYPE OF BORING  
6" diameter continuous flight auger

DATE OF BORING  
11/17/04

HAMMER WEIGHT 140 pounds, 30 inch drop

SURFACE ELEVATION Not measured

GROUNDWATER DEPTH  
Dry ATD

DESCRIPTION OF MATERIALS

DEPTH IN FT.

SAMPLE

SAMPLE NUMBER-  
SAMPLE DIAMETER

DRIVING RESISTANCE  
BLOWS PER FT.

DRY DENSITY P.C.F.

MOISTURE CONTENT  
%

UNCONFINED  
COMPRESSIVE  
STRENGTH P.S.F.

OTHER  
TESTS

Medium stiff dark brown silty clay with debris (Fill)

2

1-2.5"

25/6"

101.1

16.6

11,000+

Medium stiff dark brown to dark gray brown silty clay (Native)

4

2-2.5"

25/6"

88.2

30.9

5255

Stiff to very stiff light brown sandy silt to clayey silt

6

Bottom of boring 2.5'

8

10

12

14

16



PROJECT				Wilfred Avenue, Rohnert Park				BORING NO. 12				
BORING SUPERVISOR			DC		TYPE OF BORING			DATE OF BORING				
HAMMER WEIGHT			140 pounds, 30 inch drop		6" diameter continuous flight auger			11/17/04				
SURFACE ELEVATION			Not measured		DEPTH IN FT.	SAMPLE	SAMPLE NUMBER- SAMPLE DIAMETER	DRIVING RESISTANCE BLOWS PER FT.	DRY DENSITY P.C.F.	MOISTURE CONTENT %	UNCONFINED COMPRESSIVE STRENGTH P.S.F.	OTHER TESTS
GROUNDWATER DEPTH		11.0'	ATD	9.0'								
DESCRIPTION OF MATERIALS												
Medium stiff to stiff dark brown to dark gray brown silty clay			2		1-2.5"	57	104.7	19.9	11,000+			
			4		2-2.5"	28	91.0	30.0	4140			
Stiff light brown clayey silt to sandy silt			6		3-spt	17	-	-	-			
			8		4-spt	36	-	-	-			
Dense brown silty sand to clayey sand			10									
			12									
Bottom of boring 13'			14									
			16									





PROJECT

Wilfred Avenue, Rohnert Park

BORING NO. 13

BORING SUPERVISOR WG

TYPE OF BORING  
6" diameter continuous flight auger

DATE OF BORING  
11/17/04

HAMMER WEIGHT 140 pounds, 30 inch drop

SURFACE ELEVATION Not measured

GROUNDWATER DEPTH	Dry	ATD

DESCRIPTION OF MATERIALS

DEPTH IN FT.	SAMPLE	SAMPLE NUMBER- SAMPLE DIAMETER	DRIVING RESISTANCE BLOWS PER FT.	DRY DENSITY P.C.F.	MOISTURE CONTENT %	UNCONFINED COMPRESSIVE STRENGTH P.S.F.	OTHER TESTS
--------------	--------	--------------------------------	----------------------------------	--------------------	--------------------	--	-------------

2		1-2.5"	42	-	-	-	Atterberg Limits
4		2-2.5"	28/6"	96.9	24.8	7198	

6						
8						
10		3-spt	10	-	-	-
12						
14		4-spt	29	-	-	-

16							
Bottom of boring 15'							



PROJECT			Wilfred Avenue, Rohnert Park				BORING NO. 14					
BORING SUPERVISOR		WG		TYPE OF BORING			DATE OF BORING					
HAMMER WEIGHT		140 pounds, 30 inch drop		6" diameter continuous flight auger			11/17/04					
SURFACE ELEVATION		Not measured		DEPTH IN FT.	SAMPLE	SAMPLE NUMBER- SAMPLE DIAMETER	DRIVING RESISTANCE BLOWS PER FT.	DRY DENSITY P.C.F.	MOISTURE CONTENT %	UNCONFINED COMPRESSIVE STRENGTH P.S.F.	OTHER TESTS	
GROUNDWATER DEPTH		9.5' ATD										
DESCRIPTION OF MATERIALS												
Medium stiff to stiff dark brown to dark gray brown silty clay				2								
					1-2.5"	50	86.1	30.6	4338			
Stiff to very stiff light brown sandy silt with some clay				4								
					2-2.5"	44	92.3	27.8	5892			
				6								
					3-spt	16	-	-	-			
Stiff to dense light brown sandy silt to silty sand, becoming siltier and stiffer below 11' to 12'				8								
				10								
					4-spt	44/9"	-	-	-			
Bottom of boring 14'				12								
				14								
				16								



PROJECT			Wilfred Avenue, Rohnert Park				BORING NO. 15					
BORING SUPERVISOR		WG		TYPE OF BORING			DATE OF BORING					
HAMMER WEIGHT		140 pounds, 30 inch drop		6" diameter continuous flight auger			11/17/04					
SURFACE ELEVATION		Not measured		DEPTH IN FT.	SAMPLE	SAMPLE NUMBER- SAMPLE DIAMETER	DRIVING RESISTANCE BLOWS PER FT.	DRY DENSITY P.C.F.	MOISTURE CONTENT %	UNCONFINED COMPRESSIVE STRENGTH P.S.F.	OTHER TESTS	
GROUNDWATER DEPTH		11.0' ATD										
DESCRIPTION OF MATERIALS												
Medium stiff to stiff dark brown to dark gray brown silty clay				2		1-2.5"	29	71.8	41.6	-		
				4								
Stiff to very stiff light brown sandy silt with occasional sandier layers				6		2-2.5"	34	90.5	30.5	4842		
				8								
				10		3-spt	25	-	-	-		
				12								
Dense brown to gray brown silty coarse sand with pebbles				14								
						4-spt	38/6"					
Bottom of boring 14.5'				16								



PROJECT				Wilfred Avenue, Rohnert Park				BORING NO. 16					
BORING SUPERVISOR			WG			TYPE OF BORING				DATE OF BORING			
HAMMER WEIGHT			140 pounds, 30 inch drop			6" diameter continuous flight auger				11/17/04			
SURFACE ELEVATION			Not measured			DEPTH IN FT.	SAMPLE	SAMPLE NUMBER-SAMPLE DIAMETER	DRIVING RESISTANCE BLOWS PER FT.	DRY DENSITY P.C.F.	MOISTURE CONTENT %	UNCONFINED COMPRESSIVE STRENGTH P.S.F.	OTHER TESTS
GROUNDWATER DEPTH		Dry	ATD										
DESCRIPTION OF MATERIALS													
Medium stiff to stiff dark brown to dark gray brown silty clay						2	1-2.5"	41	91.7	28.5	7389		
Stiff to very stiff light brown sandy silt to sandy clay						4	2-2.5"	50	-	15.0	-		
Dense to very dense brown to gray brown silty fine sand to medium coarse sand						6	3-2.5"	34/6"	103.8	-22.8	4395		
Stiff to very stiff light brown sandy silt with some clay						8							
Bottom of boring 12'						10							
						12							
						14							
						16							



PROJECT

Wilfred Avenue, Rohnert Park

BORING NO. 17

BORING SUPERVISOR DC

TYPE OF BORING  
8.0 inch diameter hollow stem auger

DATE OF BORING  
12/21/04

HAMMER WEIGHT 140 pounds, 30 inch drop

SURFACE ELEVATION Not measured

GROUNDWATER DEPTH 9.5' ATD

DESCRIPTION OF MATERIALS

DEPTH IN FT.	SAMPLE	SAMPLE NUMBER- SAMPLE DIAMETER	DRIVING RESISTANCE BLOWS PER FT.	DRY DENSITY P.C.F.	MOISTURE CONTENT %	UNCONFINED COMPRESSIVE STRENGTH P.S.F.	OTHER TESTS
--------------	--------	-----------------------------------	-------------------------------------	--------------------	-----------------------	--	----------------

Medium stiff dark brown to black silty clay  
(approximately 3" of imported gray gravel at surface)

5

Stiff light gray brown to brown sandy clayey silt  
with more sandy lenses

10

Stiff blue gray silty clay with minor sand

15

Stiff blue gray sandy silt with minor clay  
lenses

20

Stiff blue gray silty sandy clay to silty  
clay

25

Medium stiff blue gray silty clay

30

Bottom of boring 32'

35

1) 2"	56/9"	96.4	24.2	3807
2) 2"	22	91.8	30.8	4315
3) spt	19	-	-	-
4) spt	20	-	-	-
5) spt	11	-	-	-
6) spt	14	-	-	-



PROJECT

Wilfred Avenue, Rohnert Park

BORING NO. 18

BORING SUPERVISOR DC

TYPE OF BORING  
8.0 inch diameter hollow stem auger

DATE OF BORING  
12/21/04

HAMMER WEIGHT 140 pounds, 30 inch drop

SURFACE ELEVATION Not measured

GROUNDWATER DEPTH	10.0'	ATD
	6.5'	1hr/ATD

DESCRIPTION OF MATERIALS

DEPTH IN FT.

SAMPLE

SAMPLE NUMBER-  
SAMPLE DIAMETER

DRIVING RESISTANCE  
BLOWS PER FT.

DRY DENSITY P.C.F.

MOISTURE CONTENT  
%

UNCONFINED  
COMPRESSIVE  
STRENGTH P.S.F.

OTHER  
TESTS

Medium stiff dark brown to black silty clay

5

Stiff light brown to tan sandy silt to clayey silt



1) 2"

43

97.4

24.1

4162

Dense gray brown gravelly silty sand

10



2) 2"

42

98.3

24.4

508

Dense gray brown silty sand with lenses of light gray brown clayey silt

15

3) spt

82

-

-

-

Dense gray brown silty sand

20

4) spt

19

-

-

-

Stiff blue gray clayey silt to silty clay

25

5) spt

11

-

-

-

Dense blue gray clayey and to silty clayey sand

30

6) spt

30

-

-

-

Bottom of boring 31.5'

35

Job No. 04-SR552



Michelucci & Associates

Figure 19

PROJECT			Wilfred Avenue, Rohnert Park				BORING NO. 19			
BORING SUPERVISOR		DC		TYPE OF BORING			DATE OF BORING			
HAMMER WEIGHT		140 pounds, 30 inch drop		8.0 inch diameter hollow stem auger			12/21/04			
SURFACE ELEVATION		Not measured		DEPTH IN FT.	SAMPLE NUMBER- SAMPLE DIAMETER	DRIVING RESISTANCE BLOWS PER FT.	DRY DENSITY P.C.F.	MOISTURE CONTENT %		
GROUNDWATER DEPTH		10.0' ATD							UNCONFINED COMPRESSIVE STRENGTH P.S.F.	OTHER TESTS
DESCRIPTION OF MATERIALS										
Medium stiff dark brown to black silty clay										
Stiff light gray brown to tan sandy clayey silt with more sandy lenses				5						
					1) 2"	39	96.8	24.3	5330	
(Some minor gravels at 13' to 14')				10						
					2) 2"	20	94.8	29.4	4213	
Stiff tan sandy silt to clayey silt				15						
Stiff blue gray silty clay to sandy clay with more sandy lenses					3) spt	16	96.3	29.2	4213	
				20						
					4) spt	21	-	-	-	
				25						
					5) spt	19	-	-	-	
Bottom of boring 31.5'				30						
					6) spt	12	-	-	-	
				35						

Job No. 04-SR552



**Michelucci & Associates**

Figure 20

PROJECT

Wilfred Avenue, Rohnert Park

BORING NO. 20

BORING SUPERVISOR DC

TYPE OF BORING  
8.0 inch diameter hollow stem auger

DATE OF BORING  
12/21/04

HAMMER WEIGHT 140 pounds, 30 inch drop

SURFACE ELEVATION Not measured

GROUNDWATER DEPTH 10.0' ATD

DESCRIPTION OF MATERIALS

DEPTH IN FT.

SAMPLE

SAMPLE NUMBER-  
SAMPLE DIAMETER

DRIVING RESISTANCE  
BLOWS PER FT.

DRY DENSITY P.C.F.

MOISTURE CONTENT  
%

UNCONFINED  
COMPRESSIVE  
STRENGTH P.S.F.

OTHER  
TESTS

Medium stiff to stiff dark brown silty clay  
(AC and approximately 6" imported base  
rock at surface)

5

Stiff light gray brown to tan clayey sandy  
silt, becoming gravelly between 7' and 9.5'

10



15

Stiff blue gray to gray green silty clay to clayey  
silt with lenses of sandy clay to clayey sand

1) 2"

14

20

2) 2"

19

25

Stiff blue gray silty clay with more sandy lenses

3) spt

11

30

4) spt

14

Bottom of boring 31.5'

35

Job No. 04-SR552



Michelucci & Associates

Figure 21



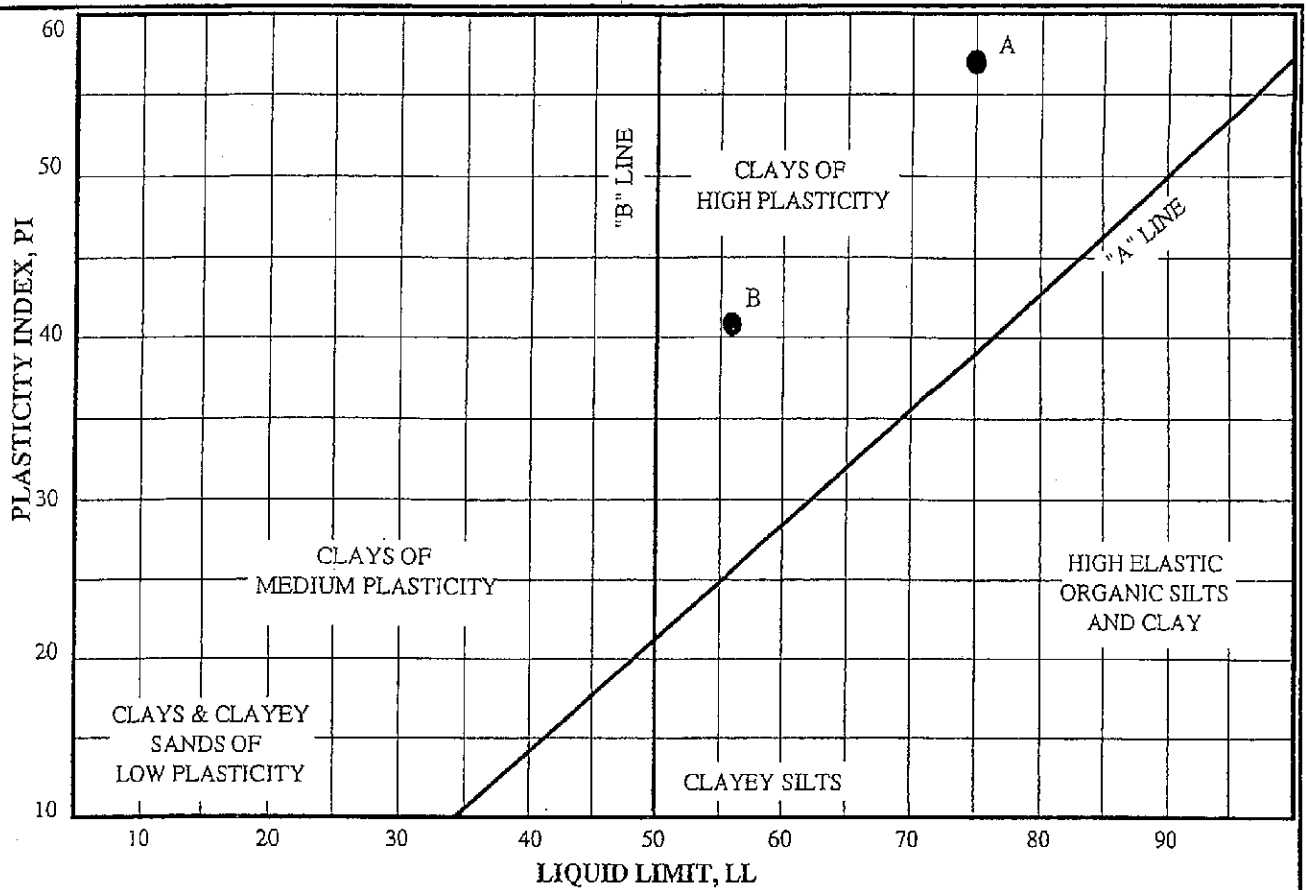

CLASSIFICATION TEST RESULTS									
SAMPLE IDENTIFICATION			ATTERBERG LIMITS			GRAIN SIZES % DRY WT.			
SAMPLE	LETTER DESIGNATION	DESCRIPTION	LIQUID LIMIT	PLASTICITY INDEX	SHRINKAGE LIMIT	SAND	SILT	CLAY	COLLOIDAL
1-1-4	A	Dark brown to dark gray brown silty clay	75	57					
13-1-4	B	Dark brown to dark gray brown silty clay	56	41					

PLASTICITY CLASSIFICATION



# UBC EXPANSION INDEX

Wilfred Avenue

Rohnert Park California

Sample: Bulk Sample Adjacent to  
Boring #1

Description: Dark brown to dark  
gray brown silty clay

## Initial

Sample Height (in):	1.0000
Moisture Content (%):	18.3
Dry Density (pcf):	80.8
Void Ratio:	1.083
Saturation (%):	45.5

## Final

Sample Height (in):	1.1282
Moisture Content (%):	47.9
Void Ratio:	1.354
Saturation (%):	95.6

Expansion Index: 123

Expansion Index Level: HIGH

## EXPANSION INDEX LEVELS:

0-20= Very Low  
21-50= Low  
51-90= Medium  
91-130= High  
>130= Very High



**GUIDE SPECIFICATIONS FOR SUBDRAINS BEHIND RETAINING WALLS**

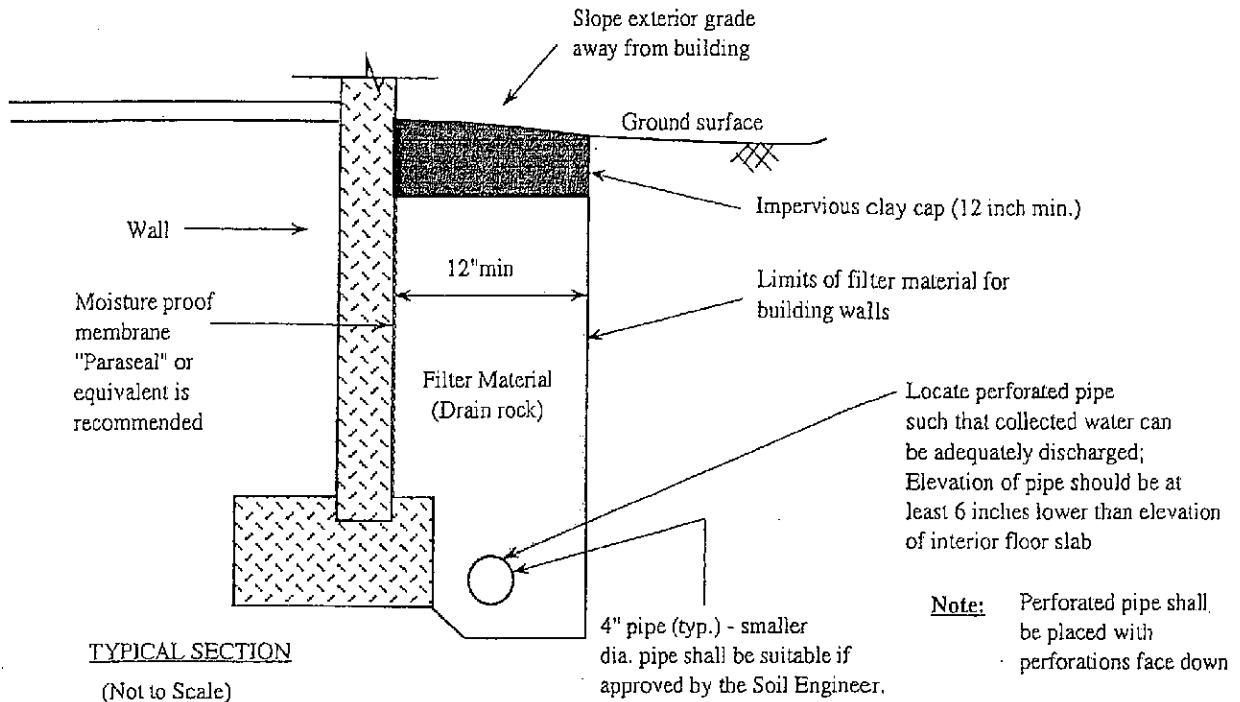

Subdrain pipe shall be manufactured in accordance with the following requirements:

- a. Acrylonitrile-butadiene-styrene (ABS) plastic pipe shall conform to the specifications for ABS plastic pipe given in ASTM Designation D2282 and ASTM Designation D2751. ABS pipe shall have a minimum pipe stiffness of 45 psi at 5% deflection when measured in accordance with ASTM Method D2412.
- b. Polyvinyl chloride (PVC) pipe shall conform to AASHTO Designation M278. PVC pipe shall have a minimum pipe stiffness of 50 psi at 5% deflection when measured in accordance with ASTM Method D2412 except that pipe conforming to F758 shall be suitable. Schedule 40 PVC pipe shall be suitable. SDR-35 PVC pipe conforming to ASTM D3034 shall be suitable when the thickness of pipe cover does not exceed 12 feet.

Filter material for use in backfilling trenches around and over subdrain pipes and behind retaining walls shall consist of clean coarse sand and gravel or crushed stone conforming to the following requirements:

Sieve Size	% Passing Sieve
2"	100
3/4"	70 to 100
3/8"	40 to 100
#4	25 to 50
#8	15 to 45
#30	5 to 25
#50	0 to 20
#200	0 to 3

Class 2 "Permeable Material" conforming to the State of California Department of Transportation Standard Specifications, latest edition, Section 68-1.025 shall be suitable.

Clean, coarse gravel ("drain rock") shall be suitable, provided the subsurface drain is wrapped in an acceptable geotextile ("filter fabric") such as Mirafi 140N.



## MOISTURE RETARDANT BENEATH CONCRETE FLOOR SLABS TYPICAL SECTION

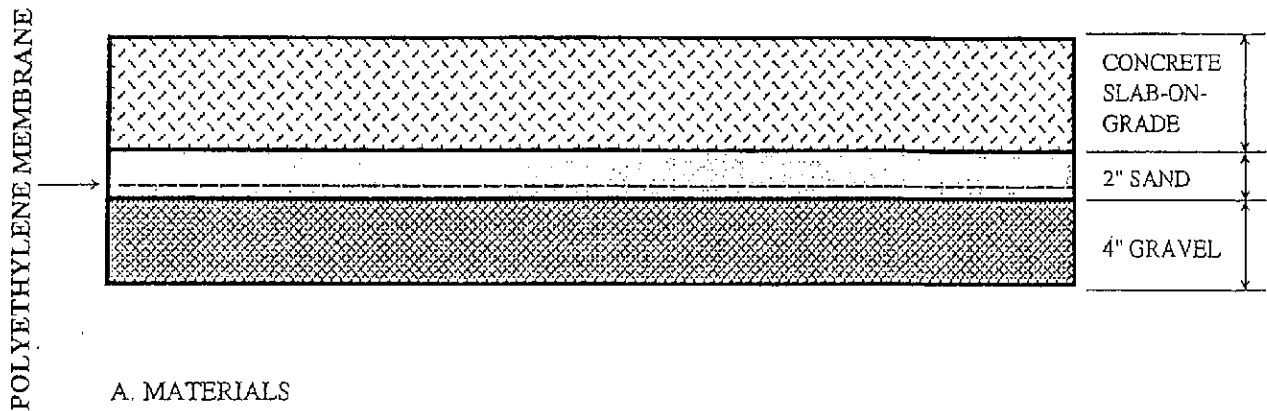

### A. MATERIALS

The mineral aggregate for use under floor slabs shall consist of clean rounded gravel and sand. The aggregate shall be free from clay, organic matter, loam, volcanic tuff, and other deleterious substances.

### B. GRADATIONAL REQUIREMENTS

The mineral aggregate shall consist of such sizes that the percentage composition by dry weight as determined by laboratory sieve (U.S. Series) will conform to the following gradation:

Sieve Size	Percentage Passing	
	Gravel	Sand
1"	100	
3/4"	90-100	
No. 4	0-5	100
No. 50		0-30

### NOTES:

1. The polyethylene membrane should be adequately thick so that it will not be easily damaged during construction. It should be adequately detailed so that there are little or no openings around plumbing at conduit points and near foundations. Pipe penetrations should be taped to minimize vapor transmission. The membrane sheets should be adequately lapped.
2. The sand covering is not a part of the moisture retardant treatment. It is a normally used optional component that gives some protection to the membrane and also aids in curing the concrete. Pea gravel may be used as a substitute for sand.
3. The final moisture retardant detail is to be determined by the project architect.

**GUIDE SPECIFICATIONS  
FOR ENGINEERED FILL**

Page 1 - Job. No. 04-SR552

**A. GENERAL**

**1. Definition of Terms**

**FILL**...is all soil or soil/rock materials placed to raise the grade of the site or to backfill excavations.

**ON-SITE MATERIAL**...is that which is obtained from the required excavations on the site.

**IMPORT MATERIAL**...is that hauled in from off-site areas.

**SELECT MATERIAL**...is a soil material meeting the requirements set forth in "C(2)" below.

**ENGINEERED FILL**...is a fill upon which the Soil Engineer has made sufficient test and observations to enable him to issue a written statement that in his opinion the fill has been placed and compacted in accordance with the specification requirements.

**AASHTO SPECIFICATIONS**...are the Standard Specifications of the American Association of State Highway Officials latest revision.

**ASTM SPECIFICATIONS**...are the Annual Book of ASTM Standards (Part 19), American Society for Testing and Materials, latest revision.

**MAXIMUM LABORATORY DENSITY**...is the maximum density for a given fill material that can be produced in the laboratory by the Standard procedure ASTM D1557, "Moisture-Density Relations of Soils Using a 10-Pound (4.5 kg) Hammer and an 18-inch (457 mm) Drop" (AASHTO Test T-180, "Moisture-Density Relations of Soils Using 10-Pound Hammer and an 18-Inch Drop").

**OPTIMUM MOISTURE CONTENT**...is the moisture content at which the maximum laboratory density is achieved using the standard compaction procedure ASTM Test Designation D1557 (AASHTO Test -180).

**DEGREE OF COMPACTION**...is the ratio, expressed as a percentage, of the dry density of the fill material as compacted in the field to the maximum dry density for the same material.

## **GUIDE SPECIFICATIONS**

### **FOR ENGINEERED FILL**

Page 2 - Job. No. 04-SR552

#### **2. Responsibility of the Soil Engineer**

The Soil Engineer shall be the Owner's representative to observe the grading operations, both during preparation of the site and compaction of any engineered fill. He shall make enough visits to the site to familiarize himself generally with the progress and quality of the work. He shall make a sufficient number of field observations and tests to enable him to form an opinion regarding the adequacy of the site preparation, the acceptability of the fill material, and the extent to which the degree of compaction meets the specification requirements. Any fill where the site preparation, type of material, or compaction is not approved by the Soil Engineer shall be removed and/or recompacted until the requirements are satisfied.

#### **3. Soil Conditions**

A soil investigation has been performed for the site by Michelucci & Associates and a report has been issued by them dated June 30, 2005 covering that investigation. The contractor shall familiarize himself with the soil conditions on the site, whether covered in that report or not, and shall thoroughly understand all recommendations associated with the grading.

### **B. SITE PREPARATION**

#### **1. Stripping**

Prior to any cutting or filling, the site shall be stripped to a sufficient depth to remove all grass, weeds, roots, and other vegetation, including trees and their root systems. The minimum stripping depth shall be 3 inches. The site shall be stripped to such greater depth as the Soil Engineer in the field may consider necessary to remove materials that, in his opinion, are unsatisfactory. The stripped material shall either be removed from the site or stockpiled for reuse later as topsoil, but none of this stripped material may be used for engineered fill.

When trees are removed, the soils loosened by the roots shall be overexcavated at least to the bottom of the disturbed zone and to the width of the equipment. These excavations should be backfilled with engineered fill.

## GUIDE SPECIFICATIONS

### FOR ENGINEERED FILL

Page 3 - Job. No. 04-SR552

#### **2. Preparation for Filling**

After stripping, the weak soils in areas to be filled or in building footprint areas plus 5 feet beyond building lines shall be overexcavated to the minimum depth called for on the plans or that is required by the Soil Engineer in the field. The overexcavated soils that are clean and free from organic material can be used later as general engineered fill.

After stripping the surface vegetation and overexcavating the weak soils to the required depths, the exposed surface shall be scarified to a minimum depth of 6 inches, watered or aerated as necessary to bring the soil to a moisture content that will permit compaction, and recompact to the requirements of engineered fill as specified in "D" below. Prior to placing fill, the Contractor shall obtain the Soil Engineer's approval of the site preparation in the area to be filled. The requirements of this section may be omitted only when approved in writing by the Soil Engineer.

#### **C. MATERIAL USED FOR FILL**

##### **1. Requirements for General Engineered Fill**

All fill material must be approved by the Soil Engineer. The material shall be a soil or soil/rock mixture that is free of organic matter or other deleterious substances. The fill material shall not contain rocks or lumps over 6 inches in greatest dimension, and not more than 15% by dry weight shall be larger than 2 1/2 inches in greatest dimension. The soils from the site, except the surface strippings, shall be suitable for use as fill.

##### **2. Requirements for Select Fill Material Beneath Floor Slabs**

In addition to the requirements of "C(1)" above, select material, when called for on the plans and for use under floor slabs or in buttress fills, must conform to the following minimum requirements:

**GUIDE SPECIFICATIONS  
FOR ENGINEERED FILL**

Page 4 - Job. No. 04-SR552

Maximum Plasticity Index

12

**3. Environmental Certification for Imported Fill**

All imported fill materials, to be used as a select material or otherwise, shall be free from hazardous contaminants and other refuse. The contractor shall provide to the owner proper certification and other documentation as required by the owner to verify that the imported material is not contaminated with hazardous substances. The acceptable levels of any contaminants discovered in the soil shall be determined by the owner.

**D. PLACING AND COMPACTING FILL MATERIAL**

All fill material shall be compacted as specified below or by other methods, if approved by the Soil Engineer, so as to produce a minimum degree of compaction of 90%. Fill material shall be spread in uniform lifts not exceeding 8 inches in uncompacted thickness.

Before compaction begins, the fill shall be brought to a water content that will permit proper compaction by either aerating the material if it is too wet or spraying the material with water if it is too dry. Each lift shall be thoroughly mixed before compaction to ensure a uniform distribution of water content. Where natural clayey soils are used within 3 feet of the finished ground surface, they shall be placed and compacted at a moisture content that is 1% to 3% above optimum.

**E. EXCAVATION**

All excavations shall be carefully made true to the grades and elevations shown on the plans. The excavated surfaces shall be properly graded to provide good drainage during construction and to prevent ponding of water.



**GUIDE SPECIFICATIONS  
FOR ENGINEERED FILL**

Page 5 - Job. No. 04-SR552

**F. SUBGRADE PREPARATION UNDER FLOOR SLABS**

The floor slab area shall be overexcavated to a sufficient depth to accommodate a 30-inch thickness of select fill, when called for by the soil engineer. After overexcavating, the exposed surface shall be scarified, mixed with water, if necessary, and compacted to a degree of compaction of 90% at a moisture content 1% to 3% above optimum. The select engineered fill shall be placed immediately to prevent drying up of the subgrade. The select fill shall be placed and compacted as in "D" above.

**G. TREATMENT AFTER COMPLETION OF GRADING**

After grading is completed and the Soil Engineer has finished his observation of the work, no further excavation or filling shall be done except with the approval of and under the observation of the Soil Engineer. It shall be the responsibility of the Grading Contractor to prevent erosion of freshly graded areas during construction and until such time as permanent drainage and erosion control measures have been installed.

**GUIDE SPECIFICATIONS  
FOR SUBSURFACE DRAINS**

Page 1 - Job No. 04-SR552

**A. DESCRIPTION**

Subsurface drains are pipes installed beneath the ground surface and which collect and convey subsurface drainage water. Unless otherwise directed by the Soil Engineer in the field, the conduit shall be placed in a trench, and the trench shall be backfilled with pervious material. The conduit and pervious material shall meet the requirements for the materials given in these specifications. The materials for the subsurface drain and the size of the trench shall be as shown on the plans or as determined by the Soil Engineer in the field.

**B. MATERIALS**

**1. Subdrain Pipe**

Subdrain pipe shall be manufactured in accordance with the following requirements:

a. Perforated corrugated metal pipe shall conform to the specifications of AASHTO Designation M36. Corrugated steel sheet used in the fabrication of the pipe shall have a protective coating of zinc (galvanizing), aluminum, or aluminum-zinc alloy conforming to ASTM Designation A760.

b. Acrylonitrile-butadiene-styrene (ABS) plastic pipe shall conform to the specifications for ABS plastic pipe given in ASTM Designation D2282 and ASTM Designation D2751. ABS pipe shall have a minimum pipe stiffness of 45 psi at 5% deflection when measured in accordance with ASTM Method D2412.

**GUIDE SPECIFICATIONS  
FOR SUBSURFACE DRAINS**

Page 2 - Job No. 04-SR552

c. Polyvinyl chloride (PVC) pipe shall conform to ASSHTO Designation M278. PVC pipe shall have a minimum pipe stiffness of 50 psi at 5% deflection when measured in accordance with ASTM Method D2412. Schedule 40 PVC pipe shall be suitable.

**2. Pervious Backfill Material**

Pervious materials for use in backfilling trenches shall conform to the requirements of Paragraph "C1" of these specifications. Pervious material conforming to the requirements of Paragraph "C2" may be used, provided that the backfill is wrapped in a suitable geotextile ("filter fabric") meeting the requirements given in Section "D".

**C. BACKFILL MATERIAL**

**1. Filter Material**

Filter material for use in backfilling trenches around and over subdrain pipes and behind retaining walls shall consist of clean coarse sand and gravel or crushed stone conforming to the following requirements:

<u>Sieve Size</u>	<u>% Passing Sieve</u>
2"	100
3/4"	70 to 100
3/8"	40 to 100
# 4	25 to 50
# 8	15 to 45

**GUIDE SPECIFICATIONS  
FOR SUBSURFACE DRAINS**

Page 3 - Job No. 04-SR552

#30	0 to 40
#50	0 to 20
#200	0 to 3

Class 2 "permeable material" conforming to the State of California Department of Transportation Standard Specifications, latest edition, Section 68-1.025 shall be suitable.

**2. Gravel**

Gravel for use in pervious blankets and in backfilling trenches or wrapped in filter fabric meeting the requirements of Section D of these specifications shall consist of clean fresh stone conforming to the following grading requirements:

<u>Sieve Size</u>	<u>% Passing Sieve</u>
.1"	100
1/2"	50 to 100
#4	40 to 100
#8	0 to 40
#30	0 to 40
#50	0 to 5
#200	0 to 3

**GUIDE SPECIFICATIONS  
FOR SUBSURFACE DRAINS**

Page 4 - Job No. 04-SR552

Class 1 "permeable material" conforming to the State of California Department of Transportation Standard Specifications Section 68-1.025 shall be suitable.

**D. GEOTEXTILE**

Geotextiles for use in subdrains or as directed by the Soil Engineer shall be of nonwoven, needlepunch construction and consist of long chain polymeric fibers composed of polypropylene, polyethylene, or polyamide. The fibers shall be oriented into a multidirectional, stable network. The geotextile shall conform to the physical property requirements listed below:

<u>Physical Property</u>	<u>Test Method</u>	<u>Acceptable Typical Test Results</u>
Tensile Strength, wet, lbs	ASTM D1682	90 (minimum)
Elongation, wet, %	ASTM D1682	40 (minimum)
Coefficient of Water Permeability, cm/sec	Constant Head	0.10 (minimum)
Pore Size--EOS, U.S. Standard Sieve	Corps of Engineers CW-02215	40 (maximum)

**GUIDE SPECIFICATIONS**  
**FOR SUBSURFACE DRAINS**

Page 5 - Job No. 04-SR552

**E. LAYING AND PLACEMENT**

The drain pipe and filter material shall be placed as shown on the plans or as determined by the Soil Engineer in the field. Unless otherwise directed by the Soil Engineer, perforated pipe shall be laid with the perforations at the bottom. Corrugated metal pipe sections shall be joined with couplers.

Subsurface drains shall be placed to the depths, lines, and grades shown on the plans and as directed by the Soil Engineer in the field. Subsurface drains shall discharge to a suitable outlet as defined in the field by the Soil Engineer or as shown on the plans.

After excavating the subsurface drain trench but before placing the drain pipe, a minimum of 4 inches of filter material shall be placed on the trench bottom. The filter material shall be rounded to conform to the curvature of the pipe so that the pipe is carefully bedded. The trench shall then be backfilled to the top of the pipe, and the backfill tamped or hand wedged into place to provide firm support at the sides of the pipe. In general, the installation shall follow the guidelines of ASTM Designation D2774, except that compaction of the filter material in the trench shall not be required.

The contractor shall, at his expense, replace pipes damaged during the installation or subsurface drains not placed at the lines and grades called for on the plans or as determined by the Soil Engineer in the field.

The geotextile shall be placed in the manner and at the locations shown on the plans. The surface to receive the fabric and/or the trench into which the fabric is to be placed shall be prepared to a smooth condition free of obstructions and debris.

The geotextile shall be covered with a permeable material within two weeks of its placement. Should the fabric be damaged

**GUIDE SPECIFICATIONS  
FOR SUBSURFACE DRAINS**

Page 6 - Job No. 04-SR552

during construction, the torn or punctured section shall be repaired by placing a piece of fabric that is large enough to cover the damaged area and to meet the overlap requirement. Adjacent borders of the geotextile shall be overlapped a minimum of 12 inches or sewn. The preceding roll shall overlap the following roll in the direction the material is being placed.

**F. CLEANOUTS**

At the direction of the Soil Engineer, cleanouts shall be provided at the ends of pipes and at junctions and connections of pipelines. Junction angles should be no steeper than 45 degrees where cleanout pipes connect to the subdrain pipes. Cleanouts should be provided with lockable caps.